

Nouvelle

Collection

Edition 2024



SONO  LYS



Découpe et gravure

Laser cutting and engraving.

Laser



Impression

Transfert

Dye sublimation print

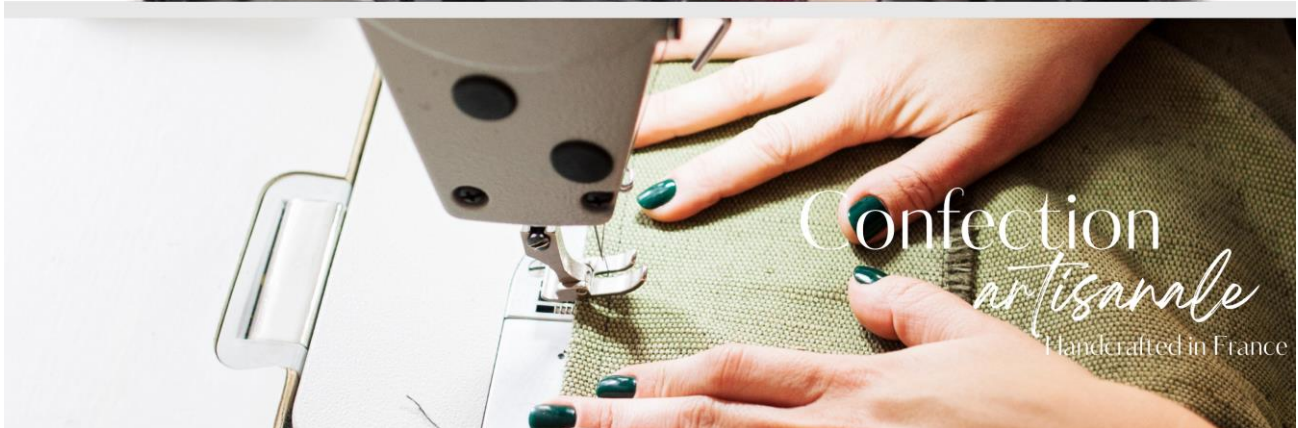

Confection

artisanale

Handcrafted in France

04

Gammes PVC

Sonoclean, Sonoskaï, Sonotan, Pampa

11

Sets - Duos - Tapis de table - Sets Enfants

Placemats - Duos - Table mats - Kids placemats

21

Panières - Panières Buffet - Fonds de panières

Baskets - Buffet baskets - Basket bottom

35

Accessoires de table

Table accessories

45

Personnalisation

Customisation

47

Nappage - Protège-table - Juponnage

Tablecloths - Table protector - Skirting

65

Serviettes - Liteaux - Maniques - Bavoirs

Napkins - Bottle napkins - Potholder - Bibs

75

Ameublement Textile

Textile furnishing

86

Housses & galettes de chaise

Chair cover

89

Tabliers

Aprons

SOMMAIRE

Les matières PVC

Pour sets, panières, accessoires de table / For placemats, baskets, table accessories



Tiss Terracotta (TITR)



Tiss Beige (TIBG)



Tiss Azur (TIAZ)



Transat (TRAN)



Tiss Taupe (TITP)



Tiss Chocolat (TICC)



Tiss Saugé (TISG)



Tiss Moutarde (TIMT)



Rayé (RAYU)



Tiss Blanc (TIBC)



Tiss Gris (TIGR)



Tiss Acier (TIAC)

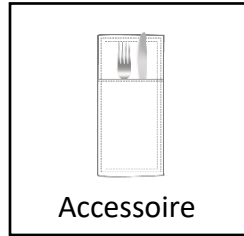
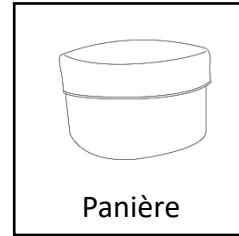
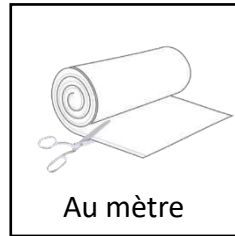
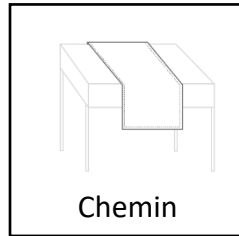
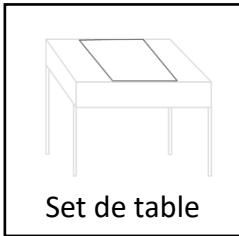
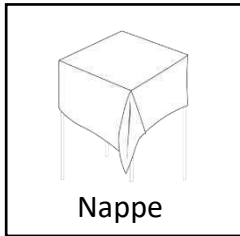

Carreaux Noir (CANR)



Interior Gris (INGR)



Carreaux Rouge (CARG)



Interior Rouge (INRG)



Osier Acier-Blanc (OS-ACBC)



Osier Camel-Vanille (OS-CMVN)



Tiss Noir (TINR)

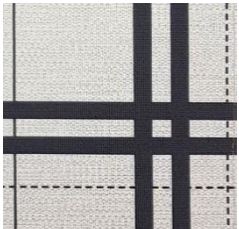

Torchon Noir (TCNR)



Tiss Rouge (TIRG)

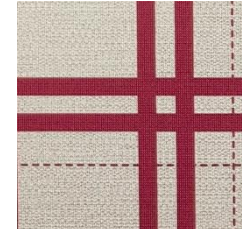

Torchon Rouge (TCRG)



Osier Acier (OSAC)



Osier Camel (OSCM)

Gamme SONOCLEAN

- 100% PVC effet tissu ou cuir
- Lavable à l'éponge
- Largeur 140 cm - 550gr/m2
- Lavable en machine à laver 30°C
- Imperméable
- Sans repassage

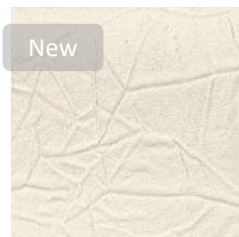

Kraft Blanc (KRBC)



Vintage Grège (VIGG)



Vintage Camel (VICM)



Vintage Cacao (VICC)



Vintage Ardoise (VIAR)



Cottage Beige (COBG)



Kraft Naturel (KRNT)



Paillette Or (PLOR)



Paillette Argent (PLAG)



Paillette Bronze (PLBZ)



Western Vanille (WEVN)

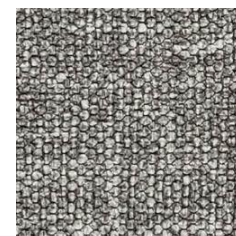

Cottage Gris (COGR)



Rotin (ROTI)



Jean Beige (JEBG)

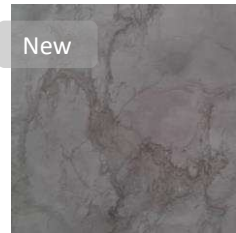

Stone Gris (STGR)

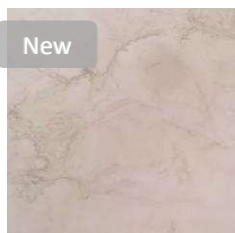

Stone Beige (STBG)



Vache (VACH)

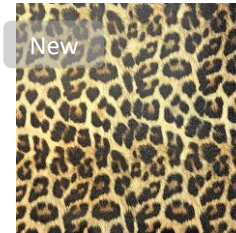

Leopard (LEOP)

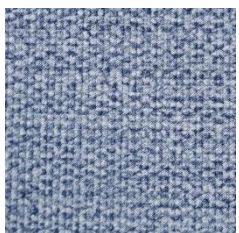

Jean Bleu (JEBL)

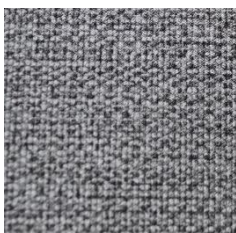

Jean Gris (JEGR)



Liège Bouchon (LGBC)



Crin Noir (CRNR)



Jean Blanc (JEBC)



Interior Bleu (INBL)

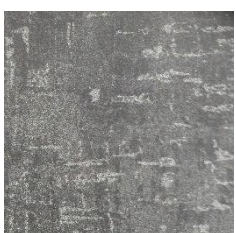

Liège Carbone (LGCB)



Crin Taupe (CRTP)



ON ADORE:

- ✓ Réutilisable
- ✓ Vrai effet tissu ou cuir
- ✓ Utilisation intérieur/extérieur (terrasse ombragée)

Les matières PVC

Pour sets, panières, accessoires de table / For placemats, baskets, table accessories

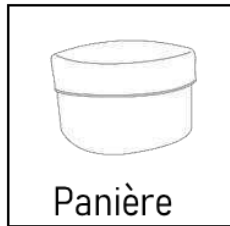
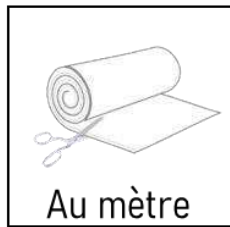
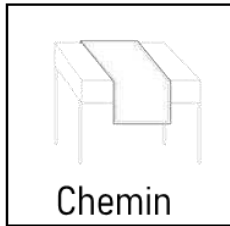
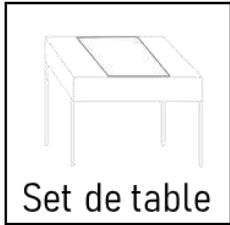
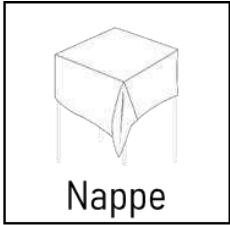

Gamme SONOSKAÏ

- 100% PVC effet cuir grainé
- Largeur 140 cm - 400gr/m²
- Lavable à l'éponge
- Lavable en machine à laver 30°C (1 à 2 fois par mois)
- Imperméable
- Sans repassage



Noir (SINR)



Souris (SISR)

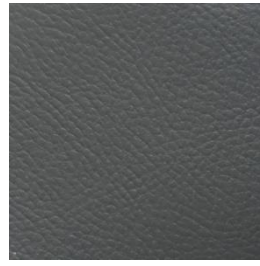

Ardoise (SIAR)



Daim (SIDM)



Rouge (SIRG)

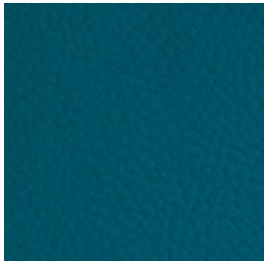

Paon (SIPN)



Bordeaux (SIBX)



Kaki (SIKK)



Curcuma (SICR)



Gold (SIGD)



New

Brume (SIBM)



New

Brique (SIBQ)



Taupe (SITP)



New

Mastic (SIMA)

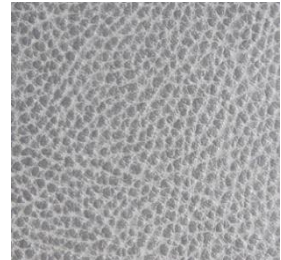

Argent (SIAG)



New

Copper (SICO)



ON ADORE:

- ✓ VEGAN et réutilisable
- ✓ Effet cuir grainé
- ✓ Désinfection facile et rapide
- ✓ Utilisation intérieur et extérieur (terrasse ombragée)

*VEGAN and reusable
Grained leather effect
Quick and easy to disinfect
Indoor and outdoor use (shaded terrace)*

Gamme SONOTAN

- Cuir synthétique / *Synthetic leather*: 86% PVC - 12% Polyester - 2% Polyurethane
- Largeur / *Width*: 140 cm - Poids / *Weight*: 950gr/m²
- Pour sets, panières, accessoires de table / *For placemats, baskets, table accessories*



Camel (TACM)



Marine / Navy (TAMN)



Rouge / Red (TARG)



Argent / Silver (TAAG)

ON ADORE:

- | | |
|---------------------------------|---------------------------------------|
| ✓ VEGAN et réutilisable | ✓ <i>VEGAN and reusable</i> |
| ✓ Effet vrai cuir épais | ✓ <i>Thick genuine leather effect</i> |
| ✓ Imperméable | ✓ <i>Waterproof</i> |
| ✓ Antidérapant | ✓ <i>Non-slip</i> |
| ✓ Lavable à l'éponge | ✓ <i>Sponge-washable</i> |
| ✓ Machine à laver à 30°C | ✓ <i>Machine washable at 30°C</i> |



Noir / Black (TANR)

Découpe laser sur-mesure
Finition de haute qualité
Surpiqûre au fil épais

Custom laser-cutting
High-quality finishing
Thick thread topstitching

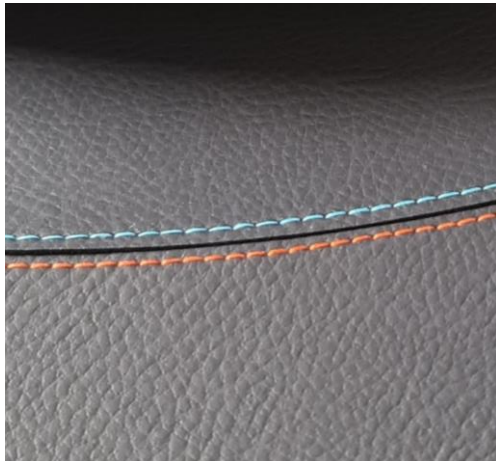

Surpiqûre de couleur possible.
Colored stitching available.



Matière idéale pour la gravure laser
Ideal material for laser engraving



Option poinçon (en supplément)
Punch option (extra charge)

Gamme *Pampa*

COLORIS



Ecreu



Paille



Chocolat



Gris

Idéal pour paniers et sets de table
Ideal for baskets and placemats

- 100% Polypropylène effet paille tressée
Polypropylene braided straw effect.
- Lavable à 40°C, Essorage 800T/mn
Retrait +/- 4% après 1er lavage

*Washable at 40°C, Spin 800 rpm
Shrink +/- 4% after 1st wash*

- Résistant & réutilisable
Strong & reusable



Sets, Duos, Tapis *1 face ou 2 faces*

Placemats, Duos, Table mats



Les sets

Placemats

Les formes
The shapes

p. 12

Collection Insolites
Unusual placemats

p. 14

Collection Enfant
Kids' placemats

p. 15

Sets double-utilisation
Double-use placemats

p. 16

Collection Pochoirs

p. 19



Les formes de SET DE TABLE (toutes tailles et toutes formes, découpes spéciales sur devis)



Placemats shapes

1 face ou 2 faces, coloris au choix: gammes Sonoclean, Sonoskaï, Sonotan

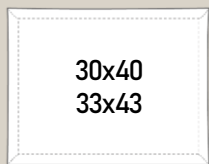

Rectangle



Rond

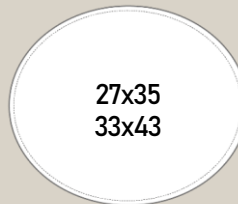

Ovale

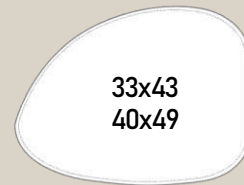

Ovoïde

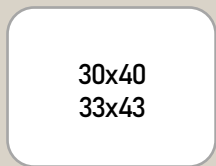

Coins arrondis



Carré

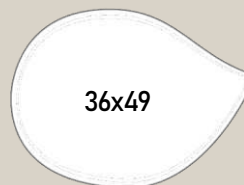

Goutte



Galet



Tâche

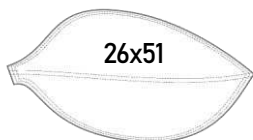

Feuille



Tanneur



Coeur

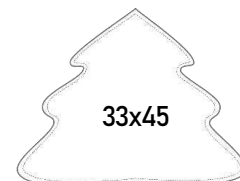

Sapin

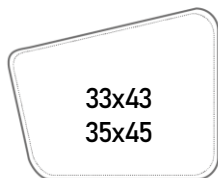

Asymmetric

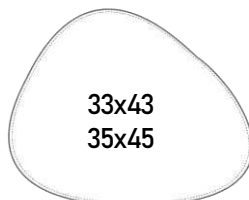

Triangle

New

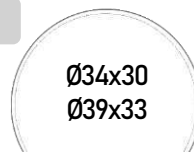

Sphere

New

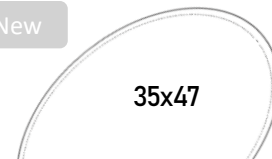

Oblong

New



Trapèze



Diamant

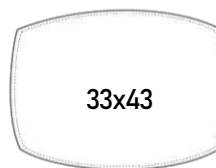

Ecran

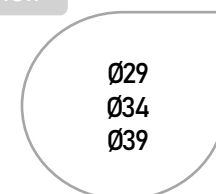

Quart



Sets Placemats

PERSONNALISABLES
CUSTOMIZABLE

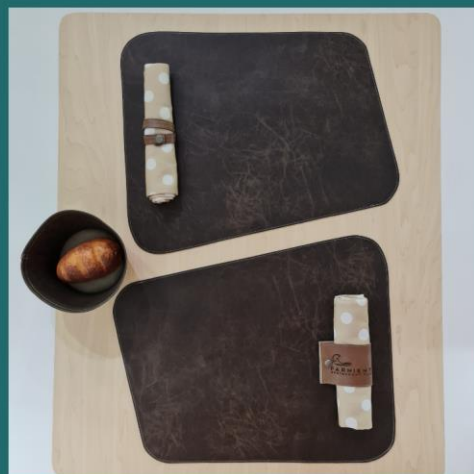

Collection Insolite

Sets de table



Cerf - l:46 x H:33cm



Vache- 38x38cm



Buffle - l:45 x H:33cm

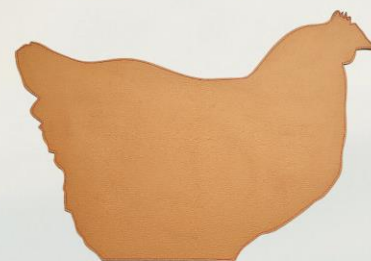

Poule - l:48 x H:33cm

PVC imperméable / Waterproof
Lavable à l'éponge et machine 40°C
Sponge-wash and washing machine

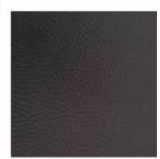

Sonotan Noir



Sonotan Camel



Sonotan Rouge



Sonotan Marine



Sonotan Argent



Bulle - l:45 x H:33cm



Némo - l:50 x H:25cm



Set de table

Enfant



Kids placemats

Coloris/Colors: SONOCLEAN, SONOSKAI, SONOTAN

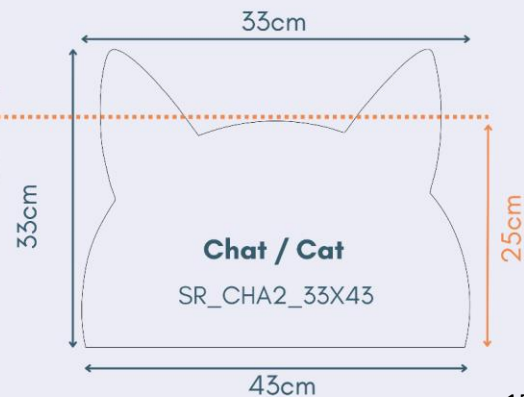
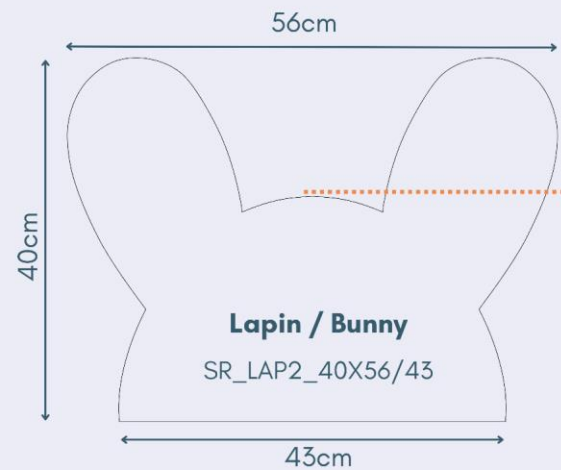

Combinaisons Matières/Finitions

Material/Finish combinations

Set / Placemat Finition / Finish	1 face Tarif A	1 face Tarif B	2 faces réversible Tarif C	2 faces réversible Tarif D
Coupe Laser <i>Laser cut</i>		SONOTAN	SONOCLEAN/SONOCLEAN SONOCLEAN/SONOSKAÏ SONOSKAÏ/SONOSKAÏ	SONOTAN / SONOTAN
Surpiqûre <i>Topstitching</i>		SONOTAN	SONOCLEAN/SONOCLEAN SONOCLEAN/SONOSKAÏ SONOSKAÏ/SONOSKAÏ	SONOTAN/SONOTAN SONOTAN/SONOSKAÏ SONOTAN/SONOCLEAN
Ourlet ou bourdon <i>Hem or bourdon stitch</i>	MATIERE TEXTILE JUTE SONOCLEAN SONOSKAÏ	SONOSUN PAMPA		SONOTAN / JUTE SONOTAN / MATIERE TEXTILE SONOTAN / PAMPA

Sets double utilisation

1 face ou 2 faces, coloris au choix: gammes Sonoclean , Sonoskaï, Sonotan

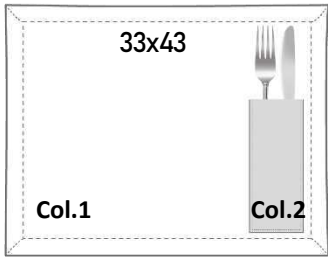

À poche

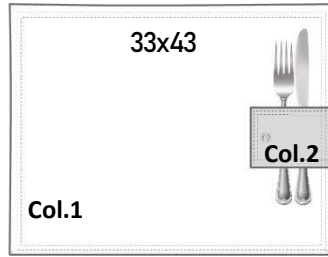

À languette

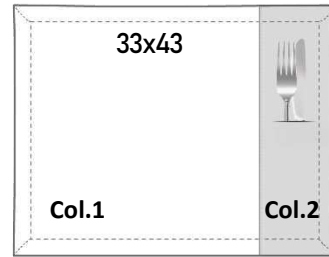

Etui

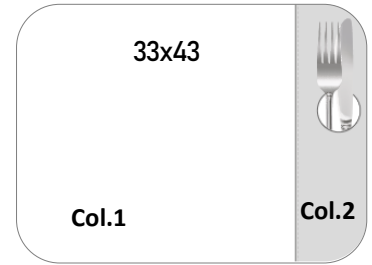

Hublot

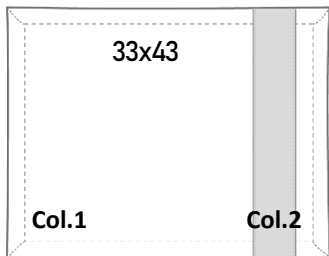

Bandeau

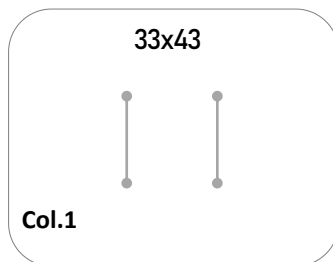

Accueil

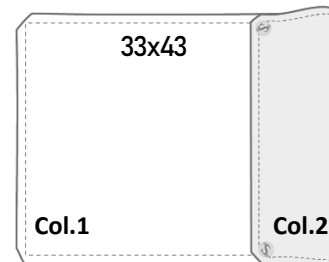

À soufflet

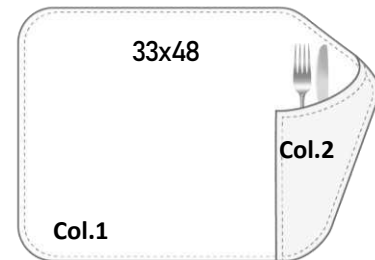

Cornet



Sets double
utilisation
Double use
placemats
PERSONNALISABLES
CUSTOMIZABLE

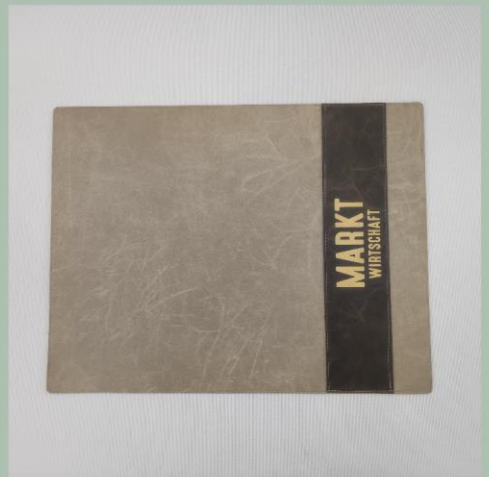

Set de table *Accueil*

Fentes ou bandeau à réaliser sur toute forme de set.
Slots or headband to be made on any shape of placemat.



Personnalisation gravure laser
Laser engraving customization

Collection Pochoirs

Paniers, sets, porte-couverts



Panière Pot Carré
10x10x11cm



Set coins arrondis
33x43cm

- Découpe de formes à la machine laser
- Coloris au choix: voir gammes Sonoclean, Sonoskaï, Sonotan



Cœur Rouge



Sapin Rouge



Etoile Rouge



Cœur Camel



Sapin Camel



Etoile Camel



Porte-couverts
10x24cm

Mix & Match *au gré de vos envies*



Les panières

Baskets

Les formes
The shapes

p. 22-25

Panière Brot

p. 26

Collection Jute

p. 27

Panière Buffet-Pampa

p. 28

Collection Jersey

p. 29

Collection Peluche

p. 30

Collection Crin

p. 31

Panière Montagnarde

p. 32

Les fonds de panières
Basket bottoms

p. 33



Les formes de Pannières

Basket shapes

à réaliser dans les matières PVC: Sonoclean, Sonoskaï, Sonotan, Sonosun, Pampa
Et les gammes TEXTILE: Sonojean, Jute, etc.

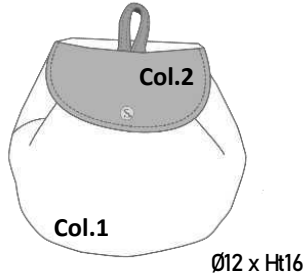

Borsalino

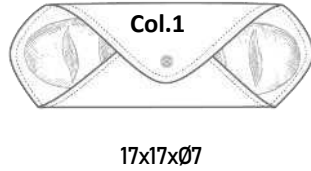

Baguettine

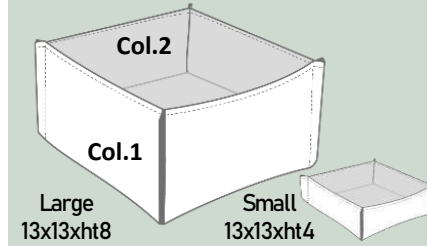

Barket

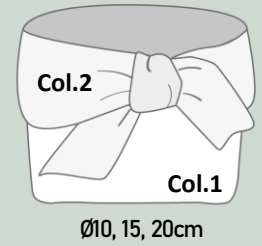

Nœud

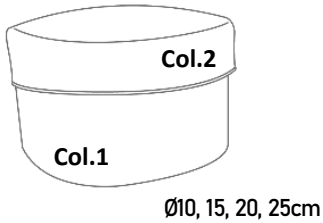

Ronde

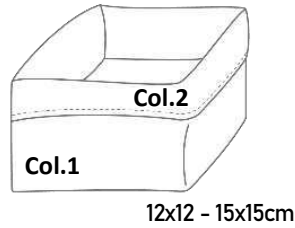

Carrée

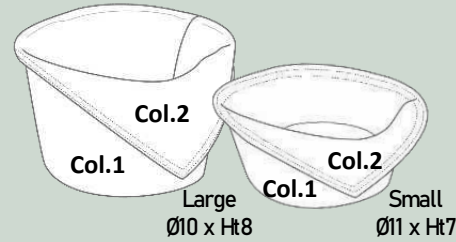

Bandana

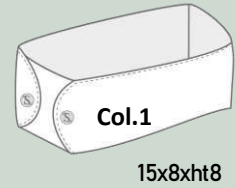

Oslo

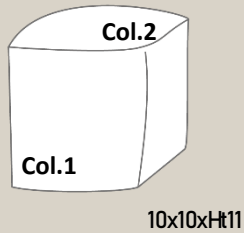

Pot carré

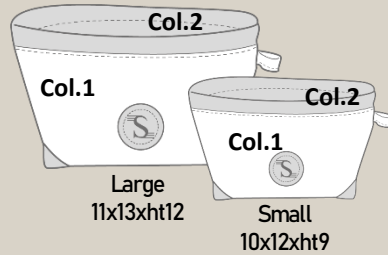

Ecrin

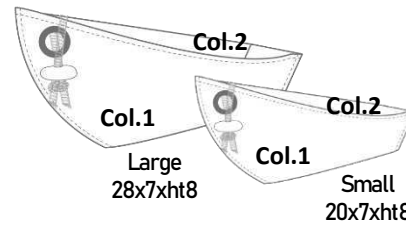

Bateau

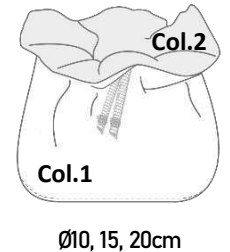

Bonbon

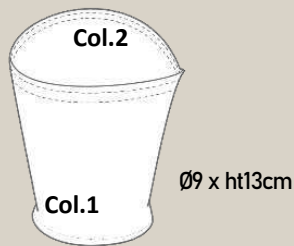

Cornet

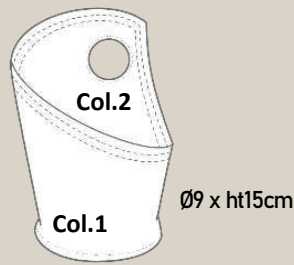

Hublot

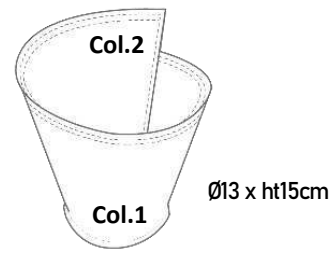

Biseau

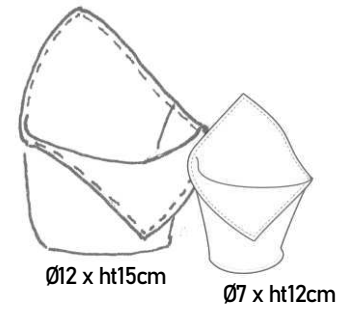

Bicorne Domette

Les Pannières



Borsalino



Baguettine



Barket (Grand, Petit)



Nœud



Ronde (Ø10, 15, 20, 25cm)



Carrée (12x12, 15x15cm)



Bandana (Grand, Petit)



Oslo



Pot carré



Ecrin



Bateau (Grand, Petit)



Bonbon



Cornet



Hublot



Biseau



Bicorne

Dosette

Les formes de Panières

à réaliser dans les matières PVC: Sonoclean, Sonoskaï, Sonotan, Sonosun, Pampa
Et les gammes TEXTILE: Sonojean, Jute, etc.

Basket shapes

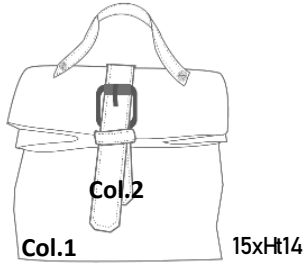

Sacoche

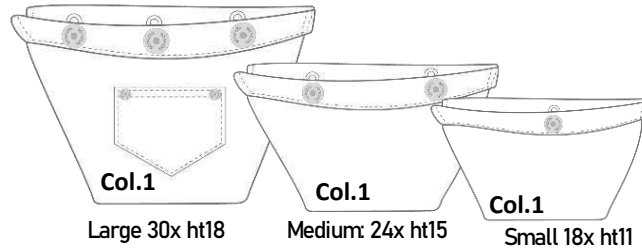

Trousse (Grand, Moyen, Petit)

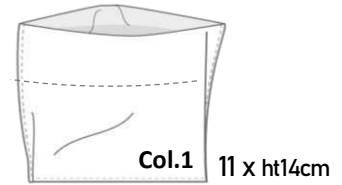

Faro

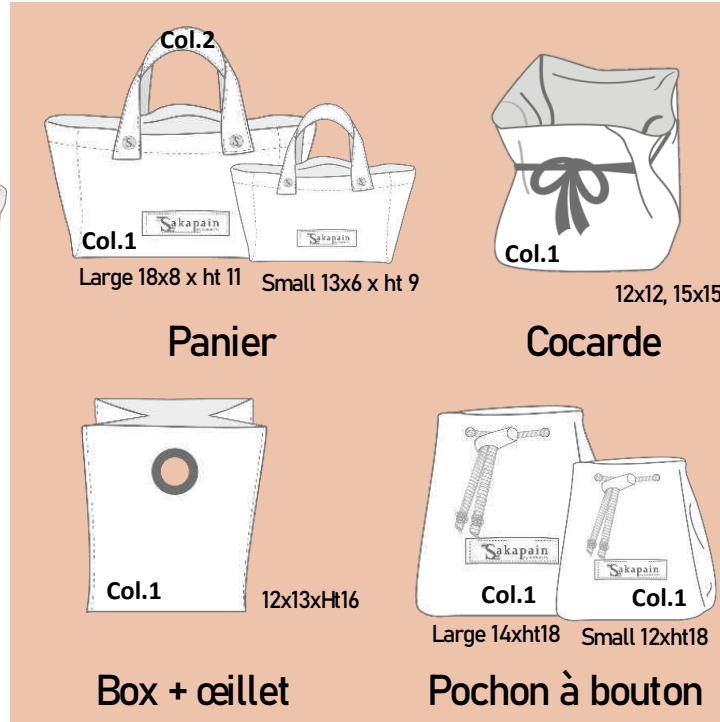
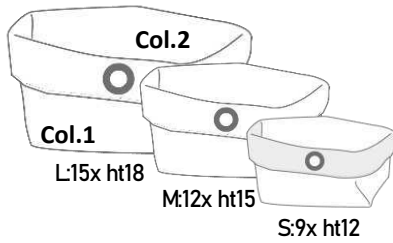

Panier

Cocarde

Box + œillet

Pochon à bouton

À œillet 1 ou 2 couleurs

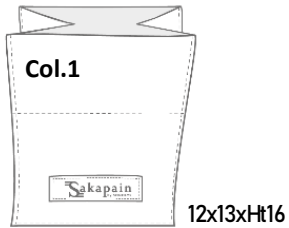

Box + étiquette

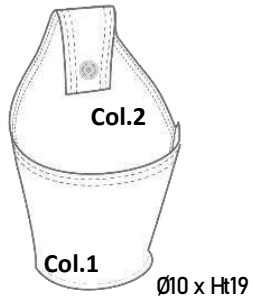

Seau

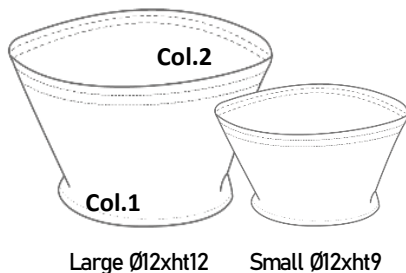

Coupelle

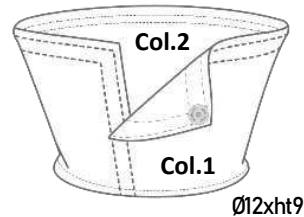

Soucoupe

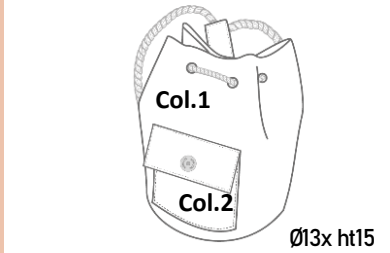

Sakado

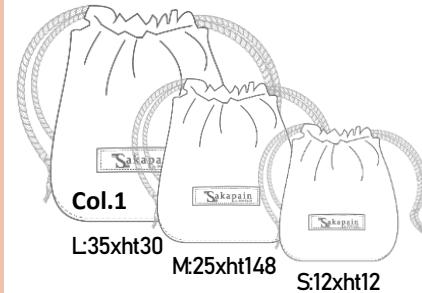

Pochon à lacets

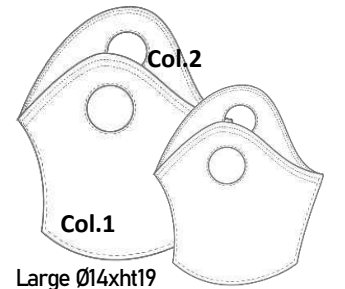

Bag

Les Pannières



Sacoche



Trousse (Grand, Moyen, Petit)



Faro



À œillet (Grand, Moyen, Petit)



Panier (Grand, Petit)



Cocarde



Sakado



Box + étiquette



Box + œillet



Pochon à bouton



Pochon à lacets



Seau



Coupelle (Grand, Petit)



Soucoupe



Bag

Panière *Brot*



JUTE / SONOSKAÏ

Collection Jute



Panière Pochon Lacet Jute

- Petit : 12x18cm
- Moyen: 25x18cm

Jute / Torchon MIF



Jute / Bistro

Panière Pochon Lacet + Doublure

- Petit : 12x18cm
- Moyen: 25x18cm



Panière Pochon à bouton

- Petit : 12x13cm
- Moyen : 14x15cm



Panière Box+Etiquette

- Taille unique: 12x Ht 13cm



Grande Trousse Jute

- Grand : 30x18cm



Panière Trousse Jute ou Jute blanc

- Petit : 18x11cm
- Moyen: 24x15cm



Panier souple Jute

- Petit: 13x6x Ht 9cm
- Grand: 18x8x Ht 11cm



Panière Sakado

- TU: Ø13x Ht 15cm



Panière Faro

- TU: 11x Ht 14cm



Panier rigide Jute/Sonotan

- Petit: 13x6x Ht 9cm
- Grand: 18x8x Ht 11cm



Panière Cornet

- TU: Ø9 x Ht 13cm



Panière Bicorne

- Petit: Ø12 x Ht 15cm



Panière Jute / Sodenim Moutarde

- Ø 10 / 15 / 20 / 25cm



Panière Jute / Sodenim Taupe

- Ø 10 / 15 / 20 / 25cm



Panière Jute / Sodenim Kaki

- Ø 10 / 15 / 20 / 25cm



Jute / Sodenim Noir

- Ø 10 / 15 / 20 / 25cm

Spécial Buffet / Gamme Pampa



Panière Faro 11x14cm
 Coloris: Pampa Ecrú
 Réf.: FAROP PAEC



Panière 11x14cm
 Coloris: Pampa Paille
 Réf.: FAROP PAPL



Panière 11x14cm
 Coloris: Pampa Chocolat
 Réf.: FAROP PACC



Panière Faro 11x14cm
 Coloris: Pampa Gris
 Réf.: FAROP PAGR



Panière Ronde Ø30cm
 Coloris: Pampa Gris
 Réf.: PSR D30 PAGR



Panière Ronde Ø25cm
 Coloris: Pampa Chocolat
 Réf.: PSR D25 PACC



Panière Ronde Ø20cm
 Coloris: Pampa Paille
 Réf.: PSR D20 PAPL



Panière Ronde Ø15cm
 Coloris: Pampa Ecrú
 Réf.: PSR D15 PAEC



Panière Bicorné Ø30cm
 Coloris: Pampa Ecrú
 Réf.: PSBI D30 PAEC



Panière Bicorné Ø10cm
 Coloris: Pampa Paille
 Réf.: PSBI D10 PAPL



Grand Panier 8x18x11cm
 Coloris: Pampa Paille
 Réf.: PNPA GRA PAPL



Petit Panier 6x13x9cm
 Coloris: Pampa Paille
 Réf.: PNPA PET PAPL



Buffet Baguette 24x24x35cm
 Coloris: Pampa écrú
 Réf.: PSBFBG 24X24X35 PAEC



Buffet Rectangle 25x35x15cm
 Coloris: Pampa Paille
 Réf.: PSBF 25X35X15 PAPL



Buffet Rectangle 15x25x15cm
 Coloris: Pampa écrú
 Réf.: PSBF 15X25X15 PAEC



Buffet Carré 20x20x15cm
 Coloris: Pampa Paille
 PSBF 20X20X15 PAPL

Collection Jersey

Paniers et porte-couverts



Cornet Jersey Gris /
Sonotan Camel



Cornet Jersey Kaki /
Sonotan Camel



Cornet Jersey Noir /
Sonotan Camel



Cornet Jersey Beige /
Sonotan Camel



Cornet Jersey Moutarde /
Sonotan Camel



Coupelle Jersey Gris /
Sonotan Camel



Coupelle Jersey Kaki /
Sonotan Camel



Coupelle Jersey Noir /
Sonotan Camel



Coupelle Jersey Beige /
Sonotan Camel



Kaki



Gris



Moutarde



Beige



Noir

Etiquette personnalisable



Paniers



Panière rectangulaire



Porte-couverts

Collection Peluche

Paniers et porte-couverts



Poil Brun



Poil Blanc



Mouton
Crème

Extérieur = Fourrure synthétique

Intérieur = PVC effet cuir, imperméable

Panière lavable à l'éponge.

*Exterior = synthetic fur
Inside = PVC fabric effect, waterproof*

Sponge-washable basket



Cornet Mouton Crème /
Sonotan Camel



Panier Mouton Crème /
Sonotan Camel



Coupelle Poil Brun /
Sonotan Camel



Panier Poil Brun /
Sonotan Camel



Porte-couverts
Poil Brun



Porte-couverts
Poil Blanc



Coupelle Poil Blanc /
Sonotan Camel



Cornet Poil Blanc /
Sonotan Camel



Panier Poil Blanc /
Sonotan Camel

Collection Crin

Sets, panières, accessoires



Crin Noir



Crin Taupe



Pampa Choco



Pampa Gris



Panière Ø15cm
Pampa Gris / Crin Noir



Panière Ø15cm
Pampa Choco / Crin Taupe

Produits imperméables (Sonoclean/Pampa)
Lavable à l'éponge

Waterproof products (Sonoclean /Pampa)
Sponge-washable

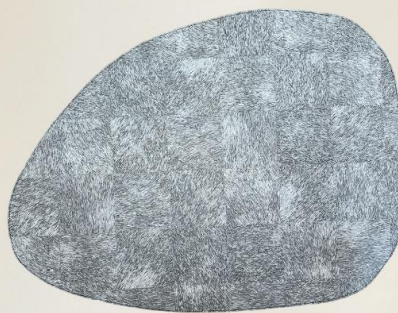

Set Ovoïde 2 faces 33x43
Crin Noir



Set Ovoïde 2 faces 33x43
Crin Taupe



Porte-couverts
Pampa Gris / Crin Noir



Porte-couverts
Pampa Choco / Crin Beige



Sous-verre



Etui à couverts



Panière Montagnarde

Croustons et pommes de terre



Jute / Tiss Saugé (Sage)



Jute / Tiss Beige



Jute / Tiss Terracotta



Jute / Tiss Chocolat



Jute / Tiss Azur



Jute / Tiss Noir (Black)



Jute / Vache (Cow)



Jute / Tiss Blanc (White)



Jute / Tiss Taupe

Idéale pour les plats montagnards:
à remplir avec des croustons
de pains ou pommes de terre

Ø 15cm = 2 personnes
Ø 20cm = 4 personnes
Ø 25cm = 6 personnes

Extérieur = Jute naturelle
Intérieur = PVC effet tissu, imperméable
Noeud décoratif = polycoton
Autres coloris: Sonoclean ou Sonoskaï.

Panière lavable à l'éponge.

*Exterior = natural jute
Inside = PVC fabric effect, waterproof
Decorative bow = polycotton
Other colors: Sonoclean or Sonoskaï.*

Sponge-washable basket



100% Polyester:
LINELYS ou MAGILYS

Anti-miettes
Holds bread crumbs

Lavable à 30°C, 800T/mn
Sans repassage

40x40cm

35x35cm

Fonds *de paniers*



Carreau Rouge Carreau Noir Mosaïque Jaune



Damier Vert Damier Jaune Damier Gris Damier Rouge



Rayures Marine Romane Etoile



Linélys Vanille Fleurette Coco Beige



Palmier gris Uni Thym Exotic



Liberty Girafon Aubépine



Bambou Linélys Beige Palmier Beige



Pâquerette Uni Brique Big Night

Accessoires de table

à réaliser dans les matières PVC: Sonoclean, Sonoskaï, Sonotan, Sonosun, Pampa
Et les gammes TEXTILE: Sonojean, Jute, etc.

Sous-verre

1 face

Ou 2 faces (réversible)



Rond



Carré



Tâche



Triangle



Duo

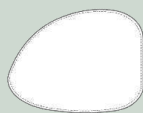

Ovoïde



Goutte

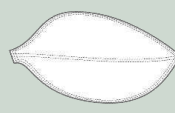

Feuille



Galet

Porte-menu



A pression



A élastique

Roll



N° de table

Chevalet



Porte-clé



N° de table

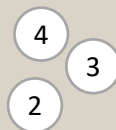

Mousqueton



Porte-couverts



Cornet

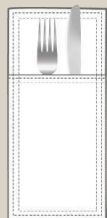

Classique



Etui



Roll

Porte-addition



Pochette



Roll



Portefeuille

Rond de serviette



Bague



Manchette



Losange

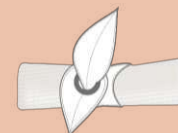

Feuille



Pince



Ceinture



Spiral



Croisé

Les accessoires

Table accessories

Sous-verre
Coaster

p. 36

Rond de serviette
Napkin ring

p. 37

Porte-addition
Bill holder

p. 38

Porte-couverts
Cutlery holder

p. 39

Porte-lame
Knife holder

p. 40

Porte-menu
Menu holder

p. 41

N° de table & porte-clé
Table number & key ring

p. 43





Sous-verre *sous-boc*

Au choix / *Your choice:*
1 face ou 2 faces

Coloris / *Colors:*

- Sonoclean
- Sonoskai
- Sonotan
- Jute

Lavable à l'éponge
Sponge washable



Ø11

Rond
Round



11x11

Carré
Square



10x10

Coins arrondis
Rounded corner



20x11

Oblong



20x11

Duo

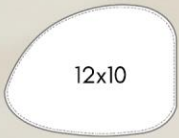

12x10

Ovoïde



12x10

Triangle

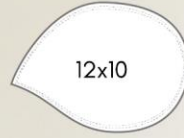

12x10

Goutte
Drop

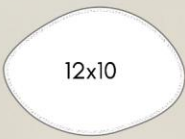

12x10

Galet
Pebble

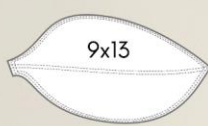

9x13

Feuille
Leaf



Ø12

Tâche
Stain

Ajoutez votre logo
Add your logo





Ronds *de serviettes*

Coloris / Colors:

- Sonoclean
- Sonoskaï
- Sonotan
- Jute
- Sonostyle
- Sonojean

Lavable à l'éponge
Sponge washable



Bague



Feuille



Losange



Croisé

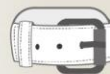

Ceinture



Spiral

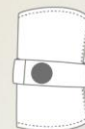

Manchette

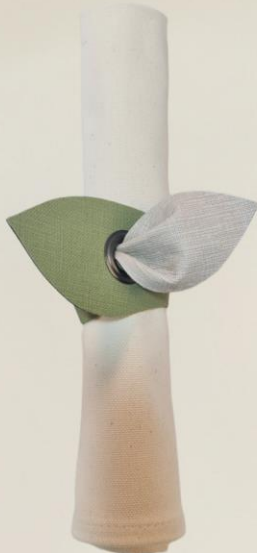



Au choix / Your choice:
Unicolore ou bicolore

- Coloris / Colors:
- Sonoclean
 - Sonoskaï
 - Sonotan
 - Jute

Lavable à l'éponge
Sponge washable

Tous nos produits sont personnalisables



Ronde
Ø8 x Ht 6cm



Assiette
Ø12 x Ht 3cm



Corneto
Ø11 x Ht 10/6cm



Pot
Ø10 x Ht 8cm



Pointes
Ø7 x Ht 12cm



Dosette
Ø7 x Ht 12cm



Livret
15 x 8cm (fermé)
15 x 16cm (ouvert)



Roll
Ø6 x ht 18cm (fermé)
18 x 25cm (ouvert)



Portefeuille
1.8 x L. 15cm (fermé)
1.15 x L. 25cm (ouvert)



Pochette
1.10 x L. 15cm

Porte-couverts *Etui, pochette*



Au choix / *Your choice:*
Unicolore ou bicolore

Coloris / *Colors:*

- Sonoclean
- Sonoskai
- Sonotan
- Jute

Lavable à l'éponge
Sponge washable



Classique



Cornet



Enveloppe à
pression



Set à couverts



Pochette à
baguettes



Roll à couverts



Etui à couverts





Porte-lame *de couteaux*

Au choix / *Your choice:*
Unicolore ou bicolore

- Coloris / *Colors:*
- Sonoclean
 - Sonoskaï
 - Sonotan

100% PVC, similicuir
Synthetic leather

Lavable à l'éponge
Sponge washable



Sonotan Noir



Sonotan Rouge



Sonotan Marine



Sonotan Camel



Sonotan Argent

Taille 1
Size



Confection sur-mesure
Made-to-measure

Taille 2
Size



Au choix / Your choice:
Unicolore ou bicolore

Coloris / Colors:

- Sonoclean
- Sonoskaï
- Sonotan

100% PVC, similicuir
Synthetic leather

Lavable à l'éponge
Sponge washable

Porte- menu

BRASSERIE
DUFOUR
Cuisine française

A4

A5



Option:
Languette

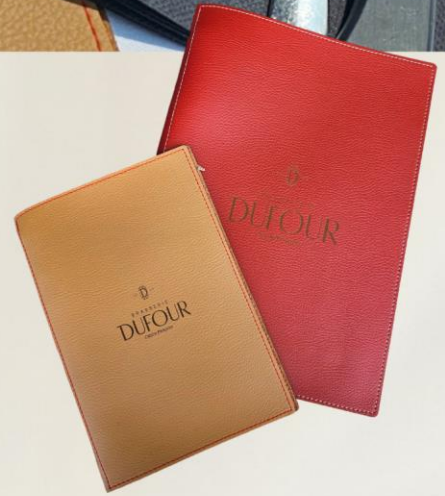

Modèle Pressions



Option logo:
gravure laser ou
sérigraphie couleur

Modèle Elastiqué



Pochettes
plastifiées à insérer
(non fournies)



Modèle Patte à vis



N° de table
personnalisable



N° de table
Ø6cm
Découpe laser



N° de table et porte-clés

Coloris / Colors:

- Sonoclean
- Sonoskai
- Sonotan
- Jute
- Sonojean
- Sodenim



Porte-clés:



Cœur



Poisson



Pochon



Label



Pyramide



Sac



Coussin
Gamme Linélys



Chevalet

Option:
Anneau brisé ou mousqueton:



Porte-clés
Rond Ø7cm

Exemples de personnalisation *Examples of customization*

Réalisation de « Bon à tirer » à valider avant mise en production (logo vectorisé à fournir par le client)
Creation of printproof to be validated before going into production (vectorized logo to be supplied by customer)

B.A.T. MURTOLI
- 10/03/23 -

DOMAINE DE MURTOLI



Panier en Jute

Sangles SONOTAN CAMEL
Sans surpiqûre

Étiquette ronde SONOTAN CAMEL Ø5cm
Surpiqûre beige
Logo gravure laser au centre



Étiquette Ø5cm

B.A.T. L'ANVIE
- 06/03/23 -

55 x set Triangle surpiqûre inversée

- Gravure laser
- Logo largeur 8cm
- En bas à gauche suivant la courbe, côté STONE ARDOISE

Page 1/2

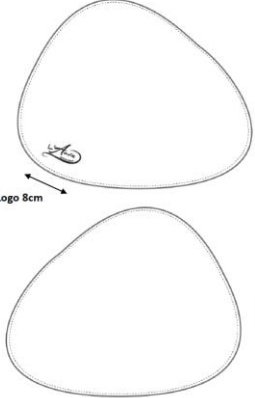

Logo 8cm

RECTO: STONE ARDOISE / Logo gravé
Surpiqûre Terracotta



VERSO: TISS TERRACOTTA / Pas de logo
Surpiqûre Ardoise



BEEFØR
BUTCHERS & CHEFS

15 x Tablier GED



Haut + poche latérale + sangles
Sonomixt Noir

Bas sonoskaï bordeaux



Logo sérigraphie 1 couleur

- Centré à gauche dessus la poche
- Couleur NOIR
- 8cm de large

B.A.T. L'ANVIE
- 06/03/23 -

30 x porte-couverts Cornet

- Gravure laser
- Logo largeur 8cm
- En haut suivant la courbe, côté STONE ARDOISE

Page 2/2



Logo 8cm

Intérieur: TISS TERRACOTTA / Pas de logo
Surpiqûre Ardoise



Extérieur: STONE ARDOISE / Logo gravé
Surpiqûre Terracotta





La Perso
Customization

BRODERIE, LASER,
SÉRIGRAPHIE



Tapis de table *1 face ou 2 faces*



Les nappes

Tablecloths

Quel tissu choisir ?
Which fabric to choose?

p. 48

Les finitions
Tablecloth finishings

p. 49

Tissus Imperméables - PVC
Waterproof fabrics

p. 50

Tissus imprimables - polyester
Printable fabrics

p. 52

Tissus Atypiques - polyester
Atypical fabrics

p. 56

Tissus Basiques - polycoton
Basic fabrics

p. 58

Tissus Naturels - coton ou lin
Natural fabrics

p. 60

Protège-table & Juponnage
Table protectors & table skirts

p. 62-63



LAVABLE À L'ÉPONGE

SPONGE WASHABLE



Les Imperméables

Waterproof fabrics

LAVABLE EN MACHINE

MACHINE WASHABLE

Sans
repassage

No ironing

Les Imprimables

Les Atypiques

Printables / Atypical

Avec
repassage

Ironing

Les Basiques

Les Naturels

Basics / Natural

Comment choisir
mes nappes ?

How do I choose my tablecloths?



8

Finitions

Finishings



Coupe laser
Laser cut



Surpiqûre
Topstitching

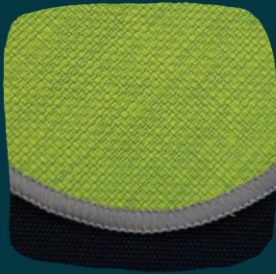

Bourdon
Bourdon stitch



Ourlet
Hem



Biais
Binding



Revers de
5, 10, 15 ou 20cm
Border



Coins Cravatte
Tie corner



Elastiqué
Elasticated

Les tissus imperméable (100% PVC effet tissu ou effet cuir)

Sonoclean



On adore:

- Imperméable
- Lavable à l'éponge
- Lavable machine 40°C



Caractéristiques:

100% PVC aspect tissu ou cuir
Largeur: 140cm
Poids: 550gr/m2

SANS REPASSAGE

Idéal pour:

Restaurants
Traiteur
Collectivités

48 coloris
(voir pages 3-4)

Sonoskaï



On adore:

- Imperméable
- Lavable à l'éponge
- Les coloris tendance
- Lavable machine 30°C



Caractéristiques:

100% PVC aspect cuir grainé
Largeur: 140cm
Poids: 400gr/m2

SANS REPASSAGE

Idéal pour:

Restaurants
Traiteur
Collectivités

16 coloris
(voir pages 5-6)

Sonotan



On adore:

- Imperméable
- Lavable à l'éponge
- Lavable machine 30°C
- Effet vrai cuir épais



Caractéristiques:

100% PVC aspect cuir épais
Largeur: 140cm
Poids: 950gr/m2

SANS REPASSAGE

Idéal pour:

Gastronomie
Set et tapis de table
(à la dimension du plateau de table)

5 coloris
(voir pages 7-8)

Sonosun

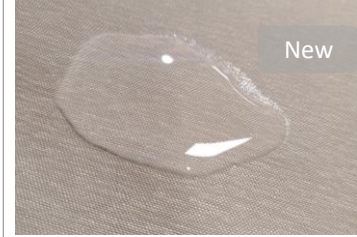

On adore:

- Imperméable
- Résiste aux UV et au sel
- Antibactérien
- Lavable à l'éponge
- Lavable machine 30°C



Caractéristiques:

80% PVC aspect tissu
20% Polyester
2% Polyuréthane
Largeur: 140cm
Poids: 620gr/m2

SANS REPASSAGE

Idéal pour:

Bord de plage / piscine
Terrasse





Ecrú



Taupe

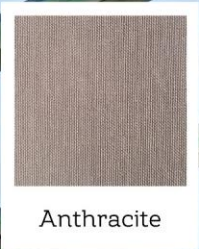

Anthracite



Gris

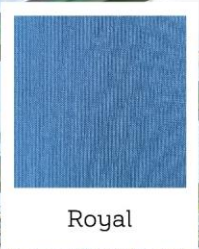

Roya

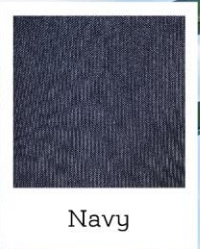

Navy



Jade

Gamme Zonosun

Résistant UV, pluie, huile, sel
Antibactérien, sans phtalate

UV, rain, oil, salt resistant
Antibacterial, phthalate free

98%% PVC 2% Polyuréthane

Largeur, width: 150cm
Poids, weight: 620gr/m²

Lavable à l'éponge
Sponge washable
Lavable à 30°C / 800T/mn
Washable at 30°C / 800 rpm

Spécial outdoor, résistant aux UV
Special outdoor, UV resistant, waterproof



Les tissus imprimables (100% polyester, sans repassage)

Linélys



On adore:

- Déperlant
- Effet lin naturel



Caractéristiques:

100% polyester **effet lin**
 Largeur: 145cm ou 300cm
 Poids: 220gr/m2
 SANS REPASSAGE

Blanc

Vanille

Beige

Idéal pour:

Restaurants
 Gastronomie
 Collectivités

(Coloris à imprimer sur fond blanc, vanille ou beige)

Tamilys



On adore:

- Effet coton
- Idéal pour serviettes



Caractéristiques:

100% polyester **effet coton**
 Largeur: 150cm
 Poids: 220gr/m2
 NON-FEU / SANS REPASSAGE

Idéal pour:

Restaurants
 Collectivités

Magilys

Déperlys Antiglys

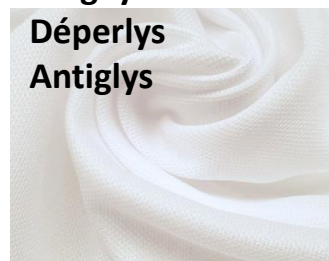

On adore:

- Léger, fluide
- Sèche en 10mn



Caractéristiques:

100% polyester **effet maille**
 Largeur: 150 et 175cm
 Poids: 220gr/m2
 SANS REPASSAGE

Idéal pour:

Bistrot
 Collectivités
 Traiteur
 Evènementiel
 Terrasse

Idéalys



On adore:

- Imperméable
- Lavable à l'éponge



Caractéristiques:

100% polyester **enduit**
 Largeur: 145cm
 Poids: 240gr/m2
 NON-FEU / SANS REPASSAGE

Idéal pour:

Bistrot
 Collectivités
 Terrasse

+ de dessins dans notre catalogue

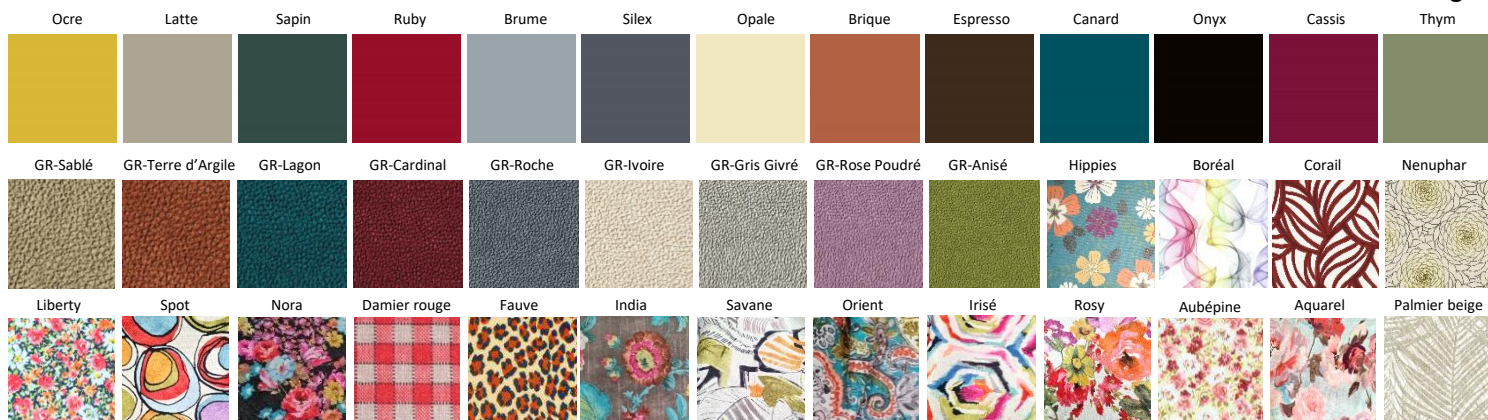



Pissenlit



Aquarelle



Lotus Jaune



Madras



Corail



Portail



Balnéo Rouge



Irisé



Nénuphar



Savane



Palmier Gris

Palmier Beige



Aérobic



Dentelle



Onde



Arc-en-ciel



India



Nora



Quadro



Marin



Boréal



Iris



Exotic



Spot



Rosy



Orient



Hippies



Aubépine



Kenzo Rose



Liberty



Eole Pierre



Sérénade



Saison

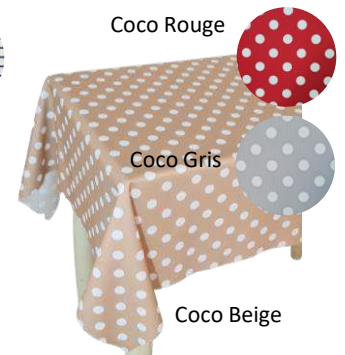
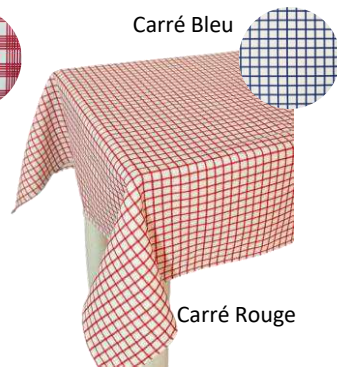
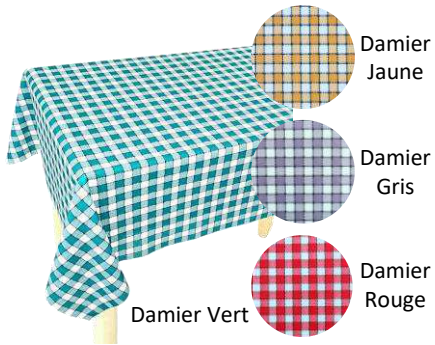

Les tissus Atypiques (100% polyester, sans repassage)

Velys



On adore:

- Style vintage, convivial
- Linge de table & tabliers



Caractéristiques:

100% polyester **velours côtelé**
 Largeur: 140cm
 Poids: 330gr/m2
 SANS REPASSAGE

Idéal pour:

Restaurants
 Gastronomie

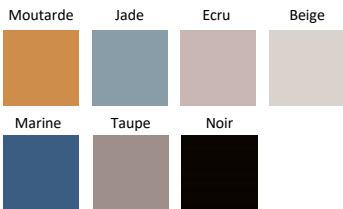

Sonostyle



On adore:

- Effet laine, style cosy
- Traitement déperlant



Caractéristiques:

100% polyester **effet laine**
 Largeur: 138cm
 Poids: 420gr/m2
 SANS REPASSAGE
 Traitement TEFLON

Idéal pour:

Restaurants
 Gastronomie



Cuirlys



On adore:

- Effet peau tannée, vieillie
- Doux au toucher



Caractéristiques:

100% polyester **aspect peau**
 Largeur: 140cm
 Poids: 235gr/m2
 SANS REPASSAGE

Idéal pour:

Bistros
 Restaurants



Facilys (outdoor)



On adore:

- Effet satiné, sobre, lumineux
- Résiste aux UV



Caractéristiques:

100% polyester **grande largeur**
 Largeur: 320cm
 Poids: 200gr/m2
 REPASSAGE FACILE
 Traitement TEFLON

Idéal pour:

Restaurants
 Gastronomie
 Terrasse
 Bord de mer / Piscine





Grand Carreau
Rouge



Grand Carreau
Beige



Petit Carreau
Beige



Petit Carreau
Rouge



Chevron Beige



Chevron Rouge



Chevron Gris



Chevron Taupe

Gamme *Sonostyle*

100% polyester effet laine
Wool effect polyester



Sans repassage, Teflon®
No ironing, Teflon treatment

Largeur, *width*: 138cm
Poids, *weight*: 420gr/m²

Lavable à 30°C / 800T/mn
Washable at 30°C / 800 rpm

Les tissus Basiques (Polycoton)

Sonochic



On adore:

- Traitement déperlant
- Tissu jacquard réversible



Caractéristiques:

75% polyester 25% coton
 Largeur: 280cm
 Poids: 230gr/m2
 SANS REPASSAGE
 Traitement TEFLON

Idéal pour:

Restaurants
 Gastronomie
 Collectivités

Trèfle Perle Mirage perle Canisse perle



Trèfle Ecu Mirage Ecu Canisse Ecu



Demilys



On adore:

- Doux au toucher
- Passe en calandre



Caractéristiques:

50% polyester 50% coton
Sobre et raffiné
 Largeur: 280cm
 Poids: 240gr/m2

Idéal pour:

Restaurants, Traiteur
 Gastronomie
 Serviettes de table

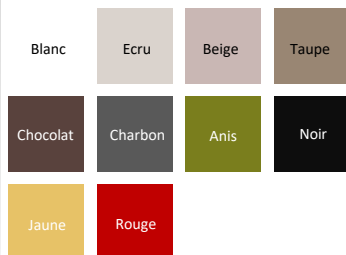

Sonomixt



On adore:

- Repassage superflux
- Grande largeur 280cm



Caractéristiques:

50% polyester 50% coton
Effet nid d'abeille
 Largeur: 280cm
 Poids: 225gr/m2

Idéal pour:

Bistrots, Restaurants
 Collectivités
 Serviettes de table



Sodenim

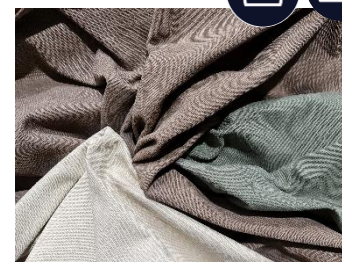

On adore:

- Style industriel / Casual
- Coton épais, délavé

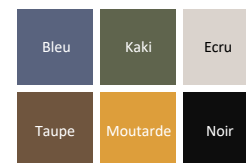

Caractéristiques:

80% coton 20% polyester
 Largeur: 150cm
 Poids: 470gr/m2

Idéal pour:

Restaurants / Gastronomie
 Panières / Tabliers

Sonojean

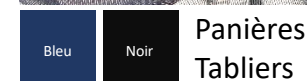

Gamme *Sonojean*



55% Coton
45% Polyester

Largeur/Width: 300cm
Poids/Weight: 280gr/m²

Sobre et raffiné
Sober and elegant

Lavable à 40°C - 800T/mn
Washable at 40°C - 800 rpm

Faible repassage
Light ironing



Bleu Foncé

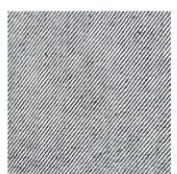

Bleu Clair



Noir

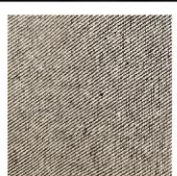

Gris

Bicolore réversible
Reversible 2 tones

Les tissus Naturels / Natural fabrics

Sonobio



On adore / We love:

- Issu d'agriculture bio
Organic product
- Naturellement moucheté
Naturally speckled



Caractéristiques:

100% Coton biologique
Organic cotton
Largeur/Width: 230cm
Poids/Weight: 285gr/m²

Idéal pour:

Restaurants
Gastronomie/*Gastronomy*

Coton naturel non traité

Purelys



On adore / We love:

- Sobre et raffiné
Sober and refined
- Grande largeur
Large width



Caractéristiques:

100% coton / *Cotton*
Largeur/Width : 280cm
Poids/Weight : 230gr/m²

Idéal pour:

Bistrot
Restaurants
Traiteur



Solin



On adore / We love:

- Lin froissé naturel
Natural creased linen
- Souple et doux
Flexible and soft



Caractéristiques:

100% lin / *Linen*
Largeur/Width : 280cm
Poids/Weight : 220gr/m²

Idéal pour:

Restaurants
Gastronomie



Nidelys

New



On adore / We love:

- Coton Nid d'abeille
"Honeycomb" cotton
- Repassage superflu
Light or no-ironing required



Caractéristiques:

100% coton
Largeur/Width : 150cm
Poids/Weight : 230gr/m²

Idéal pour:

Restaurants

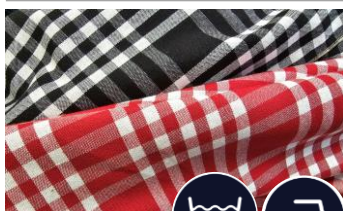

Bistrot

New

On adore / We love :

- Son style à la française
- Son côté convivial
- Repassage superflu



Caractéristiques:

100% coton
Largeur/Width : 180cm
Poids/Weight : 210gr/m²

Idéal pour:

Restaurants
Bistrot
Serviettes de table
Panières, Tabliers



Noir



Rouge

Gamme *Bistrot*

100% Coton

Largeur, width: 180cm

Poids, weight: 210 gr/m²

Lavage 40°C - 800T/mn

Retrait de 6%

Repassage non obligatoire
pour un effet gaufré naturel.



Rouge



Noir

Les protèges-table

Effet Bulgom



- Imperméable, Anti-bruit
- Antidérapant



Caractéristiques:

100% caoutchouc
Largeur: 138 cm
Poids: 650gr /m2

Lavable à l'éponge et machine
à 40°C (1 à 2 fois par an seulement).

Molleton envers PVC

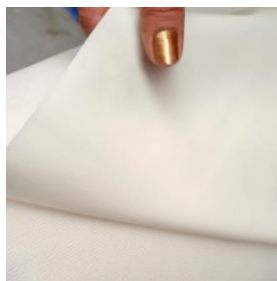

- Imperméable
- Anti-bruit



Caractéristiques:

100% Polyester envers PVC
Largeur: 200cm
Poids: 430gr/m2

Lavable à l'éponge et en machine à 40°C
Repassage possible sur le polyester.

Cristalys



- Imperméable
- Transparent



Caractéristiques:

100% PVC
Largeur: 135cm
Poids: 235gr/m2
Epaisseur: 0,2mm ou 0,8mm

Lavage à l'éponge uniquement.

Au choix:

Rouleau



Coupe sur-mesure

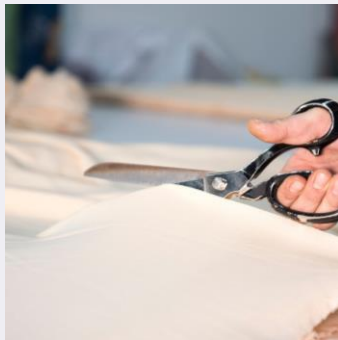

Housse élastiquée



Juponnage et housse de table

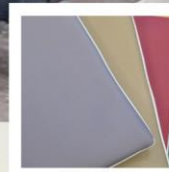

Magilys
Infroissable

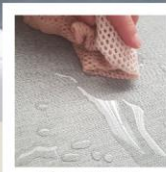

Sonoclean
Imperméable



Accroche Clip
ou Velcro

Fronces

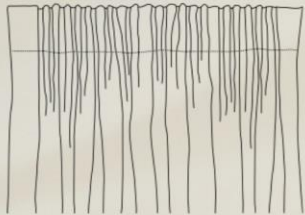

Pli simple

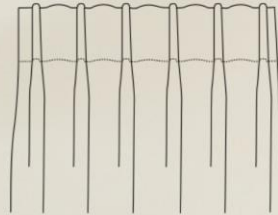

Pli inversé

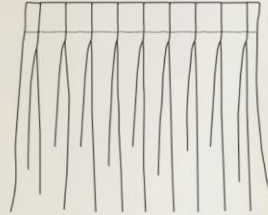

Sur-mesure ou par module de 4 mètres.

Couvercle



Conférence



Housse rectangle



Housse ronde



LAVAGE PAR PRESTATAIRE EXTÉRIEUR

EXTERNAL CLEANING SERVICE

DEMILYS	P.67
SONOMIXT	P.67
PURELYS	P.68
SONOTEX	P.68

LAVAGE PAR MES SOINS

WASHING BY MYSELF

Sans repassage No ironing		Avec repassage Ironing	
LINELYS	P.66	DEMILYS	P.67
TAMILYS	P.66	SONOTEX	P.68
SONOMIXT	P.67	PURELYS	P.68
BOHEME	P.69	SONOBIO	P.69
NIDELYS	P.69	SOLIN	P.60
BISTROT	P.60		

Comment choisir
mes serviettes ?

How do I choose my napkins?

Les serviettes

Napkins

Comment choisir mes serviettes ? p. 64
How do I choose my napkins ?

Serviettes polyester p. 66
Polyester napkins

Serviettes polycoton p. 67
Polycotton napkins

Serviettes coton p. 68-69
Cotton napkins

Serviettes à couverts p. 70
Cutlery napkins

Liteaux & Maniques p. 71
Bottle napkins & Potholder

Serviettes Invités & Bavoires p. 72-73
Guest Towel & Bibs



Serviettes Polyester



50x50cm

45x45cm

40x40cm

Option bicolore

LINÉLYS Polyester aspect lin
Linen effect polyester

TAMILYS Polyester aspect coton
Cotton effect polyester

Coloris de base



Coloris de base



Coloris à imprimer (unicolore ou bicolore)



100% Polyester

Largeur/Width: 150cm
Poids/Weight: 220gr/m²

Lavable à 40°C - 800T/mn
Washable at 40°C - 800 rpm

Sans repassage
No ironing

Sèche-linge interdit
Calandre interdit
Dryer prohibited



Serviettes fantaisies:
voir nos motifs

Serviettes *polycoton*



50% Coton
50% Polyester

Largeur/Width: 280cm
Poids/Weight: 240-225gr/m²

Lavage industriel autorisé
Industrial washing allowed

Lavable à 40°C - 800T/mn
Washable at 40°C - 800 rpm

Faible repassage
Light ironing

50x50cm

45x45cm

40x40cm

40x60cm

DEMILYS

SONOMIXT



Blanc



Ecrû



Beige



Taupe



Blanc crème



Noir



Gris



Beige



Chocolat



Charbon



Anis

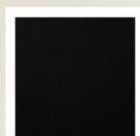

Noir



Chocolat



Taupe



Mauve

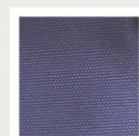

Bleu



Jaune

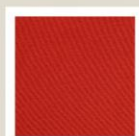

Rouge



Framboise



Jaune



Orange



Kaki



Rouge

Serviettes Coton



PURELYS

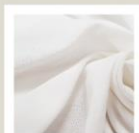

Blanc

100% Coton 230gr/m²

Dimensions:

- 50x50cm / par 4 pcs
- 45x45cm / par 5 pcs
- 40x40cm / par 5 pcs

Finition: 4 ourlets / 4 hems

Lavage industriel autorisé
Industrial washing allowed

Lavable à 40°C - 800T/mn
Washable at 40°C - 800 rpm

Repassage / Calandrage
Ironing / Calendering

50x50cm

45x45cm

40x40cm

SONOTEX



Blanc Jacquard



Blanc Lisse

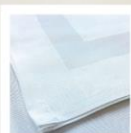

Bande Satin

100% Coton 220gr/m²

Dimensions :

- 50x50cm / par 1 pcs

Finition: 2 lisières / 2 ourlets
2 selvages / 2 hems

Lavage industriel autorisé
Industrial washing allowed

Lavable à 40°C - 800T/mn
Washable at 40°C - 800 rpm

Repassage / Calandrage
Ironing / Calendering

50x50cm

SONOBIO



Naturellement
moucheté

100% Coton 285gr/m²
issu d'agriculture bio non traité
Not treated organic cotton

Dimensions:

- 50x50cm / par 4 pcs
- 45x45cm / par 5 pcs
- 40x40cm / par 5 pcs

Finition: 4 ourlets / 4 hems

Lavable à 40°C - 800T/mn
Washable at 40°C - 800 rpm

Repassage / Calandrage
Ironing / Calendering

50x50cm

45x45cm

40x40cm

Serviettes 100% Coton



Lavable à 40°C - 800T/mn
Washable at 40°C - 800 rpm

Repassage superflu
Light or no-ironing required

45x45cm

40x40cm

30x30

Ideal serviettes invités
Perfect for guest towels

BOHÈME

Gaze de coton gaufrée - 130gr m²
Cotton gauze



Châtaigne (BHCT)



Raisin (BHRA)



Ciel (BHCL)



Ocre (BHOC)



Rouille (BHRL)



Kaki (BHKK)



Lilas (BHLL)



Beige (BHBG)



Blanc (BHBC)

NIDELYS

Coton "nid d'abeille" - 230gr m²
"Honeycomb" cotton



Châtaigne (NDCT)



Raisin (NDRA)



Ciel (NDCL)



Ocre (NDOC)



Rouille (NDRL)



Kaki (NDKK)



Lilas (NDLL)



Beige (NDBG)



Blanc (NDBC)

Serviette à couverts

Option logo:
gravure laser ou
sérigraphie couleur

50x50cm

45x45cm

40x40cm



Tissu au choix
(voir pages 64-69)

*Fabric of your choice
(see pages 64-69)*

Modèle Losange

Modèle à Pression



Modèle 1 Rabat



Liteau à enfiler

Personnalisable
Customizable



Manique doublée



Dimensions: 20x20cm
Épaisseur / Thickness: 5mm

50x50cm

45x45cm

40x40cm

40x60cm

Disponible en version classique sans œillet
Available in classic version without eyelet

DEMILYS

Polycoton sobre et raffiné
Sober, refined polycotton



Blanc



Ecriu



Beige



Taupe



Chocolat



Charbon



Anis



Noir



Jaune



Rouge



Framboise

SONOMIXT

Polycoton effet nid d'abeille
Polycotton honeycomb effect



Blanc crème

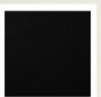

Noir



Gris



Beige



Chocolat



Taupe



Mauve



Bleu



Jaune



Orange



Kaki



Rouge

SONOJEAN

Polycoton style jean
Denim-effect polycotton



Bleu Foncé



Bleu Clair



Noir



Gris

Bavoirs Enfant

Serviette Invité

Elastique à enfiler



2ème âge: 38x30cm

100% Coton éponge bouclette

Largeur/Width: 148cm
Poids/Weight: 400gr/m²

Certification Oeko Tex
Standard 100 Classe 1

Lavable à 40°C - 800T/mn
Washable at 40°C - 800 rpm

Laver 3 fois séparément au début
Sèche-linge programme délicat
Non javellisable

*Wash 3 times separately first
Delicate program dryer
Non bleachable*

30x30cm - 30x50cm

Confectionné
en France

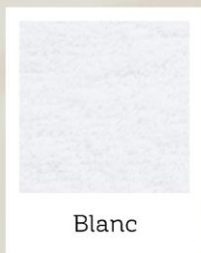

Bavoirs *Adulte*



Tissus & coloris
au choix:

Dimensions: 40x60cm
Idéal restaurants / collectivités

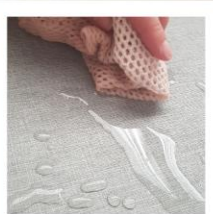

Sonoclean
Lavable éponge

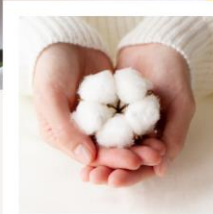

Demilys
Polycoton

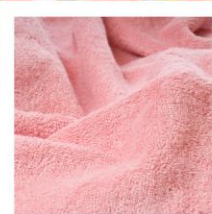

Eponge
Coton

A nouer



A pression



A oeillet



à personnaliser



Rideaux, coussins *chemin de lit*

Curtains, cushions, bed runners



L'Ameublement

Furnishings

Gamme SOVELVET
Velvet range

p. 77

Gamme BLACKLYS - occultant
Blackout range

p. 79

Tissus à motifs
Patterned fabrics

p. 80

Les confections
Types of garments

p. 81

Les embrasses
Tiebacks

p. 82

Les voilages
Veiling

p. 83

Coussins décoratifs
Decorative cushions

p. 84

Plaids - Gamme DOULYS
Plaids

p. 85





Gamme
Sovelvet

100% Velours polyester
Velvet polyester

Traitement non-feu
Flame retardant treatment

Lavable à 40°C
Washable at 40°C



NAPPE
TABLECLOTH

RIDEAUX
CURTAIN

COUSSINS
CUSHION

OUILLETS



Flore Ciel

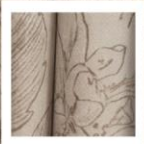

Flore Choco



Flore Rose

COLORIS



Rose



Olive



Chocolat



Ciel



Flore Olive

Gamme *Blacklys*

70% Polyester
30% Polyester recyclé

Largeur/Width: 280cm
Poids/Weight: 290gr/m²

Traitement non-feu
Flame retardant treatment

Lavable à 40°C - 800T/mn
Washable at 40°C - 800 rpm

Sans repassage
No need to iron

Occultant réversible: aspect lin & satin
Reversible blackout: linen & satin look

RIDEAUX
CURTAIN

CHEMIN LIT
BED RUNNER

COUSSIN
CUSHION

COLORIS



Taupe



Olive



Acier



Soleil



Ecru



Les tissus imprimables (100% polyester, sans repassage)

Linélys



On adore:

- Traitement non-feu M1
- Effet lin naturel



Caractéristiques:

100% polyester **aspect lin**
 Largeur: 145cm ou 300cm
 Poids: 220gr/m2
 SANS REPASSAGE

Idéal pour:

Restaurants
 Hôtellerie
 Collectivités

(Coloris à imprimer sur fond blanc, vanille ou beige)



Tamilys



On adore:

- Traitement non-feu M1
- Effet coton



Caractéristiques:

100% polyester **aspect coton**
 Largeur: 150cm
 Poids: 220gr/m2
 SANS REPASSAGE

Idéal pour:

Hôtellerie
 Collectivités

Firelys



On adore:

- Traitement non-feu M1
- Léger, fluide



Caractéristiques:

100% polyester **aspect maille**
 Largeur: 150 et 175cm
 Poids: 220gr/m2
 SANS REPASSAGE

Idéal pour:

Collectivités
 Evènementiel

Occultant PVC ou Tissu



On adore:

- Traitement non-feu M1
- Obscurcissant



Caractéristiques:

100% polyester
 Largeur: 145cm
 Poids: 240gr/m2
 SANS REPASSAGE

Idéal pour:

Hôtellerie
 Collectivités

+ de motifs dans Nappes > Les Imprimables



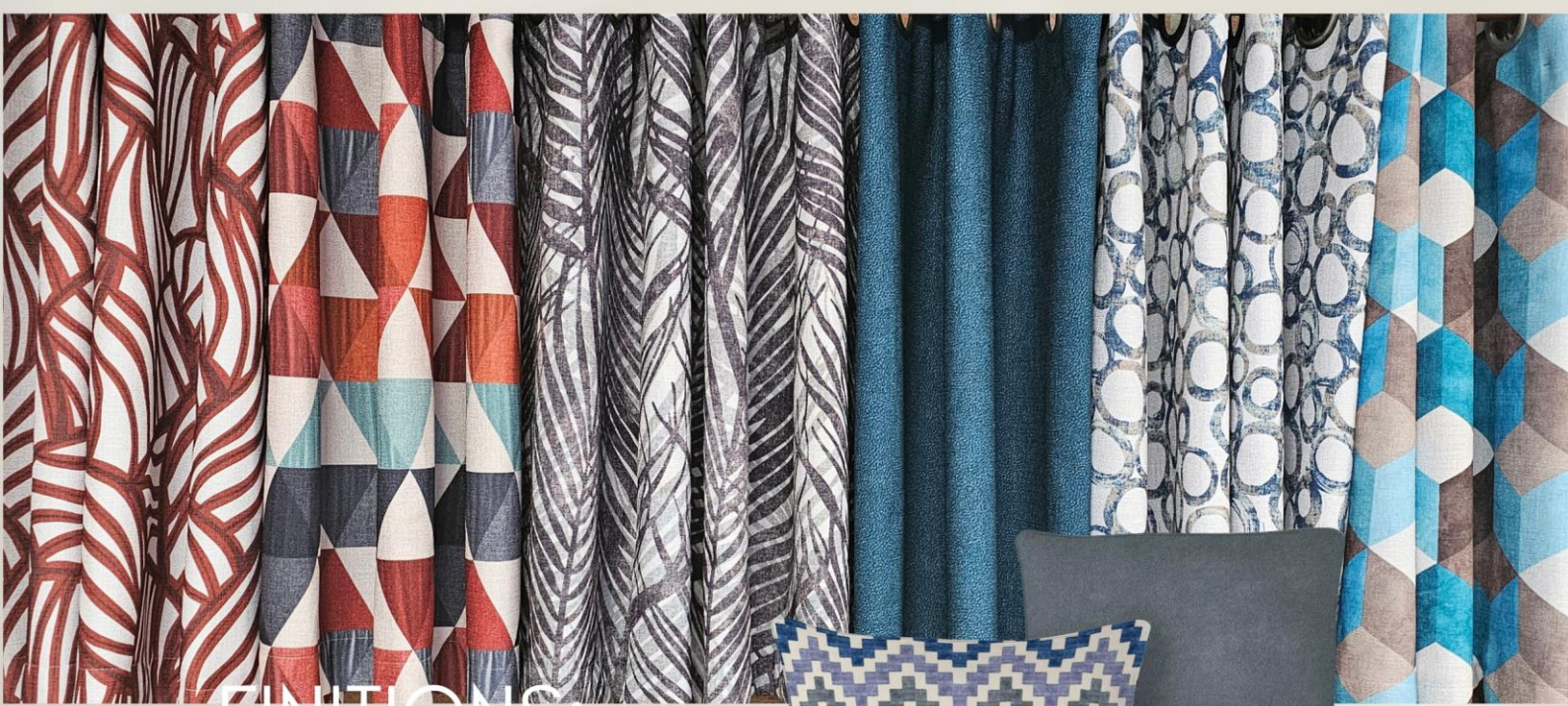

FINITIONS:



Ruflette à plis



Oeillet

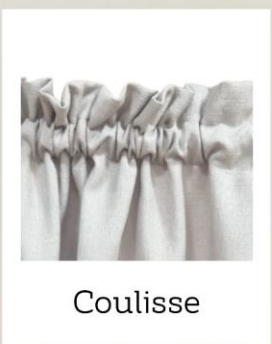

Coulisse



Patte invisible



Tetris

Boréal

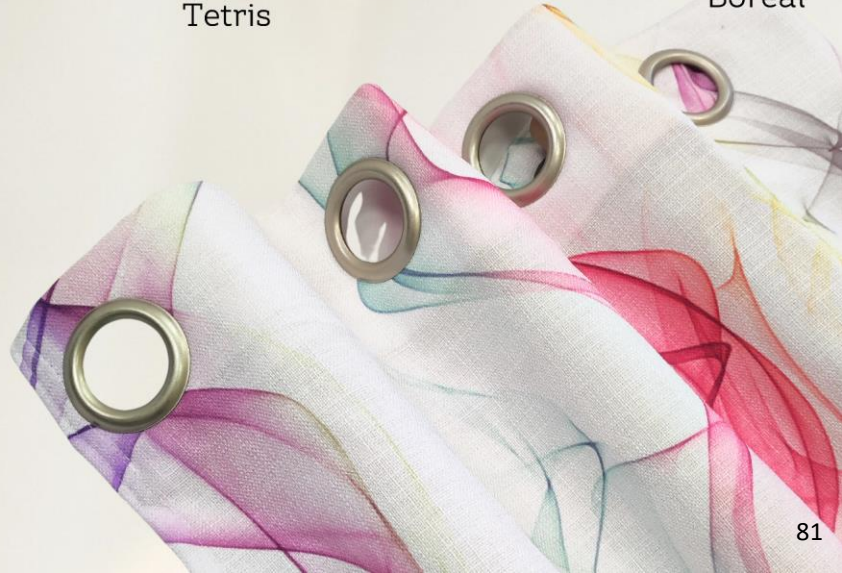

Embrasses *à rideaux*

Embrasse en tissu - Gammes Les Imprimables & Atypiques



Bandeau



Romance



Nœud



Papillon

Embrasse PVC effet cuir - Gamme SONOTAN



Trio



Ceinture



Croisé



Feuille



100% Polyester

Hauteur/Height: 280cm

NON FEU M1
Flame-retardant

Lavage industriel autorisé
Industrial washing allowed

Lavable à 30°C - 800T/mn
Washable at 30°C - 800 rpm

Infroissable
Wrinkle-resistant

Voilage *polyester*



1. Choix du tissu:



Voile



Etamine



Tergal Lin



Option:
Plombé

2. Choix de la confection:



Pli Ruflette



Pli Relief



Œillet



Coulisse

Coussins dépoussable



Enveloppe



Volant droit



Pressions latérales



Passe-poil



Volant plissé



84 Pressions centrales



Confectionné
en France

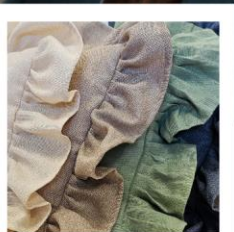

Nos tissus
au choix

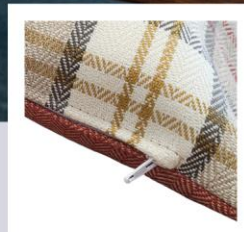

Option zip



Qualité pro

30x30cm

45x45cm

50x50cm

30x50cm

25x40cm

Confectionnés sur-mesure dans notre atelier

Gamme *Doulyss*

Polaire pour couverture et plaid
Fleece for blanket and plaid

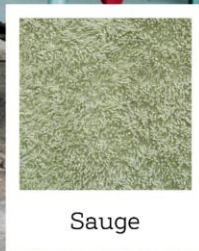

Idéal pour plaid en terrasse
Ideal for blanket on terrace

100% microfibre polyester
Polyester microfiber fabric

Effet velours polaire
Fleece velvet effect

Largeur, width: 150cm
Poids, weight: 260gr/m²

Lavable à 30°C / 800T/mn
Washable at 30°C / 800 rpm

Galette *de chaise*

Réalisations sur-mesure



Non déhoussable
épaisseur 2cm
Gamme MAGILYS

Déhoussable
épaisseur 3 ou 5cm
TOUTES GAMMES



Option:
à nouer



Option:
antidérapant

Galette envers anti-dérapant
+ coloris: gamme MAGILYS

Housse *de chaise*

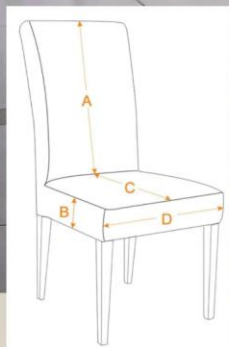

Prise de vos mesures

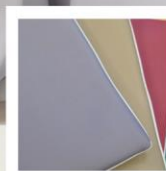

Magilys
Infroissable

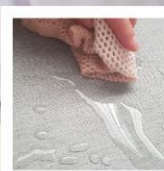

Sonoclean
Imperméable



Option:
Bandeau

Droit



Droit court



Pli creux





Les tabliers

Aprons

La Collection
The Collection

p. 90

Je crée mon tablier
I design my apron

p. 113

Formes & poches
Shapes & pockets

p. 114-115

Tissus & coloris
Fabrics & colors

p. 116-117

Attaches & sangles
Fasteners & straps

p. 118

Personnalisation logo
Logo customization

p. 119



LA COLLECTION

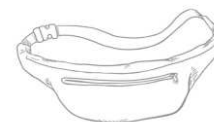

ref. BAN

P.91



P.92

ref. : NOE_

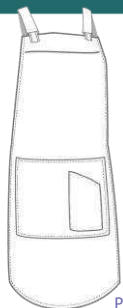

P.96

ref. : BOB_

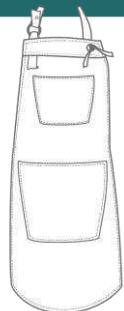

P.96

ref. : MAX_



P.95

ref. : PIA_



P.98

ref. : MEO_

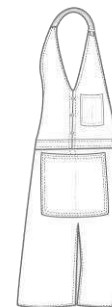

P.95

ref. : GIL_



P.109

ref. : GED_

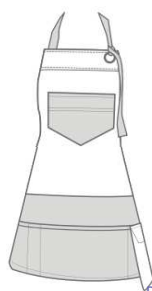

P.109

ref. : NED_

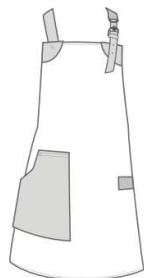

P.98

ref. : POL_

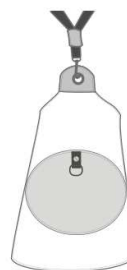

P.100

ref. : ULY_



P.100

ref. : SID_

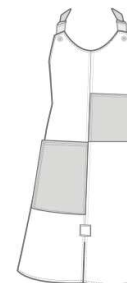

P.94

ref. : ACY_

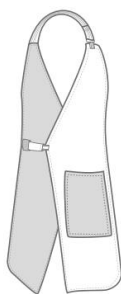

P.99

ref. : PAM_

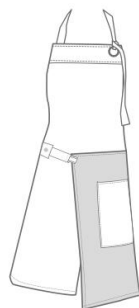

P.99

ref. : POM_



P.97

ref. : ART_



P.101

ref. : TAN_

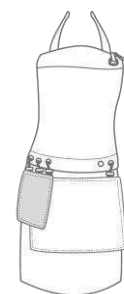

P.94

ref. : KIM

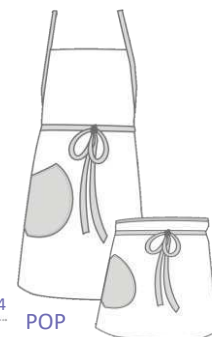

POP
P.104

FUN
P.105



P.108

ref. : EDY_



P.108

ref. : MAE_



P.102

ref. : BIL_



P.102

ref. : FLO_



P.103

ref. : NIL



P.103

ref. : NAT



Fait main en France
Handmade in France

BAN

Description

- Sacoche bandoulière réglable
- Fermeture éclair
- Contient 1 poche intérieure
- Mixte
- *Adjustable shoulder bag*
- *Zipper closure*
- *Contains 1 inside pocket*
- *Mixed*

Gamme / Range SONOSKAÏ
100% PVC effet cuir grainé



Gamme / Range CUIRLYS
100% polyester effet peau tannée





Fait main en France
Handmade in France



NOE

Bicolore

Description

- Tablier mixte. Taille Unique.
- 1 grande poche ventrale
- Tour de cou et sangles ajustables, à nouer.
- *Mixed apron. One size.*
- *1 large ventral pocket*
- *Adjustable straps to tie*



Gamme / Range SONOJEAN
50% Polyester 50% Coton



Gamme / Range CUIRLYS
100% polyester effet peau tannée



Description

- Tablier mixte. Taille Unique.
- 1 grande poche ventrale
- Tour de cou et sangles ajustables, à nouer.
- *Mixed apron. One size.*
- *1 large ventral pocket*
- *Adjustable straps to tie*

NOE

Unicolore



Bandeau tête en option
Optional headband



Fait main en France
Handmade in France

NOE

Imprimé

Description

- Tablier mixte. Taille Unique.
- 1 grande poche ventrale
- Tour de cou et sangles ajustables, à nouer.
- Mixed apron. One size.
- 1 large ventral pocket
- Adjustable straps to tie

Ref.: NOE_LINOR/SINR

Ref.: NOE_LIIND/SKCM

Ref.: NOE_LIARC/SJFO

Ref.: NOE_LIIRI/SIAG

Ref.: NOE_LIAOU/SISR



Ref.: NOE_LIORI/SJFO



Ref.: NOE_LISPO/SINR



Ref.: NOE_LISAV/SIDM



Ref.: NOE_LICASC/SIKCM



Ref.: NOE_LIROS/SKCM



Ref.: NOE_LIBUFBR/SIDM



Fait main en France
Handmade in France

Description

- Tablier mixte avec poches amovibles (1 large poche ventrale, 1 petite poche latérale, 1 porte-clé).
- Tour de cou réglable à nouer sur un oeillet.
- Mixed apron with removable pockets (1 large ventral pocket, 1 small side pocket, 1 keychain).
- Adjustable choker to tie on an eyelet.

KIM

Gamme / Range SONOJEAN
50% Polyester 50% Coton



Gamme / Range CUIRLYS
100% polyester effet peau tannée



Gamme / Range SODENIM
80% coton 20% polyester



Description

- Tablier mixte.
- 2 poches damier
- Sangles croisées dans le dos.
- Fente de marche
- Mixed apron.
- 2 checkerboard pockets
- Crossed back straps.
- Walking slot

ACY





Fait main en France
Handmade in France

Description

- Tablier mixte.
- Tour de cou par pressions et sangles ajustables, à nouer.
- *Mixed apron.*
- *Adjustable neckband with snaps and tie straps.*

PIA



Gamme / Range SONOJEAN
50% Polyester 50% Coton



Gamme / Range CUIRLYS
100% polyester effet peau tannée



Description

- Tablier mixte.
- 1 grande poche ventrale
- Tour de cou et sangles ajustables, à nouer.
- *Mixed apron.*
- *1 large ventral pocket*
- *Adjustable straps to tie*

GIL



Fait main en France
Handmade in France

Description

- Tablier mixte . Taille Unique.
- 1 large poche ventrale
- 1 poche poitrine
- Tour de cou réglable, sangles à nouer dans le dos.
- *Mixed apron . One size.*
- *1 large front pocket*
- *1 breast pocket*
- *Adjustable choker, tie-back straps.*

MAX



Gamme / Range CUIRLYS
100% polyester effet peau tannée



Gamme / Range SONOCLEAN
100% PVC effet tissu ou cuir



Description

- Tablier mixte. Taille Unique.
- 1 large poche ventrale
- 1 poche latérale
- Bretelles élastiquées réglables et croisées dans le dos.
- *Mixed apron. One size.*
- *1 large ventral pocket + 1 lateral*
- *Adjustable elasticated straps, crossed at the back.*

BOB





Boucle ceinture ajustable
Adjustable belt buckle



Fait main en France
Handmade in France

ART

Description

- Tablier mixte.
- 2 poches ventrales
- Tour de cou boucle ceinture et sangles ajustables, à nouer.
- Mixed apron.
- 2 ventral pockets
- Adjustable straps to tie



Gamme / Range SODENIM
80% coton 20% polyester



Gamme / Range CUIRLYS
100% polyester effet peau tannée



Gamme / Range SONOTAN (cuir synthétique ép.2mm)
86% PVC - 12% Polyester - 2% Polyurethane



Ref.: ART_SDNR/TARG



Ref.: ART_SDMT/TANR



Ref.: ART_SDCC/TANR



Ref.: ART_SDKK/TACM



Ref.: ART_SDEC/TAMN



Ref.: ART_SDBL/TAAG



Fait main en France
Handmade in France

Description

- Tablier mixte.
- 1 poche latérale.
- Tour de cou boucle ceinture et sangles ajustables.
- *Mixed apron.*
- *1 side pocket*
- *Adjustable straps to tie*

POL

Gamme / Range SONOTAN (cuir synthétique ép.2mm)
86% PVC - 12% Polyester - 2% Polyurethane



Gamme / Range CUIRLYS
100% polyester effet peau tannée



Gamme / Range SODENIM
80% coton 20% polyester



Description

- Tablier mixte.
- 1 double poche ventrale + 1 petite poche.
- Sangles croisées dans le dos.
- *Mixed apron.*
- *1 double ventral pocket + 1 small pocket*
- *Crossed back straps.*

MEO





Fait main en France
Handmade in France

Description

- Tablier Femme.
- 1 poche latérale
- Tour de cou pince bretelle et sangles ajustables, à nouer.
- *Woman apron.*
- *1 side pocket*
- *Adjustable straps to tie*

PAM



Personnalisable: voir NOS TISSUS
Customizable: see OUR FABRICS

- Les Imperméables / *Waterproof*
- Les Imprimables / *Printables*
- Les Atypiques / *Atypics*
- Les Basiques / *Basics*
- Les Naturels / *Naturals*

Description

- Tablier mixte.
- 1 poche latérale
- Tour de cou et sangles ajustables, à nouer.
- *Mixed apron.*
- *1 side pocket*
- *Adjustable straps to tie*

POM





Fait main en France
Handmade in France

Description

- Tablier mixte style "Boucher"
- 1 grande poche ventrale Ovale
- Sangles ajustables, à nouer dans le dos.
- *Mixed apron.*
- *1 large ventral pocket*
- *Adjustable straps to tie*

SID



Gamme / Range SONOTAN (cuir synthétique ép.2mm)
86% PVC - 12% Polyester - 2% Polyurethane



Gamme / Range CUIRLYS
100% polyester effet peau tannée



Gamme / Range SODENIM
80% coton 20% polyester



Description

- Tablier mixte.
- 1 grande poche ventrale Ovale
- Tour de cou et sangles ajustables, à nouer.
- *Mixed apron.*
- *1 large ventral pocket*
- *Adjustable straps to tie*

ULY





Fait main en France
Handmade in France



TAN

Description

- Tablier Femme (pince poitrine)
- 1 poche latérale
- Sangles avec boucle ceinture.
- *Woman apron*
- *1 side pocket*
- *Straps with belt buckle.*



Gamme / Range SONOTAN (cuir synthétique ép.2mm)
86% PVC - 12% Polyester - 2% Polyurethane



Gamme / Range SONOSKAÏ
100% PVC effet cuir grainé



Description

- Tablier Homme.
- 1 poche latérale
- Sangles avec boucle ceinture.
- *Woman apron*
- *1 side pocket*
- *Straps with belt buckle.*

TOM





Fait main en France
Handmade in France

Description

- Tablier mixte
- 1 double poche ventrale + 1 latérale
- Bretelles réglables autour de la taille.
- Fente de marche sur le devant.
- *Mixed apron*
- *1 double ventral pocket + 1 side pocket.*
- *Adjustable straps around the waist.*
- *Front walking slot*

FLO



Gamme / Range SONOJEAN
50% Polyester 50% Coton



Gamme / Range CUIRLYS
100% polyester effet peau tannée



Gamme / Range SONOSKAÏ
100% PVC effet cuir grainé



Description

- Tablier mixte.
- 1 double poche ventrale + 1 latérale
- Bretelles réglables autour de la taille.
- *Mixed apron.*
- *1 double ventral pocket + 1 side pocket*
- *Adjustable straps around the waist.*

BIL





Fait main en France
Handmade in France

Description

- Tablier mixte
 - 1 double poche ventrale + 1 latérale
 - Sangles à nouer.
- *Mixed apron*
 - *1 ventral pocket + 1 side pocket.*
 - *Straps to tie.*

NAT



Gamme / Range SONOJEAN
50% Polyester 50% Coton



Gamme / Range CUIRLYS
100% polyester effet peau tannée



Gamme / Range SONOSKAÏ
100% PVC effet cuir grainé



Description

- Tablier mixte.
- 1 poche latérale
- Sangles à nouer.

- *Mixed apron.*
- *1 side pocket*
- *Adjustable straps to tie.*

NIL





Fait main en France
Handmade in France

Description

- Tablier mixte. Taille Unique.
- 1 poche ronde latérale.
- Tour de cou et sangles ajustables, à nouer.
- *Mixed apron. One size.*
- *1 side round pocket*
- *Adjustable straps to tie*

POP



ARDOISE

Ref.: POP SIAR/SINR



BRUME

Ref.: POP SIBM/SINR



GOLD

Ref.: POP SIGD/SINR



DAIM

Ref.: POP SIDM/SINR



AMETHYSTE

Ref.: POP SIAM/SINR



PAON

Ref.: POP SIPN/SINR



BRIQUE

Ref.: POP SIBQ/SINR



CURCUMA

Ref.: POP SICR/SINR



ARGENT

Ref.: POP SIAG/SINR

Personnalisable: voir NOS TISSUS
Customizable: see OUR FABRICS



Fait main en France
Handmade in France

- Les Imperméables / Waterproof

Description

FUN

- Tablier mixte. Taille Unique.
- 1 poche ronde latérale.
- Tour de cou et sangles ajustables, à nouer.
- *Mixed apron. One size.*
- *1 side round pocket*
- *Adjustable straps to tie*

DAIM
Ref.: FUN SIDM/SINR



GOLD
Ref.: FUN SIGD/SINR



ARGENT
Ref.: FUN SIAG/SINR



BRIQUE
Ref.: FUN SIBQ/SINR



AMETHYSTE
Ref.: FUN SIAM/SINR



CURCUMA
Ref.: FUN SICR/SINR



PAON
Ref.: FUN SIPN/SINR



BRUME
Ref.: FUN SIBM/SINR



ARDOISE
Ref.: FUN SIAR/SINR

Personnalisable: voir NOS TISSUS
Customizable: see OUR FABRICS



Fait main en France
Handmade in France

- Gamme CUIRLYS



CUIRLYS GRIS
Ref.: ROB CUGR/SINR

ROB

Description

- Tablier mixte
- 1 poche ventrale
- Sangles à nouer.
- Unisex apron
- 1 ventral pocket
- Straps to tie.



CUIRLYS NOIR
Ref.: ROB CUNR/SINR



CUIRLYS CAMEL
Ref.: ROB CUCM/SINR



CUIRLYS VANILLE
Ref.: ROB CUVN/SINR



CUIRLYS CHOCOLAT
Ref.: ROB CUCC/SINR

Description

- Tablier mixte.
- 1 poche latérale
- Sangles à nouer.
- Unisex apron.
- 1 lateral pocket
- Adjustable straps to tie.

KAT





Fait main en France
Handmade in France

Description

- Tablier Mixte
- 1 poche ventrale
- à enfiler
- *Unisex apron*
- *1 side pocket*
- *Straps with belt buckle.*

VAL



Gamme / Range SONOJEAN
50% Polyester 50% Coton



Gamme / Range CUIRLYS
100% polyester effet peau tannée



Description

- Tablier Mixte.
- 1 poche ventrale
- Sangles croisées devant, à nouer dans le dos
- *Unisex apron*
- *1 ventral pocket*
- *Crossed straps at front, tie at back*

ROZ





Fait main en France
Handmade in France



EDY

Description

- Ceinture tablier mixte
- Multi poches
- Sangles à nouer
- Unisex apron belt
- Multi pockets
- Tie straps



Gamme / Range SONOJEAN
50% Polyester 50% Coton



Gamme / Range CUIRLYS
100% polyester effet peau tannée



Gamme / Range SONOSKAÏ
100% PVC effet cuir grainé



Description

- Sacoche multi poches
- S'accroche à la ceinture (non fournie) grâce à 2 boutons pressions.
- Multi-pocket bag
- Attaches to belt (not supplied) with 2 snap fasteners.

MAE





Fait main en France
Handmade in France



GED

Description

- Tablier gilet multipoches
- Sangles à nouer dans le dos
- Bretelles élastiquée réglable pour le tour de cou
- *Multi-pocket vest apron*
- *Tie-back straps*
- *Adjustable elasticized neck straps*

Gamme / Range SONOJEAN
50% Polyester 50% Coton



Gamme / Range CUIRLYS
100% polyester effet peau tannée



Gamme / Range SONOSKAÏ
100% PVC effet cuir grainé



Description

- Tablier bavette multipoches
- Sangles à nouer dans le dos
- Tour de cou réglable, à nouer
- *Multi-pocket bib apron*
- *Tie-back straps*
- *Adjustable choker with tie*

NED



BISTRO

Rouge

Description

- Tablier Mixte 100% coton
- 1 poche ventrale
- Tour de cou réglable, sangles à nouer
- *Unisex apron, 100% cotton*
- *1 ventral pocket*
- *Adjustable choker, tie straps*

Description

- Tablier Mixte 100% coton
- 1 poche ventrale
- Tour de cou réglable, sangles à nouer
- *Unisex apron, 100% cotton*
- *1 ventral pocket*
- *Adjustable choker, tie straps*

BISTRO

Noir





Fait main en France
Handmade in France

MAG

NOUVEAU: SANS SANGLES
se clipe sur vos vêtements!

Description

- Tablier mixte SANS SANGLES: attaches pinces-clip
 - 1 poche double ventrale
 - 1 clip latéral pour torchon
 - ULTRA LEGER
-
- *Mixed apron WITHOUT STRAPS: clip fasteners to attach to your clothes.*
 - *1 double ventral pocket*
 - *1 side clip for kitchen towel*
 - *ULTRA LIGHT*



Personnalisable: voir NOS TISSUS
Customizable: see OUR FABRICS

- Les Imprimables / *Printables*
- Les Atypiques / *Atypics*
- Les Basiques / *Basics*
- Les Naturels / *Naturals*



Description

- Tablier mixte ample
 - 2 poches latérales
 - Bretelles croisées dans le dos, à enfiler
-
- *Loose-fitting mixed apron*
 - *2 side pockets*
 - *Slip-on cross-back straps*

ZEN



Gamme Maya

Coton épais

Mix & Match

- Ext: Pampa écru
- Int: Maya Olive



ART - Maya Olive
Sangles Camel



ART - Maya Safran
Sangles Camel



ART - Maya Bleuet
Sangles Camel



Maya Olive



Maya Safran



Maya Bleuet

100% Coton épais
Poids: 315 g/m²
Laize: 150cm

Lavable en machine à 30C°
Essorage 800 T/mn
Repassage classique

100% Thick cotton
Weight: 315 g/m²
Width: 150cm

Machine washable at 30C°.
Spin 800 rpm
Classic ironing

Autres formes et dimensions,
nous consulter.



Panière Ø15cm
Maya Olive



Panière Ø15cm
Maya Safran



Panière Ø15cm
Maya Bleuet



Option:
étiquette personnalisable
customizable label



JE CRÉE MON TABLIER

I create my own apron

Tadam

The End.



1.

La Base

Shape

2.

Les Poches

Pockets

3.

Les Tissus

Fabrics

4.

Les Attaches

Fasteners

5.

Mon Logo

Customization

JE CRÉE MON TABLIER

1. Je choisie la base / I choose the base



ref.: NOE_

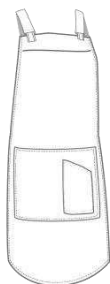

ref.: BOB_

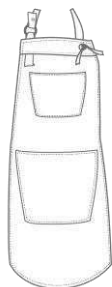

ref.: MAX_



ref.: PIA_

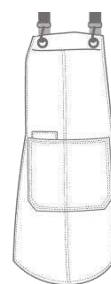

ref.: MEO_

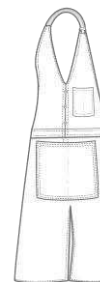

ref.: GIL_



ref.: GED_



ref.: NED_



ref.: POL_



ref.: ULY_



ref.: SID_

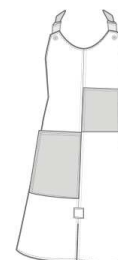

ref.: ACY_

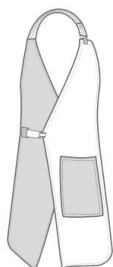

ref.: PAM_



ref.: POM_



ref.: ART_

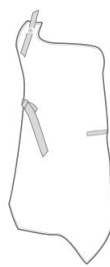

ref.: TAN_



ref.: KIM



POP

FUN



ref.: EDY_



ref.: MAE_



ref.: BIL_



ref.: FLO_



ref.: NIL



ref.: NAT



ref.: BAN

JE CRÉE MON TABLIER

2. Avec ou sans poche / With or without pocket

Les poches poitrine



ref. : PP1_
Simple poitrine droite ou gauche
Single chest pocket, right or left



ref. : PP2_
Double poitrine droite ou gauche
Double chest pocket, right or left



ref. : PP3_
Poche poitrine centrale
Central chest pocket

Les poches latérales

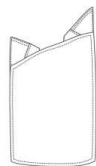

ref. : PL3_
Soufflet latérale droite
Right side bellows pocket

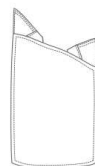

ref. : PL4_
Soufflet latérale gauche
Left side bellows pocket

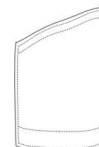

ref. : PL1_
Latérale droite
Right side pocket

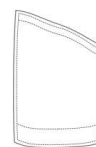

ref. : PL2_
Latérale gauche
Left side pocket

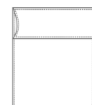

ref. : PL4_
Poche à rabat
Flap side

Les poches ventrales

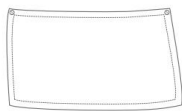

ref. : PV1_
Ventrale
Ventral

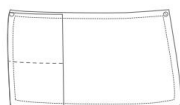

ref. : PV2_
Ventrale + Latérale droite
Ventral + right side pocket

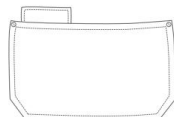

ref. : PV3_
Ventrale + sous poche droite
Ventral + Right side under pocket

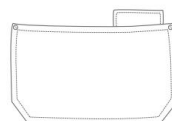

ref. : PV4_
Ventrale + sous poche gauche
Ventral + Left side under pocket

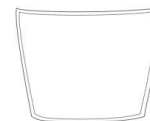

ref. : PV5_
Poche ventrale évasée
Flared ventral pocket

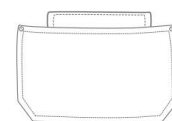

ref. : PV6_
Ventrale + sous poche
Ventral + under pocket

Les poches ventrales à onglets



ref. : POV1_
Ventrale 2 onglets
2 tabs ventral pocket

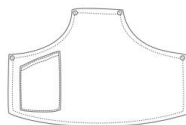

ref. : POV2_
Ventrale 2 onglets
+ poche latérale droite
2 tabs ventral pocket
+ right side pocket



ref. : POV3_
Ventrale 2 onglets
+ poche latérale gauche
2 tabs ventral pocket
+ left side pocket



ref. : POV4_
Ventrale ovale
Ventral oval

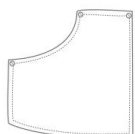

ref. : POL1_
Ventrale 1 onglet droit
1 tab right pocket

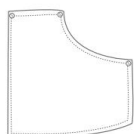

ref. : POL2_
Ventrale 1 onglet gauche
1 tab left pocket

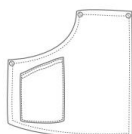

ref. : POL3_
Ventrale onglet droit
+ poche latérale droite
1 tab right pocket + right side pocket

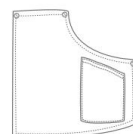

ref. : POL4_
Ventrale onglet gauche
+ poche latérale gauche
1 tab left pocket + left side pocket

JE CRÉE MON TABLIER

3. Tissus & coloris / Fabrics & colors

Linélys Uni ou Motif



On adore:

- Déperlant
- Effet lin naturel



Caractéristiques:

100% polyester **effet lin**
 Largeur: 145cm ou 300cm
 Poids: 220gr/m2
SANS REPASSAGE

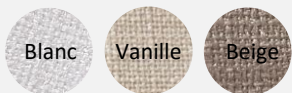

Coloris (à imprimer sur fond blanc, vanille ou beige):



Demilys



Caractéristiques:

50% polyester 50% coton
Sobre et raffiné
 Largeur: 280cm
 Poids: 240gr/m2

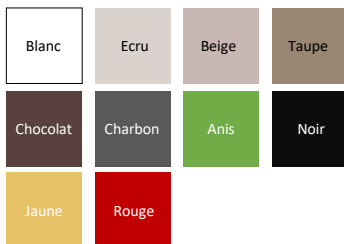

Sonomixt

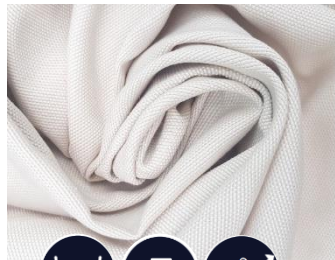

Caractéristiques:

50% polyester 50% coton
Effet nid d'abeille
 Largeur: 280cm
 Poids: 225gr/m2



Sodenim

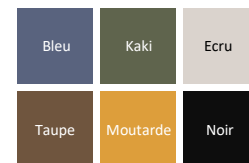
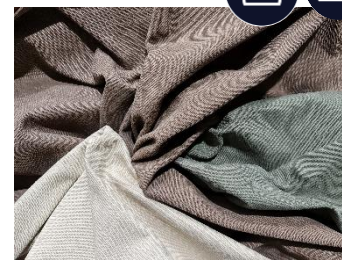

Caractéristiques:

80% coton 20% polyester
 Largeur: 150cm
 Poids: 470gr/m2

Sonojean



Bleu **Noir** 55% coton
 45% coton

JE CRÉE MON TABLIER

3. Tissus & coloris / Fabrics & colors

Sonoclean

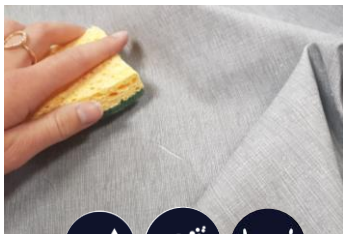

Caractéristiques:

100% PVC aspect tissu ou cuir
Poids: 550gr/m2
IMPERMEABLE



Sonoskaï

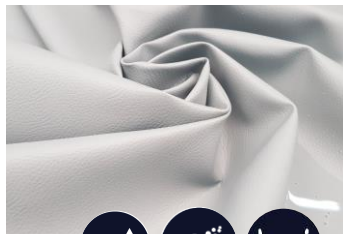

Caractéristiques:

100% PVC aspect cuir grainé
Poids: 400gr/m2
IMPERMEABLE



Velys



Caractéristiques:

100% polyester velours côtelé
Largeur: 140cm
Poids: 330gr/m2
SANS REPASSAGE

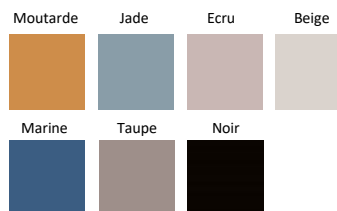

Cuirlys



Caractéristiques:

100% polyester aspect peau
Largeur: 140cm
Poids: 235gr/m2
SANS REPASSAGE



Sonostyle

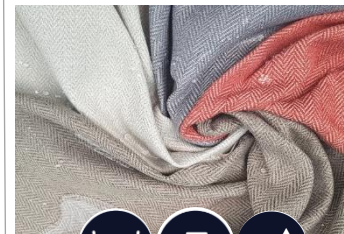

Caractéristiques:

100% polyester effet laine
Largeur: 138cm
Poids: 420gr/m2
SANS REPASSAGE
Traitement TEFLON



Bistrot



Caractéristiques:

100% coton
Largeur: 180cm
Poids: 210gr/m2
Repassage superflu

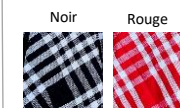

JE CRÉE MON TABLIER

4. Je choisis le système d'attaches / I choose the fastening system

Emplacement des sangles:



ou/or



Fixations réglables:



A nouer sur un œillet
To tie on an eyelet



Pince-bretelle
A suspender clip



Languette à scratch
Velcro tongue



Mousqueton
A carabiner



Boucle ceinture
Belt buckle



Bouton pression
Around the neck

Coloris des sangles en coton:



Blanc
White



Beige



Taupe



Chocolat
Chocolate



Camel



Bleu
Blue



Noir
Black



Moutarde
Mustard



Kaki



Rouge
Red



Bordeaux



Gris
Grey

JE CRÉE MON TABLIER

5. Je personnalise avec mon logo / I personalize with my logo

Sérigraphie couleur / Colors silkscreen



Pour cela, nous avons besoin:

- Fichier haute définition (.AI .EPS .PDF)
- Emplacement et dimensions du logo
- Couleur du logo (si sérigraphie/broderie)

To do this, we need :

- High-resolution file (.AI .EPS .PDF)
- Logo location and dimensions
- Logo color (if silkscreen/embroidery)



Broderie / Embroidery



Gravure laser / engraving

Procédé de marquage par brûlage à l'aide d'un faisceau laser. Marquage permanent et profond. Sans choix de couleur. *Laser beam burning marking process. Permanent, deep marking. No choice of color.*

SONOLYS



Made in
France



Personnalisable



Artisanat
familial



Résistant &
réutilisable



à 20km de Lille

CONTACT

+33 3 21 63 16 16
valerie@sonolys.com

SONOLYS
4075 rue de la Lys,
62840 Sailly-sur-la-Lys
(Hauts-de-France), France