



CATÁLOGO 2025
SIN PRECIO



**Mantén el catálogo
siempre actualizado**



**Keep the catalogue
always updated**



INSPIRING CREATORS



En Comas existimos para inspirar y empoderar a los creadores culinarios profesionales, aquellos que quieren dar rienda suelta a su pasión creativa y persiguen la excelencia culinaria en cada gesto, en cada plato, en cada detalle.

Desde hace más de treinta años, siendo fieles a nuestros principios, creemos que el futuro está lleno de nuevas oportunidades, desafíos y aprendizajes.

Nos apasiona pensar en lo que está por venir y, para ello, hemos redefinido nuestra estrategia y nuestra identidad de marca que os presentamos en este catálogo 2025.

Comas, Inspiring Creators no es solo un lema, es nuestra promesa y es nuestro propósito. Queremos ser una fuente de inspiración para los profesionales excelentes a los que servimos y, al mismo tiempo, nos dejamos inspirar por todos vosotros.

Juntos queremos construir el futuro de la creatividad culinaria, y para ello tenemos los mejores productos e ingredientes, esto es Comas.

At Comas we exist to inspire and empower professional culinary creators, those who want to unleash their creative passion and pursue culinary excellence in every gesture, in every dish, in every detail.

For more than thirty years, being faithful to our principles, we have believed that the future is full of new opportunities, challenges and learning.

We are passionate about thinking about what is to come and, to this end, we have redefined our strategy and our brand identity, which we present you in this 2025 catalogue.

Comas, Inspiring Creators is not just a slogan, it is our promise and our purpose. We want to be a source of inspiration for the excellent professionals we serve, and, at the same time, we allow ourselves to be inspired by all of you.

Together we want to build the future of culinary creativity, and for this we have the best products and ingredients, this is Comas.

Dani Comas, CEO

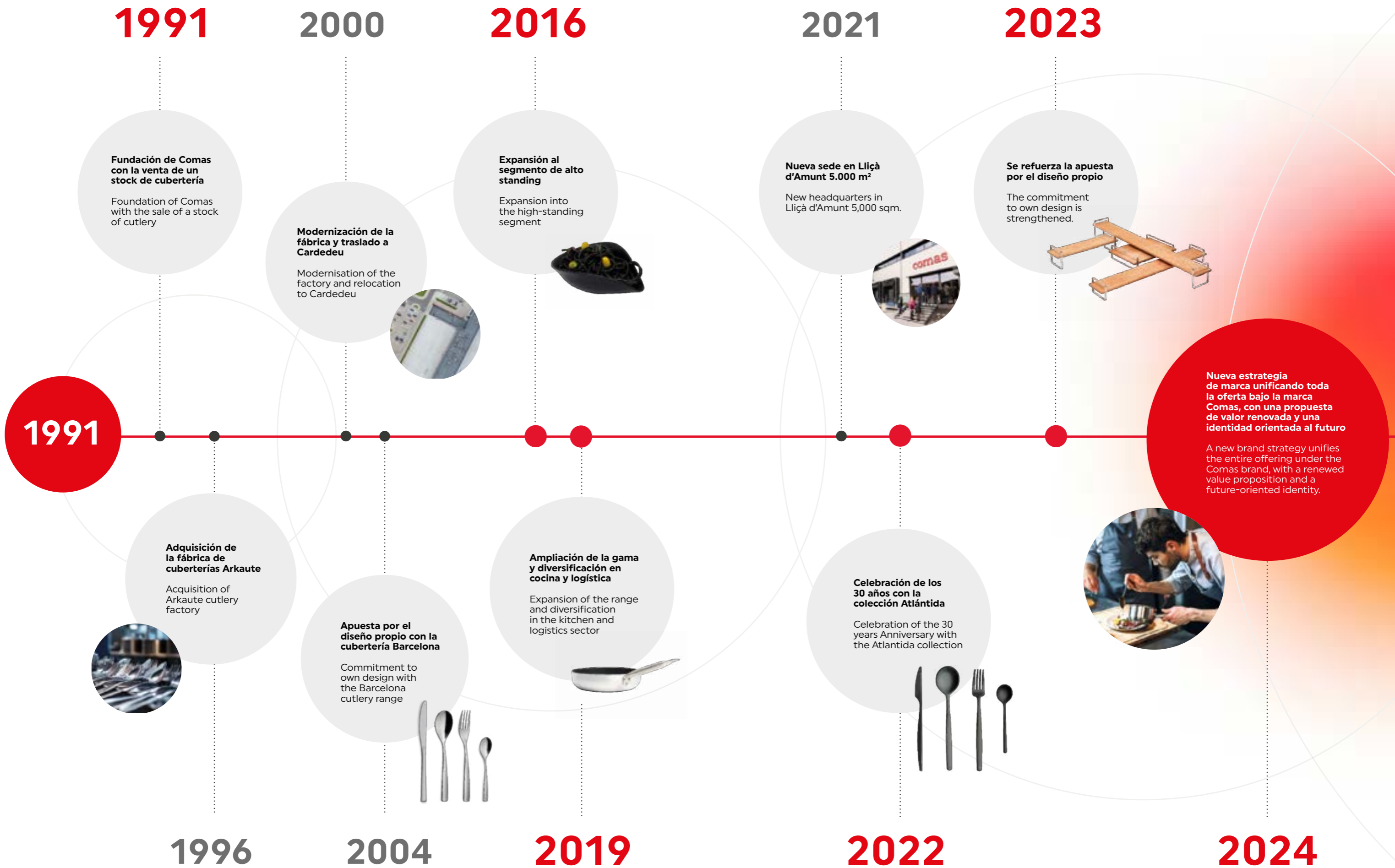

Nuestra promesa

Somos el socio global para creadores profesionales en la parte posterior, frontal y central de la industria hotelera.

Our promise

We are the global partner for creative professionals at the back, front and centre of the hospitality industry.

La forma de ser y de hacer

En Comas compartimos con nuestros clientes la búsqueda constante de lo extraordinario. Aprendemos y mejoramos juntos compartiendo conocimientos, superando desafíos y acumulando experiencias.

Creemos en el valor de reconocer y potenciar el talento, colaborando con expertos, universidades, diseñadores y de una selecta red de aliados.

En Comas, siempre estamos al lado de los profesionales porque esta es nuestra esencia.

The way we are and the way we do

At Comas we share with our clients the constant pursuit of the extraordinary. We learn and improve together by sharing knowledge, overcoming challenges and accumulating experience.

We believe in the value of recognising and promoting talent, collaborating with experts, universities, designers and a select network of allies.

At Comas, we are always at the side of professionals because this is our essence.

El conocimiento integrador

Diseñamos, producimos y comercializamos productos buscando la escalabilidad, eficiencia, calidad y competitividad. Así aportamos soluciones efectivas para satisfacer las necesidades de los profesionales más exigentes.

Nuestro portafolio, en constante evolución, abarca cubertería, cocina, logística, sala, bar, buffet, catering y brasa, y continuará creciendo para cubrir las futuras necesidades que puedan surgir de los profesionales porque esta es nuestra esencia.

Integrating knowledge

We design, produce and market products seeking scalability, efficiency, quality and competitiveness. This is how we provide effective solutions to satisfy the needs of the most demanding professionals.

Our constantly evolving portfolio covers cutlery, kitchen, logistics, dining room, bar, buffet, catering and grill, and will continue to grow to meet future needs that may arise.



ELISAVA

Escuela Universitaria de Barcelona
Diseño e Ingeniería



Innovación con propósito

En Comas, apostamos por un diseño que marca la diferencia. Con un equipo interno y colaboraciones externas, creamos colecciones únicas. Desde 2018, nuestros productos han recibido premios de diseño, consolidando nuestro prestigio y creatividad.

Colaboramos con universidades de diseño e ingeniería, desafiando a los estudiantes con retos y proyectos innovadores. Estas alianzas nos permiten crecer juntos en un entorno de aprendizaje mutuo.

Innovation with purpose

At Comas, we are committed to design that makes a difference. With an in-house team and external collaborations, we create unique collections. Since 2018, our products have received design awards, consolidating our prestige and creativity.

We collaborate with design and engineering universities, challenging students with innovative challenges and projects. These partnerships allow us to grow together in a mutual learning environment.

Premios / Awards



2018 ASTER 	2018 MAGNOLIA 	2020 SAKURA 	2020 LAB 	2021 LAB ACCESSORIES 
---	--	--	---	---



2019 BAOBAB 	2019 KODAI 	2020 LAB 
--	---	---





2021 LES ESSENCES 
--



2018 BAOBAB 	2023 ATLÁNTIDA 	2023 BOLETUS 	2024 PLAISIR 
--	---	---	---



2019 ASTER 	2023 BAUHAUS 
---	---



2022 ATLÁNTIDA 	2024 PLAISIR 
---	---



NACAR

Agencia de diseño estratégico especializada en diseño industrial, soluciones digitales e innovación. Top 25 global según iF Awards.

Strategic design agency specialising in industrial design, digital solutions and innovation. Top 25 global according to iF Awards.

Comas y la apuesta por el diseño

Apostamos por diseñadores, por talento, por la experiencia de creadores que nos inspiran y dan forma a nuestras ideas y soluciones, con un carácter único.

Comas and the commitment to design

We are committed to designers, to talent, to the experience of creators who inspire us and give shape to our ideas and solutions, with a unique character.



CHRISTOPHE MATHIEU

Interiorista belga, dedicado al diseño industrial, basado en Barcelona. Trabajó años en Milán con estudios de arquitectura y diseño.

Belgian interior designer, dedicated to industrial design, based in Barcelona. He worked for years in Milan with architecture and design studios.



ULI MARCHSTEINER

Diseñador austríaco residente en España con foco en vajilla, cristalería, cubertería, mobiliario e iluminación. Experto en curaduría.

Austrian designer based in Spain with a focus on tableware, glassware, cutlery, furniture and lighting. Curatorial expert.



LÚCID

Lúcid es una agencia de diseño que crea productos y experiencias centradas en el planeta y el usuario. Su misión es empoderar a las organizaciones para alcanzar la excelencia y distinción a través de estrategias de diseño global.

Lúcid is a design agency that creates planet and user-centric products and experiences. Their mission is to empower organizations to achieve excellence and distinction through global design strategies.



PABLO CASTILLO

Diseñador industrial independiente, formado en la universidad de Zaragoza y Elisava. Concibe el diseño como generador de impacto positivo.

Independent industrial designer, trained at the University of Zaragoza and Elisava. He conceives design as a generator of positive impact.



NIL CARBÓ

Diseñador, ilustrador y fotógrafo. Graduado en la Universidad de Barcelona. Basado en Berlín. También trabaja en el mundo de la moda.

Designer, illustrator and photographer. Graduated from the University of Barcelona. Based in Berlin. Also works in the fashion world.

BAHÍGÜELL

Agencia de diseño de producto independiente de Girona. Colaboradores estrechos de Comas y creadores de la gama de productos Caliu.

Independent product design agency from Girona. Close collaborators of Comas and creators of the Caliu product range.



Comas y la visión de nuestro chef

Contar con la experiencia de un chef profesional como Xavier Corominas permite a Comas estar verdaderamente cerca de las necesidades del sector.

Su conocimiento profundo de la cocina, la logística y el uso de utensilios nos ayuda a crear productos pensados para maximizar la funcionalidad en cada espacio culinario.

Comas and the vision of our chef

Having the experience of a professional chef like Xavier Corominas allows Comas to be truly close to the needs of the sector.

His in-depth knowledge of the kitchen, logistics and the use of utensils helps us to create products designed to maximise functionality in each culinary space.



La figura del chef en nuestro equipo nos aporta experiencia y refuerza el compromiso que tenemos de aprender continuamente de los profesionales que inspiran y guían nuestra innovación.

Estar al lado de quienes viven la cocina día a día es la clave de nuestro éxito y de nuestro vínculo con el mundo HORECA.

The figure of the chef in our team brings us experience and reinforces our commitment to continually learn from the professionals who inspire and guide our innovation.

Being at the side of those who live the kitchen on a daily basis is the key to our success and our link with the HORECA world.

Colaboradores: creciendo juntos

Creemos en las colaboraciones como motor de crecimiento. Nuestros colaboradores aportan una visión y experiencia que enriquecen nuestros productos, elevando el estándar de calidad y diseño.

Trabajar junto a ellos nos permite aprender, innovar y mantenernos a la vanguardia del sector.

Su pasión, experiencia y especialización son el valor añadido que nos diferencia.

UTSET
1894

Con 130 años de historia, Utset es una empresa dedicada a la fabricación, venta y afilado de cuchillos. Juntos creamos piezas únicas, de tradición artesana y experta, de forma industrial y al alcance de los creadores más exigentes.

With 130 years of history, Utset is a company dedicated to the manufacture, sale and sharpening of knives. Together we create unique pieces, with a tradition of craftsmanship and expertise, in an industrial way and within the reach of the most demanding creators.



Agencia de diseño de producto con amplia experiencia en el sector gastronómico. Juntos creamos productos modernos, atemporales y funcionales que elevan la experiencia gastronómica.

Product design agency with extensive experience in the gastronomic sector. Together we create modern, timeless and functional products that elevate the gastronomic experience.

L U E S M A  V E G A

Luesma & Vega es un estudio dedicado al diseño y producción de objetos artísticos en vidrio con técnicas contemporáneas que ha colaborado con diseñadores, decoradores y empresas, resolviendo sus necesidades.

Luesma & Vega is a studio dedicated to the design and production of artistic glass objects with contemporary techniques that has collaborated with designers, decorators and companies, solving their needs.



Empresa comercializadora y distribuidora de leña y carbón. Ubicada en Polinyà, Barcelona.

Company that sells and distributes firewood and charcoal. Located in Polinyà, Barcelona.

Partners: growing together

We believe in partnerships as an engine for growth. Our partners bring a vision and experience that enrich our products, raising the standard of quality and design.

Working with them allows us to learn, innovate and stay at the forefront of the industry.

Their passion, experience and specialisation are the added value that sets us apart.



Sede y capacidad

Estamos en Lliçà d'Amunt, disponemos de modernas instalaciones de 5.000 m² repartidas en 3 plantas, con un almacén en el que caben más de 10.000 palés.

Y estamos a sólo 30 km de Barcelona.

Headquarters and capacity

We are located in Lliçà d'Amunt, with modern facilities of 5,000 m² spread over 3 floors, with a warehouse that can hold more than 10,000 pallets.

And we are only at 30 km from Barcelona.

Showroom

Exposición de todos nuestros artículos para mostrar a las visitas de primera mano la calidad y acabados de los productos Comas.

Showroom

Exhibition of all our articles to show visitors firsthand the quality and finish of Comas products..

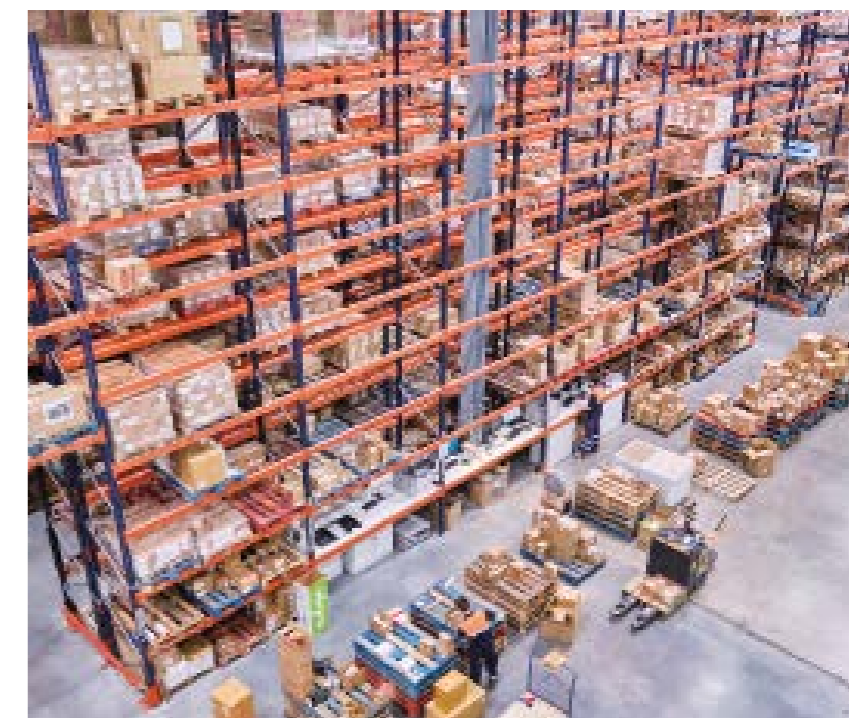
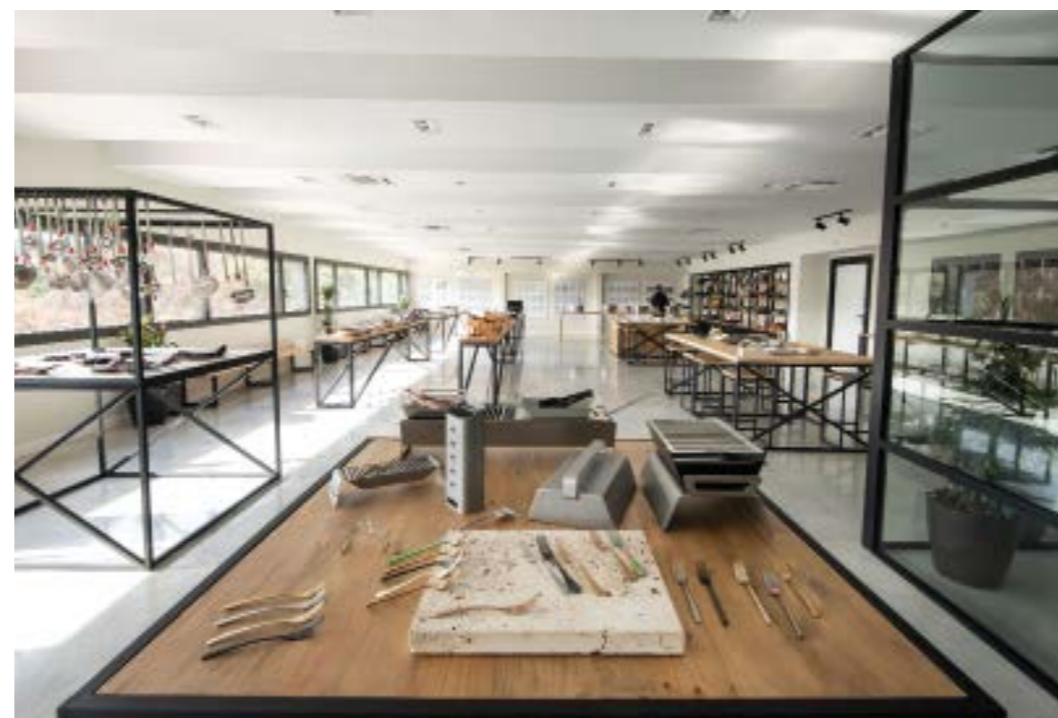

PRESENCIA / PRESENCE

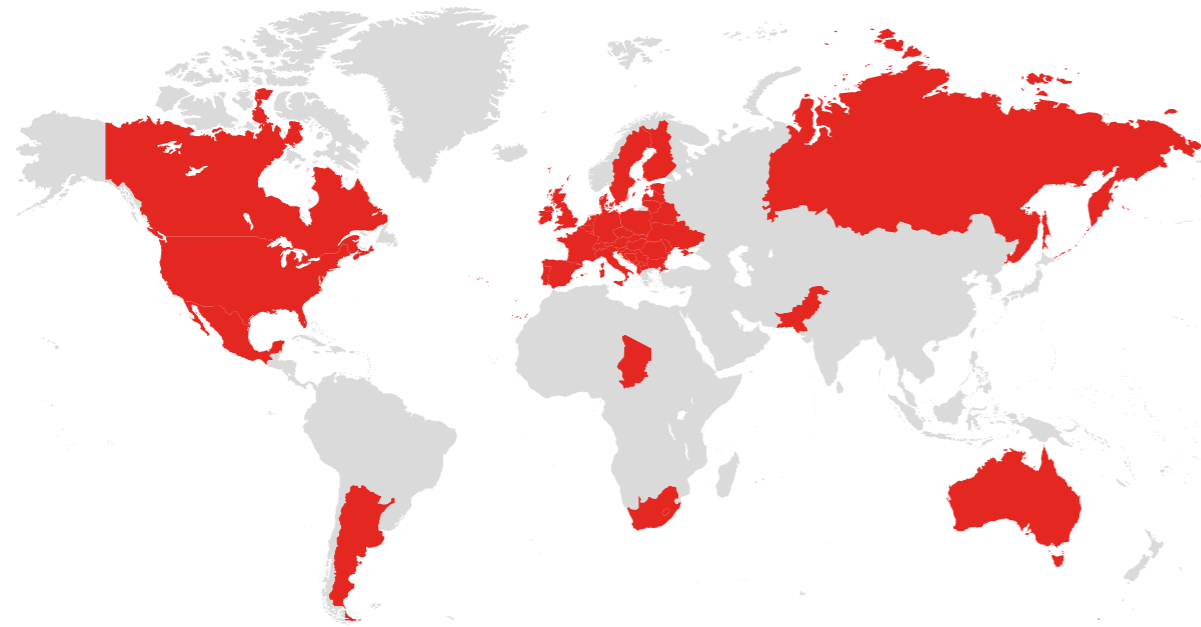

PRESENTES EN 57 PAÍSES / PRESENT IN 57 COUNTRIES

57

Germany, Belgium, Bulgaria, Burkina Faso, Cyprus, Croatia, Spain, United States of America, France, Greece, Hungary, Italy, Jordan, Lebanon, Lithuania, Luxembourg, Malta, Morocco, Mexico, Netherlands, Panama, Poland, Portugal, Andorra, U.K, Ireland, Slovakian, Rep., Dominican Rep., Reunion, Romania, Russia, Sweden, Tunisia, Ukraine, U.A.E, Austria, Chile, Denmark, Estonia, Georgia, Hong Kong, Iceland, Latvia, Moldova, Norway, Czech Republic, South Africa, Switzerland, Australia, Korea, Saudi Arabia, China, Peru, Finland, Kuwait, Sri Lanka.

CIFRAS / FIGURES

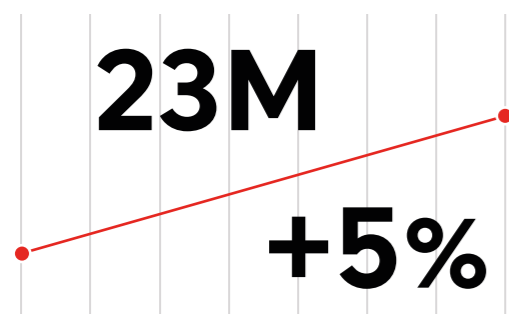

Previsión de crecimiento del 5% en 2024. EBITDA superior al 10%. Previsión de facturación de 23 M.

Expected growth of 5% in 2024. EBITDA of over 10%. Forecast turnover of 23 M.

MERCADOS: 45% EXPORTACIÓN
MARKETS: 45% EXPORT



45%
Internacional
International

55%
España
Spain

ALMACÉN / WAREHOUSE



8.250 m²

Almacén central de 5.000 m². Almacén en BCN con capacidad para 10.000 palés. Almacén en Canarias de 250 m². 2 almacenes en China de 3.000 m² (Guangzhou y Tianjin)

Central warehouse of 5,000 m². Warehouse in BCN with capacity for 10,000 pallets. Warehouse in the Canary Islands of 250 m². 2 warehouses in China of 3,000 m² (Guangzhou and Tianjin).

OFICINA EN CHINA
OFFICE IN CHINA



CHN

Nueva oficina en China (Guangzhou)
New office in China (Guangzhou)

60% STOCK SOBRE VENTAS
60% STOCK OVER SALES

60%



95% de pedidos servidos en máximo 48 horas.
95% of orders served in maximum 48 hours.



+1800 DISTRIBUIDORES
+1800 DISTRIBUTORS

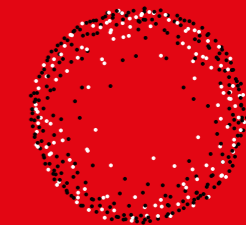

1.800

86 EMPLEADOS / EMPLOYEES

86

50 empleados internos
50 internal employees

36 comerciales externos
36 external sales staff



We are an inspiring
global partner for
professionals creators
at the back, front,
and core of the
hospitality industry.

CUBERTERÍA
CUTLERY



P. 24
INOX 18/10
INOX 18%
CHULETEROS

COCINA
KITCHEN



P. 216
CORTE
UTENSILIOS
PASTELERÍA
COCCIÓN
GASTRONORM

LOGISTICA
LOGISTICS



P. 334
RACKS
CONTENEDORES ISOTÉRMICOS

SALA
DINING ROOM



P. 352
VAJILLA
PRESENTACIÓN
MINIATURAS
SERVICIO MESA

BAR
BAR



P. 404
SERVICIO MESA
COCTELERÍA

BUFFET
BUFFET



P. 414
CAJAS MADERA
ACCESORIOS
ELEGANT
PINZAS

CATERING
CATERING



P. 436
AHUMADORES
LES ESSENCES

BRASA
GRILL



P. 464
CALIU
BRASA

CUBERTERÍA

CUTLERY



INOX 18/10

18/10 STAINLESS STEEL

- | | | | | | |
|-----|----------------------------|----|-----------------|-----|-------------------|
| 26 | ATLÁNTIDA | 63 | IRIS | 94 | NORTH XL |
| 100 | BAGUETTE S | 46 | KODAI VINTAGE | 93 | ONLINE |
| 98 | BAGUETTE XL | 48 | KODAI COLORS | 60 | OSLO |
| 108 | BARCELONA | 32 | LAB | 61 | OSLO OCEAN FREE |
| 64 | CALLAS | 38 | LAB ACCESSORIES | 69 | PALMA |
| 88 | CHEF | 34 | LAB COLORS | 44 | SAKURA |
| 70 | CONTOUR | 82 | LONDON | 65 | SANGIOVESE |
| 72 | CONTOUR COLORS | 84 | LONDON VINTAGE | 66 | SANGIOVESE COLORS |
| 62 | DALIA | 89 | LOTUS | 87 | TULIP |
| 56 | FLEUR DE LYS | 78 | MARANTA | 74 | VERSAILLES |
| 58 | FLEUR DE LYS VINTAGE BLACK | 80 | MARANTA VINTAGE | 75 | VERSAILLES COLORS |
| 92 | IBIZA | 52 | MINI KODAI | 106 | VIENA |
| 104 | INGLÉS M | 90 | MUNICH | 86 | VIOLET |
| 105 | INGLÉS S | 96 | NORTH M | | |
| 102 | INGLÉS XL | 97 | NORTH S | | |

INOX 18%

18% STAINLESS STEEL

- | | | | | | |
|-----|-----------------------|-----|-----------------|-----|-----------------|
| 172 | 1001 | 144 | CUBA | 142 | MADRID |
| 133 | 1001 BLACK | 173 | ECO | 120 | MALVARROSA |
| 174 | 1003 | 132 | FINGER FOOD | 146 | MIA |
| 162 | ALIDA | 156 | GRANADA S | 148 | NAPOLI |
| 116 | BCN COLORS | 154 | GRANADA XL | 175 | NERVIO |
| 114 | BCN SATIN | 140 | HIDRAULIC | 122 | NICE |
| 160 | BILBAO S | 141 | HIDRAULIC BLACK | 161 | OLYMPIA |
| 158 | BILBAO XL | 169 | HOTEL | 121 | OSLO ECO |
| 170 | BROOKLYN | 168 | HOTEL EXTRA ECO | 134 | SANTORINI |
| 124 | CANADA | 166 | HOTEL EXTRA M | 152 | SEVILLA S |
| 126 | CANADA VINTAGE | 165 | HOTEL EXTRA XL | 153 | SEVILLA VINTAGE |
| 127 | CANADA VINTAGE COLORS | 138 | KYOTO | 150 | SEVILLA XL |
| 139 | CHEESE | 137 | LOTUS FREE | 149 | VIEUX PARIS |
| 136 | CHEF FREE | 164 | LUNA | | |

OTROS

OTHERS

- | | |
|-----|-------------------------|
| 102 | ACTUALIZACIÓN / UPGRADE |
| 520 | FABRICACIÓN CUBIERTOS |
| 212 | FINISHES - PVD |
| 522 | MANTENIMIENTO CUBIERTOS |
| 110 | REPOSA CUBIERTOS |
| 171 | TAKE AWAY |



Descubre
las novedades
en cubertería.

Atlántida

Atlántida



Delta de Plata
Premios ADI 2022



El misterio de una experiencia gastronómica.
The mystery of a gastronomic experience..



Esta colección, diseñada de la mano de Nacar Design, rinde homenaje a los 30 años de experiencia de la empresa, y una vez más, transmite su misión de querer acompañar y realzar el día a día de los profesionales y comensales.

Las piezas destacan por su elegancia y minimalismo gracias a un discurso de líneas fluidas y el acabado sofisticado que le otorga el acero inoxidable texturizado.

This collection, designed by the hand of Nacar Design, pays tribute to the company's 30 years of heritage and expertise. And once again, communicates its desire of accompanying and enhancing the day-to-day life of professionals and diners.

The pieces stand out for their elegance and minimalism thanks to a discourse of fluid lines and the sophisticated finish given by textured stainless steel.

comas30
YEARS



**Conoce más
sobre Atlántida.**





ATLANTIDA CONCEPT
COMAS COLLECTION FAMILY
MESA - LUNCH - MOKA



ATLANTIDA MESA

ATLANTIDA LUNCH

MOKA

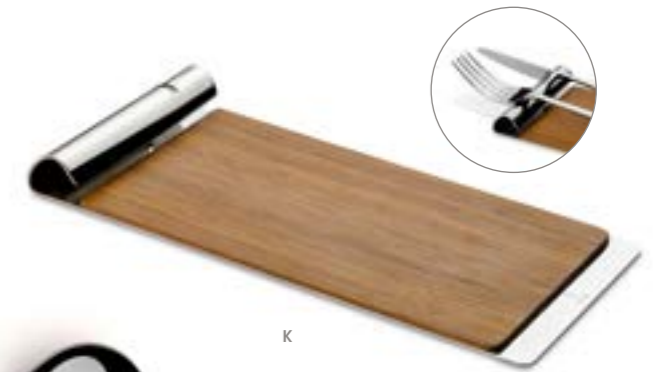

Everest + Atlántida

**BEST
COMBINATION**



INOX
STAINLESS
STEEL
304

- A **11582** CUCHILLO CHULETERO EVEREST
steak knife, couteau steak, coltello bistecca, steakmesser
- B **11583** TENEDOR CHULETERO EVEREST
steak knife, couteau steak, coltello bistecca, steakmesser
- C **8586** CUCHILLO MESA
table knife, couteau table, coltello tavola, tafelmesser
- D **8587** CUCHARA MESA
table spoon, cuillère table, cucchiaio tavola, tafellöffel
- E **8588** TENEDOR MESA
table fork, fourchette table, forchetta tavola, tafelgabel
- F **8656** CUCHARA SALSA
sauce spoon, cuillère a sauce, cucchiaio salsa, saucenlöffel
- G **8589** CUCHILLO LUNCH
cake knife, couteau gâteau, coltello dolce, kuchenmesser
- H **8591** CUCHARA LUNCH
cake spoon, cuillère gâteau, cucchiaio dolce, lunch löffel
- I **8590** TENEDOR LUNCH
cake fork, fourchette gâteau, forchetta dolce, kuchengabel
- J **8592** CUCHARA CAFÉ
coffee/moka spoon, cuillère moka, cucchiaio moka, mokkalöffel
- K **10431** REPOSA CUBIERTOS
cutlery holder, plateau à couverts, porta posate, schneidewagen

9773 24 PIEZAS
24 pieces, écin 24 pièces, bauletto 24 pz., 24 stück

UE	MOQ	▶ mm	✕ mm
0/6/60/540/2160	60	220	
0/6/60/540/2160	60	206	6
0/6/60/1920/5760	60	226	
0/6/60/1920/5760	60	215	6
0/6/60/1920/5760	60	218	6
0/6/60/1920/5760	60	216	6
0/6/60/1920/5760	60	169	
0/6/60/1920/5760	60	163	5
0/6/60/1920/5760	60	160	5
0/6/60/1920/5760	60	109	3,5
0/4/48	4	190	1,5
1/0/4	4		

Atlántida Ice Black

INOX 18/10 / 6mm / Ice Black



A B C D E F G H

INOX
STAINLESS
STEEL
304

- A **8579** CUCHILLO MESA
table knife, couteau table, coltello tavola, tafelmesser
- B **8580** CUCHARA MESA
table spoon, cuillère table, cucchiaio tavola, tafellöffel
- C **8581** TENEDOR MESA
table fork, fourchette table, forchetta tavola, tafelgabel
- D **8655** CUCHARA SALSA
sauce spoon, cuillère a sauce, cucchiaio salsa, saucenlöffel
- E **8582** CUCHILLO LUNCH
cake knife, couteau gâteau, coltello dolce, kuchenmesser
- F **8584** CUCHARA LUNCH
cake spoon, cuillère gâteau, cucchiaio dolce, lunch löffel
- G **8583** TENEDOR LUNCH
cake fork, fourchette gâteau, forchetta dolce, kuchengabel
- H **8585** CUCHARA CAFÉ
coffee/moka spoon, cuillère moka, cucchiaio moka, mokkalöffel

9772 24 PIEZAS
24 pieces, écin 24 pièces, bauletto 24 pz., 24 stück

UE	MOQ	▶ mm	✂ mm
0/6/60/1920/5760	60	226	
0/6/60/1920/5760	60	215	6
0/6/60/1920/5760	60	218	6
0/6/60/1920/5760	60	216	6
0/6/60/1920/5760	60	169	
0/6/60/1920/5760	60	163	5
0/6/60/1920/5760	60	160	5
0/6/60/1920/5760	60	109	3,5

1/0/4 4

NEW

Atlántida Polvo de Luna

INOX 18/10 / 6mm / Shotblasting



A B C D E F G H I J

Everest + Atlántida

BEST
COMBINATION

INOX
STAINLESS
STEEL
304

- A **10988** CUCHILLO CHULETERO EVEREST
steak knife, couteau steak, coltello bistecca, steakmesser
- B **10989** TENEDOR CHULETERO EVEREST
steak knife, couteau steak, coltello bistecca, steakmesser
- C **10979** CUCHILLO MESA
table knife, couteau table, coltello tavola, tafelmesser
- D **10981** CUCHARA MESA
table spoon, cuillère table, cucchiaio tavola, tafellöffel
- E **10980** TENEDOR MESA
table fork, fourchette table, forchetta tavola, tafelgabel
- F **10986** CUCHARA SALSA
sauce spoon, cuillère a sauce, cucchiaio salsa, saucenlöffel
- G **10982** CUCHILLO LUNCH
cake knife, couteau gâteau, coltello dolce, kuchenmesser
- H **10983** TENEDOR LUNCH
cake fork, fourchette gâteau, forchetta dolce, kuchengabel
- I **10984** CUCHARA LUNCH
cake spoon, cuillère gâteau, cucchiaio dolce, lunch löffel
- J **10985** CUCHARA CAFÉ
coffee/moka spoon, cuillère moka, cucchiaio moka, mokkalöffel

UE	MOQ	▶ mm	✂ mm
0/6/60/540/2160	60	220	
0/6/60/540/2160	60	206	6
0/6/60/1920/5760	60	226	
0/6/60/1920/5760	60	215	6
0/6/60/1920/5760	60	218	6
0/6/60/1920/5760	60	216	6
0/6/60/1920/5760	60	169	
0/6/60/1920/5760	60	163	5
0/6/60/1920/5760	60	160	5
0/6/60/1920/5760	60	109	3,5



INOX 18/10 / 2mm / Mirror



reddot design award
winner 2020

2020 WINNER
EUROPEAN
PRODUCT
DESIGN
AWARD

INOX
STAINLESS
STEEL
304



INOX 18/10 / 2mm / Mirror

	UE	MOQ	✦ mm	✦ mm
A 7890 CUCHILLO MESA MONOBLOC monoblock table knife, couteau table monobloc, coltello tavola monobloc, monoblock tafelmesser	0/12/120/1920/7680	60	160	
B 6976 CUCHILLO MESA table knife, couteau table, coltello tavola, tafelmesser	0/12/120/5400/10800	60	160	2,5
C 6977 TENEDOR MESA table fork, fourchette table, forchetta tavola, tafelgabel	0/12/120/5400/10800	60	154	2
D 6978 CUCHARA MESA table spoon, cuillère table, cucchiaio tavola, tafellöffel	0/12/120/5400/10800	60	153	2
E 6979 TENEDOR ARROZ rice fork, fourchette à riz, forchetta riso, reisgabel	0/12/120/5400/10800	60	148	2
F 6980 PINCHO cocktail stick, stick à cocktail, spiedo, spie	0/12/120/5400/16200	60	100	2
G 6981 PINCHO LARGO large cocktail stick, stick à cocktail long, spiedo lungo, langer spie	0/12/120/5400/16200	60	135	2
H 6982 TENEDOR APERITIVO appetizer fork, fourchette apéritif, forchetta antipasto, aperitif gabel	0/12/120/5400/16200	60	135	2
I 6983 CUCHARA APERITIVO appetizer spoon, cuillère apéritif, cucchiaio antipasto, aperitif löffel	0/12/120/5400/16200	60	135	2
J 6984 CUCHARA MOKA coffee/moka spoon, cuillère moka, cucchiaio moka, mokkalöffel	0/12/120/5400/16200	60	101	1,5
K 6985 CUCHARA LUNCH cake spoon, cuillère gâteau, cucchiaio dolce, lunch löffel	0/12/120/5400/16200	60	125	2
L 6986 TENEDOR LUNCH cake fork, fourchette gâteau, forchetta dolce, kuchengabel	0/12/120/5400/16200	60	125	2
M 7891 CUCHILLO LUNCH MONOBLOC monoblock cake knife, couteau gâteau monobloc, coltello dolce monobloc, monobloc kuchenmesser	0/12/120/1920/7680	60	135	
N 6987 CUCHILLO LUNCH cake knife, couteau gâteau, coltello dolce, kuchenmesser	0/12/120/5400/16200	60	135	
O 6988 CUCHARA COCTEL LARGA large cocktail, cuillère cocktail longue, cucchiaio cocktail lunga, cocktail löffel- lang	0/12/120/5400/10800	60	215	2
P 6989 CUCHARA CAFÉ ESPÁTULA spatula coffee spoon, cuillère spatule, cucchiaio spatola, kaffeelöffel	0/12/120/5400/16200	60	108	2
Q 6995 PINZA LARGA long tong, pince longue, molla lunga, lange zange	0/6/60/5400/10800	6	222	2
R 6996 PINZA CORTA short tong, pince courte, molla corta, kurze zange	0/6/60/5400/10800	6	160	2
S 6997 PINZA ESPÁTULA spatula tong, pince spatule, molla spatola, kochzange	0/6/60/5400/10800	6	160	2
T 6998 CUCHARA DEGUSTACIÓN tasting spoon, cuillère dégustation, cucchiaio degustazione, probierlöffel	0/6/60/5400/10800	6	86	2
V 6999 CUCHARA DEGUSTACIÓN OVAL oval tasting spoon, cuillère dégustation ovale, cucchiaio degustazione ovale, probierlöffel oval	0/6/60/5400/10800	6	101	2





INOX 18/10 / 2mm / Vintage Gold



**LAB
Collection.**

Lab Colors Vintage Gold

INOX 18/10 / 2mm / Vintage Gold



	UE	MOQ	▶ mm	✂ mm
A 1539 CUCHILLO MESA MONOBLOC monoblock table knife,couteau table monobloc, coltello tavola monobloc, monoblock tafelmesser	0/12/120/5400/10800	60	160	
B 1541 TENEDOR MESA table fork, fourchette table, forchetta tavola, tafelgabel	0/12/120/5400/10800	60	154	2
C 1540 CUCHARA MESA table spoon, cuillère table, cucchiaio tavola, tafellöffel	0/12/120/5400/10800	60	153	2
D 1542 TENEDOR ARROZ rice fork, fourchette à riz, forchetta riso, reisgabel	0/12/120/5400/10800	60	148	2
E 1543 PINCHO cocktail stick, stick à cocktail, spiedo, spie	0/12/120/5400/10800	60	100	2
F 1544 PINCHO LARGO large cocktail stick, stick à cocktail long, spiedo lungo, langer spie	0/12/120/5400/10800	60	135	2
G 1545 TENEDOR APERITIVO appetizer fork, fourchette apéritif, forchetta antipasto, aperitif gabel	0/12/120/5400/10800	60	135	2
H 1546 CUCHARA APERITIVO appetizer spoon, cuillère apéritif, cucchiaio antipasto, aperitif löffel	0/12/120/5400/10800	60	135	2
I 1547 CUCHARA MOKA coffee/moka spoon, cuillère moka, cucchiaio moka, mokkalöffel	0/12/120/5400/10800	60	101	1,5
J 1549 CUCHARA LUNCH cake spoon, cuillère gâteau, cucchiaio dolce, lunch löffel	0/12/120/5400/10800	60	125	2
K 1550 TENEDOR LUNCH cake fork, fourchette gâteau, forchetta dolce, kuchengabel	0/12/120/5400/10800	60	125	2
L 1548 CUCHILLO LUNCH MONOBLOC monoblock cake knife, couteau gâteau monobloc, coltello dolce monobloc, monobloc kuchenmesser	0/12/120/5400/10800	60	135	
M 1551 CUCHARA COCTEL LARGA large cocktail, cuillère cocktail longue, cucchiaio cocktail lunga, cocktail löffel- lang	0/12/120/5400/10800	60	215	2
N 1552 CUCHARA CAFÉ ESPÁTULA spatula coffee spoon, cuillère spatule, cucchiaio spatola, mokkalöffel	0/12/120/5400/10800	60	108	2
O 1553 CUCHARA DEGUSTACIÓN tasting spoon, cuillère dégustation, cucchiaio degustazione, probierlöffel	0/12/120/5400/10800	60	86	2
P 1554 CUCHARA DEGUSTACIÓN OVAL oval tasting spoon, cuillère dégustation ovale, cucchiaio degustazione ovale, probierlöffel oval	0/12/120/5400/10800	60	101	2

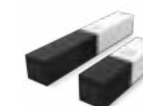

Lab Colors Vintage Copper

INOX 18/10 / 2mm / Vintage Copper





Lab Colors Ice Black



INOX 18/10 / 2mm / Ice Black



INOX
STAINLESS
STEEL
304

		UE	MOQ	▶ mm	✂ mm	
A	1555 CUCHILLO MESA MONOBLOC monoblock table knife, couteau table monobloc, coltello tavola monobloc, monoblock tafelmesser	0/12/120/5400/10800	60	160		
B	1557 TENEDOR MESA table fork, fourchette table, forchetta tavola, tafelgabel,	0/12/120/5400/10800	60	154	2	
C	1556 CUCHARA MESA table spoon, cuillère table, cucchiaio tavola, tafellöffel	0/12/120/5400/10800	60	153	2	
D	1558 TENEDOR ARROZ rice fork, fourchette à riz, forchetta riso, reispabel	0/12/120/5400/10800	60	148	2	
E	1559 PINCHO cocktail stick, stick à cocktail, spiedo, spie	0/12/120/5400/10800	60	100	2	
F	1560 PINCHO LARGO large cocktail stick, stick à cocktail long, spiedo lungo, langer spie	0/12/120/5400/10800	60	135	2	
G	1561 TENEDOR APERITIVO appetizer fork, fourchette apéritif, forchetta antipasto, aperitif gabel	0/12/120/5400/10800	60	135	2	
H	1562 CUCHARA APERITIVO appetizer spoon, cuillère apéritif, cucchiaio antipasto, aperitif löffel	0/12/120/5400/10800	60	135	2	
I	1563 CUCHARA MOKA coffee/moka spoon, cuillère moka, cucchiaio moka, mokkalöffel	0/12/120/5400/10800	60	101	1,5	
J	1565 CUCHARA LUNCH cake spoon, cuillère gâteau, cucchiaio dolce, lunch löffel	0/12/120/5400/10800	60	125	2	
K	1566 TENEDOR LUNCH cake fork, fourchette gâteau, forchetta dolce, kuchengabel	0/12/120/5400/10800	60	125	2	
L	1564 CUCHILLO LUNCH MONOBLOC monoblock cake knife, couteau gâteau monobloc, coltello dolce monobloc, monobloc kuchenmesser	0/12/120/5400/10800	60	135		
M	1567 CUCHARA COCTEL LARGA large cocktail, cuillère cocktail longue, cucchiaio cocktail lunga, cocktail löffel- lang	0/12/120/5400/10800	60	215	2	
N	1568 CUCHARA CAFÉ ESPÁTULA spatula coffee spoon, cuillère spatule, cucchiaio spatola, mokkalöffel	0/12/120/5400/10800	60	108	2	
O	1569 CUCHARA DEGUSTACIÓN tasting spoon, cuillère dégustation, cucchiaio degustazione, probierlöffel	0/12/120/5400/10800	60	86	2	
P	1570 CUCHARA DEGUSTACIÓN OVAL oval tasting spoon, cuillère dégustation ovale, cucchiaio degustazione ovale, probierlöffel oval	0/12/120/5400/10800	60	101	2	

INOX
STAINLESS
STEEL
304

		UE	MOQ	▶ mm	✂ mm	
A	8640 CUCHILLO MESA MONOBLOC monoblock table knife, couteau table monobloc, coltello tavola monobloc, monoblock tafelmesser	0/12/120/5400/10800	60	160		
B	7665 TENEDOR MESA table fork, fourchette table, forchetta tavola, tafelgabel,	0/12/120/5400/10800	60	154	2	
C	8641 CUCHARA MESA table spoon, cuillère table, cucchiaio tavola, tafellöffel	0/12/120/5400/10800	60	153	2	
D	8642 TENEDOR ARROZ rice fork, fourchette à riz, forchetta riso, reispabel	0/12/120/5400/10800	60	148	2	
E	8643 PINCHO cocktail stick, stick à cocktail, spiedo, spie	0/12/120/5400/10800	60	100	2	
F	8644 PINCHO LARGO large cocktail stick, stick à cocktail long, spiedo lungo, langer spie	0/12/120/5400/10800	60	135	2	
G	8645 TENEDOR APERITIVO appetizer fork, fourchette apéritif, forchetta antipasto, aperitif gabel	0/12/120/5400/10800	60	135	2	
H	8646 CUCHARA APERITIVO appetizer spoon, cuillère apéritif, cucchiaio antipasto, aperitif löffel	0/12/120/5400/10800	60	135	2	
I	8647 CUCHARA MOKA coffee/moka spoon, cuillère moka, cucchiaio moka, mokkalöffel	0/12/120/5400/10800	60	101	1,5	
J	8649 CUCHARA LUNCH cake spoon, cuillère gâteau, cucchiaio dolce, lunch löffel	0/12/120/5400/10800	60	125	2	
K	8650 TENEDOR LUNCH cake fork, fourchette gâteau, forchetta dolce, kuchengabel	0/12/120/5400/10800	60	125	2	
L	8648 CUCHILLO LUNCH MONOBLOC monoblock cake knife, couteau gâteau monobloc, coltello dolce monobloc, monobloc kuchenmesser	0/12/120/5400/10800	60	135		
M	8651 CUCHARA COCTEL LARGA large cocktail, cuillère cocktail longue, cucchiaio cocktail lunga, cocktail löffel- lang	0/12/120/5400/10800	60	215	2	
N	8652 CUCHARA CAFÉ ESPÁTULA spatula coffee spoon, cuillère spatule, cucchiaio spatola, mokkalöffel	0/12/120/5400/10800	60	108	2	
O	8653 CUCHARA DEGUSTACIÓN tasting spoon, cuillère dégustation, cucchiaio degustazione, probierlöffel	0/12/120/5400/10800	60	86	2	
P	8654 CUCHARA DEGUSTACIÓN OVAL oval tasting spoon, cuillère dégustation ovale, cucchiaio degustazione ovale, probierlöffel oval	0/12/120/5400/10800	60	101	2	

Lab Accessories



reddot design award
winner 2021

Lab Accessories

Servicio mesa / Table top



Comas presenta la nueva colección LAB ACCESSORIES. Un conjunto de platos y bases para servir, en diferentes materiales y colores que junto a la ya existente cubertería de Culter, te permitirá completar la experiencia de degustar aperitivos, tapas y arroces.

Todos los elementos de la colección siguen las mismas proporciones, ayudándote a crear múltiples composiciones, jugando con la modularidad y la combinación de colores, materiales y texturas.

Comas introduces its new LAB ACCESSORIES collection. A collection of dishes and serving platters in different materials and colours that goes perfectly with Culter's existing serving ware for you to make the experience of savouring canapés, tapas and rice dishes complete.

All the items in the collection are in the same proportions, so that you can create different compositions by exploiting their modularity and the combinations of colours, materials and textures.



Descubre la modularidad de LAB.





Lab Accessories

Servicio mesa / Table Top

Plato 1/4 ración redondo
1/4 ration circle plate
plateau 1/4 bassin rond
vassoio 1/4 porzione rotonda
1/4 portion quadratischer edelstahl teller



REF.	W(mm)	L(mm)	€	UE / MOQ
8000	92,5	92,5		0-4-16-864-2592 / 4

Plato 1/4 ración redondo doble
1/2 ration circle double plate
plateau 1/4 double bassin rond
vassoio 1/4 porzione doppia
1/4 portion rechteckiger edelstahl teller doppelt



REF.	W(mm)	L(mm)	€	UE / MOQ
8004	92,5	185		0-4-16-480-1920 / 4

Plato 1 ración oval
1 ration oval plate
plateau 1 bassin ovale
vassoio 1 porzione ovale
1 portion rechteckiger edelstahl teller



REF.	W(mm)	L(mm)	€	UE / MOQ
8005	92,5	278		0-4-16-288-864 / 4

Plato 1 ración redondo
1 ration circle plate
plateau 1 bassin rond
vassoio 1 porzione rotonda
1 portion quadratischer edelstahl teller



REF.	W(mm)	L(mm)	€	UE / MOQ
8002	185	185		0-4-16-240-1200 / 4

Plato 1/2 ración oval
1/2 ration oval plate
plateau 1/2 bassin ovale
vassoio 1/2 porzione ovale
ovale 1/2 portion rechteckiger edelstahl teller



REF.	W(mm)	L(mm)	€	UE / MOQ
8003	92,5	185		0-4-16-480-1920 / 4

Plato 1/2 ración oval + pinchos
1/2 ration oval plate + stick holder
plateau 1/2 bassin ovale + porte brochette
vassoio 1/2 porzione ovale + fori spiedini
1/2 portion rechteckiger edelstahl teller mit spießhalter



REF.	W(mm)	L(mm)	€	UE / MOQ
8006	92,5	278		0-4-16-352-1408 / 4

BAJO DEMANDA
ON DEMAND

Plato 1 ración redondo PVD
PVD 1 ration circle plate
plateau bassin rond PVD
vassoio 1 porzione rotonda PVD
PVD 1 portion quadratischer edelstahl teller



ACABADO
ICE
ICE FINISH

REF.	COLOR	W(mm)	L(mm)	€	UE / MOQ
8604	ORO	185	185		0-4-16-240-720 / 4
8605	COBRE	185	185		0-4-16-240-720 / 4
8606	NEGRO	185	185		0-4-16-240-720 / 4

BAJO DEMANDA
ON DEMAND

Plato 1/2 ración oval PVD
PVD 1/2 ration oval plate
plateau 1/2 bassin ovale PVD
vassoio 1/2 porzione ovale PVD
PVD ovale 1/2 portion rechteckiger edelstahl teller



ACABADO
ICE
ICE FINISH

REF.	COLOR	W(mm)	L(mm)	€	UE / MOQ
8607	ORO	92,5	185		0-4-16-288-864 / 4
8608	COBRE	92,5	185		0-4-16-288-864 / 4
8609	NEGRO	92,5	185		0-4-16-288-864 / 4

Base porcelana pequeña
Small porcelain tray
Petit plateau en porcelaine
Vassoio piccolo porcellana
Porzellantablett klein

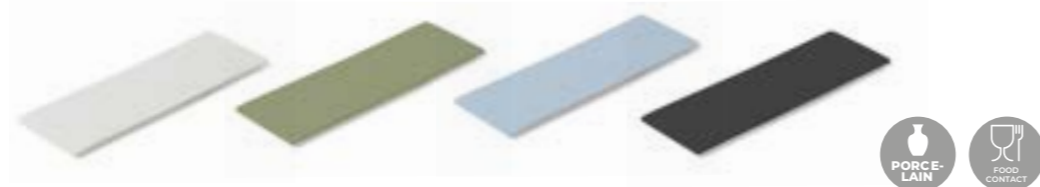

REF.	COLOR	W(mm)	L(mm)	€	UE / MOQ
8598	BLANCO	92,5	278		0-4-16-192-960 / 4
8600	VERDE	92,5	278		0-4-16-192-960 / 4
8602	AZUL	92,5	278		0-4-16-192-960 / 4
8596	NEGRO	92,5	278		0-4-16-192-960 / 4

Base porcelana grande
Double porcelain tray
Plateau en porcelaine double
Vassoio porcellana doppio
Doppeltes porzellantablett

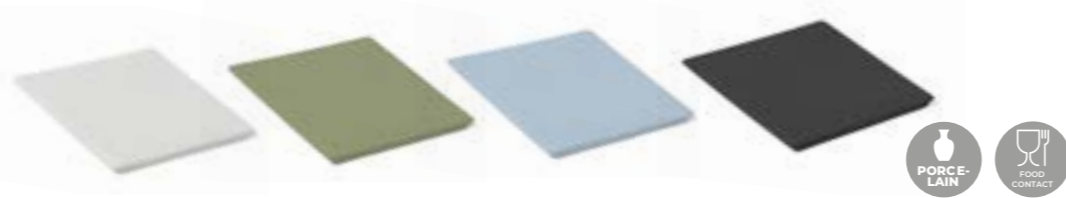

REF.	COLOR	W(mm)	L(mm)	€	UE / MOQ
8599	BLANCO	185	185		0-4-16-240-720 / 4
8601	VERDE	185	185		0-4-16-240-720 / 4
8603	AZUL	185	185		0-4-16-240-720 / 4
8597	NEGRO	185	185		0-4-16-240-720 / 4

Base madera
Wood tray
Plateau en bois
Vassoio legno
Holztablett



REF.	SIZE	W(mm)	L(mm)	€	UE / MOQ
8370	SIMPLE	92,5	278		0-4-16-208-1040 / 4
8371	DOBLE	185	278		0-4-16-208-624 / 4

Disco pinchos
Round stick holder
Orte brochette rond
Disco fori spiedini
Runder edelstahl spießhalter



REF.	Ø(mm)	H(mm)	Para ref. / For ref.	€	UE / MOQ
8001	71	35	8000 - 8004		0-4-16-736-1472 / 4

Plato gest M
Gest plate M
Plateau en porcelaine gest M
Vassoio pocellana gest M
Gest porzellantablett M



REF.	SIZE	H(mm)	W(mm)	L(mm)	€	UE / MOQ
9984	S	30	110	105		0-4-16-512-1536 / 4
11808	M	30	145	200		0-4-48-0-0 / 4

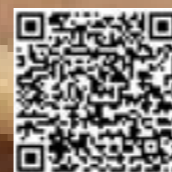

Conoce más sobre
LAB Accesories.



SAKURA
Collection.



reddot design award
winner 2020



INOX 18/10 / 5mm / Mirror



- | | | |
|---|-------------|--|
| A | 6931 | CUCHILLO MESA
table knife, couteau table, coltello tavola, tafelmesser |
| B | 6932 | CUCHARA MESA
table spoon, cuillère table, cucchiaio tavola, tafellöffel |
| C | 6933 | TENEDOR MESA
table fork, fourchette table, forchetta tavola, tafelgabel |
| D | 6934 | CUCHARA RAMEN
ramen spoon, cuillère ramen, cucchiaio ramen, ramen löffel |
| E | 6935 | SET PALILLOS
chopsticks set, set piques, set bacchette, e_stäbchen- set |
| F | 6936 | PLATO PALILLOS PORCELANA
porcelain chopsticks plate, porcelaine assiette piques, piatto porcellana bacchette, e_stäbchen- teller porzellan |
| G | 7869 | SOPORTE CUBIERTOS
cutlery holder, panier à couverts, supporto coperte, besteckhalter |
| H | 6939 | TENEDOR LUNCH
cake fork, fourchette gâteau, forchetta dolce, kuchengabel |
| I | 6940 | CUCHARA CAFÉ
tea spoon, cuillère café, cucchiaio caffè, kaffeelöffel |
| J | 6941 | CUCHARA MOKA
coffee/moka spoon, cuillère moka, cucchiaio moka, mokkalöffel |
| K | 9789 | 24 PIEZAS
24 pieces, écriin 24 pièces, bauletto 24 pz., 24 stück |

UE	MOQ	▶ mm	✕ mm
0/6/60/1440/4320	60	228	
0/6/60/1440/4320	60	206	5
0/6/60/1440/4320	60	210	5
0/6/60/1440/4320	60	192	5
0/6/60/1440/4320	60	230	5,5
0/6/60/1440/4320	60		
0/6/60/1440/4320	60	80	8,5
0/6/60/1440/4320	60	151	3,5
0/6/60/1440/4320	60	147	3
0/6/60/1440/4320	60	105	2
1/0/4	4		5





INOX 18% Nickel Free / 3mm / Vintage



KODAI
Collection.

2019 WINNER
EUROPEAN
PRODUCT
DESIGN
AWARD

INOX
STAINLESS
STEEL
430

Kodai Vintage

INOX 18% Nickel Free / 3mm / Vintage



- A **7276** CUCHILLO MESA XL
table knife xl vintage, couteau table xl vintage, coltello tavola xl vintage, tafelmesser xl vintage
- B **7279** CUCHARA MESA XL
table spoon xl vintage, cuillère table xl vintage, cucchiaio tavola xl vintage, tafelöffel xl vintage
- C **7285** TENEDOR MESA 3 PUAS XL
table fork 3 prongs xl vintage, fourchette table xl 3 dents vintage, forchetta tavola xl 3 punte vintage, tafelgabel xl vintage

- D **6943** CUCHILLO MESA
vintage table knife, couteau table vintage, coltello tavola vintage, tafelmesser vintage
- E **6944** CUCHARA MESA
vintage table spoon, cuillère table vintage, cucchiaio tavola vintage, tafelöffel vintage
- F **6945** TENEDOR MESA 2 PUAS
vintage table fork 2 prongs, fourchette table 2 dents vintage, forchetta tavola 2 punte, tafelgabel 2
- G **6946** TENEDOR MESA 3 PUAS
vintage table fork 3 prongs, fourchette table 3 dents vintage, forchetta tavola 3 punte, tafelgabel 3
- H **6947** CUCHILLO MANTEQUILLA
vintage butter knife, couteau beurre, coltello burro, buttermesser

- I **6948** CUCHILLO LUNCH
vintage cake knife, couteau gâteau, coltello dolce, kuchenmesser
- J **6949** TENEDOR LUNCH
vintage cake fork, fourchette gâteau, forchetta dolce, kuchengabel
- K **6950** CUCHARA CAFÉ
vintage coffee spoon, cuillère café, cucchiaio caffè, kaffeelöffel
- L **6951** CUCHARA SIDE
vintage side spoon, cuillère side, cucchiaio side, löffel side
- M **6952** CUCHARA MOKA
vintage moka spoon, cuillère moka, cucchiaio moka, mokkalöffel
- N **6953** CUCHARA ARROZ
vintage rice spoon, cuillère à riz, cucchiaio riso, reisilöffel
- O **6954** TENEDOR RASTRILLO
vintage wide fork, fourchette râteau, forchetta wide, tafelgabel wide

- 9791** 24 PIEZAS
24 pièces, écriin 24 pièces, bauletto 24 pz, 24 stück

	UE	MOQ	▶ mm	✂ mm
A	0/12/120/2880/5760	60	212	
B	0/12/120/2880/5760	60	190	3
C	0/12/120/2880/5760	60	195	3
D	0/12/120/1800/9000	60	183	
E	0/12/120/1800/9000	60	170	2,5
F	0/12/120/1800/9000	60	179	2,5
G	0/12/120/1800/9000	60	163	2,5
H	0/12/120/1800/9000	60	155	
I	0/12/120/1800/9000	60	133	
J	0/12/120/1800/9000	60	138	2
K	0/12/120/1800/9000	60	115,4	1,7
L	0/12/120/1800/9000	60	93,5	2
M	0/12/120/1800/9000	60	97,5	1,7
N	0/12/120/1680/6720	60	90	2,5
O	0/12/120/1680/6720	60	113	2,5
	1/0/4	4		3





INOX
STAINLESS
STEEL
430

- A **7278** CUCHILLO MESA XL
table knife xl vintage, couteau table xl vintage, coltello tavola xl vintage, tafelmesser xl vintage
- B **7281** CUCHARA MESA XL
table spoon xl vintage, cuillère table xl vintage, cucchiaio tavola xl vintage, tafellöffel xl vintage
- C **7287** TENEDOR MESA 3 PUAS XL
table fork 3 prongs xl vintage, fourchette table xl 3 dents vintage, forchetta tavola xl 3 punte vintage, tafelgabel xl vintage

UE MOQ ▶ mm ✕ mm

- D **7081** CUCHILLO MESA
vintage table knife, couteau table vintage, coltello tavola vintage, tafelmesser vintage
- E **7082** CUCHARA MESA
vintage table spoon, cuillère table vintage, cucchiaio tavola vintage, tafellöffel vintage
- F **7083** TENEDOR MESA 2 PUAS
vintage table fork 2 prongs, fourchette table 2 dents vintage, forchetta tavola 2 punte, tafelgabel 2
- G **7084** TENEDOR MESA 3 PUAS
vintage table fork 3 prongs, fourchette table 3 dents vintage, forchetta tavola 3 punte, tafelgabel 3
- H **7085** CUCHILLO MANTEQUILLA
vintage butter knife, couteau beurre, coltello burro, buttermesser
- I **7086** CUCHILLO LUNCH
vintage cake knife, couteau gâteau, coltello dolce, kuchenmesser
- J **7087** TENEDOR LUNCH
vintage cake fork, fourchette gâteau, forchetta dolce, kuchengabel
- K **7088** CUCHARA CAFÉ
vintage coffee spoon, cuillère café, cucchiaio caffè, kaffeelöffel
- L **7089** CUCHARA SIDE
vintage side spoon, cuillère side, cucchiaio side, löffel side
- M **7090** CUCHARA MOKA
vintage moka spoon, cuillère moka, cucchiaio moka, mokkalöffel
- N **7091** CUCHARA ARROZ
vintage rice spoon, cuillère à riz, cucchiaio riso, reislöffel
- O **7092** TENEDOR RASTRILLO
vintage wide fork, fourchette râteau, forchetta wide, tafelgabel wide

UE	MOQ	▶ mm	✕ mm
0/12/120/2880/5760	60	212	
0/12/120/2880/5760	60	190	3
0/12/120/2880/5760	60	195	3
0/12/120/1800/9000	60	183	
0/12/120/1800/9000	60	170	2,5
0/12/120/1800/9000	60	179	2,5
0/12/120/1800/9000	60	163	2,5
0/12/120/1800/9000	60	155	
0/12/120/1800/9000	60	133	
0/12/120/1800/9000	60	138	2
0/12/120/1800/9000	60	115,4	1,7
0/12/120/1800/9000	60	93,5	2
0/12/120/1800/9000	60	97,5	1,7
0/12/120/1680/6720	60	90	2,5
0/12/120/1680/6720	60	113	2,5

- 9793** 24 PIEZAS
24 pieces, écrin 24 pièces, bauletto 24 pz., 24 stück

1/0/4	4	3
-------	---	---

INOX 18% Nickel Free / 3mm / Vintage Gold



Kodai Vintage Copper

INOX 18% Nickel Free / 3mm / Vintage Copper



		UE	MOQ	▶ mm	✂ mm	
A	4929 CUCHILLO MESA XL table knife xl vintage, couteau table xl vintage, coltello tavola xl vintage, tafelmesser xl vintage	0/12/120/2880/5760	60	212		
B	4930 CUCHARA MESA XL table spoon xl vintage, cuillère table xl vintage, cucchiaio tavola xl vintage, tafellöffel xl vintage	0/12/120/2880/5760	60	190	3	
C	4931 TENEDOR MESA 3 PUAS XL table fork 3 prongs xl vintage, fourchette table xl 3 dents vintage, forchetta tavola xl 3 punte vintage, tafelgabel xl vintage	0/12/120/2880/5760	60	195	3	
D	4932 CUCHILLO MESA vintage table knife, couteau table vintage, coltello tavola vintage, tafelmesser vintage	0/12/120/1800/9000	60	183		
E	4933 CUCHARA MESA vintage table spoon, cuillère table vintage, cucchiaio tavola vintage, tafellöffel vintage	0/12/120/1800/9000	60	170	2,5	
F	4934 TENEDOR MESA 2 PUAS vintage table fork 2 prongs, fourchette table 2 dents vintage, forchetta tavola 2 punte, tafelgabel 2	0/12/120/1800/9000	60	179	2,5	
G	4935 TENEDOR MESA 3 PUAS vintage table fork 3 prongs, fourchette table 3 dents vintage, forchetta tavola 3 punte, tafelgabel 3	0/12/120/1800/9000	60	163	2,5	
H	4936 CUCHILLO MANTEQUILLA vintage butter knife, couteau beurre, coltello burro, buttermesser	0/12/120/1800/9000	60	155		
I	4937 CUCHILLO LUNCH vintage cake knife, couteau gâteau, coltello dolce, kuchenmesser	0/12/120/1800/9000	60	133		
J	4938 TENEDOR LUNCH vintage cake fork, fourchette gâteau, forchetta dolce, kuchengabel	0/12/120/1800/9000	60	138	2	
K	4939 CUCHARA CAFÉ vintage coffee spoon, cuillère café, cucchiaio caffè, kaffeelöffel	0/12/120/1800/9000	60	115,4	1,7	
L	4940 CUCHARA SIDE vintage side spoon, cuillère side, cucchiaio side, löffel side	0/12/120/1800/9000	60	93,5	2	
M	4941 CUCHARA MOKA vintage moka spoon, cuillère moka, cucchiaio moka, mokkalöffel	0/12/120/1800/9000	60	97,5	1,7	
N	4942 CUCHARA ARROZ vintage rice spoon, cuillère à riz, cucchiaio riso, reislöffel	0/12/120/1680/6720	60	90	2,5	
O	4943 TENEDOR RASTRILLO vintage wide fork, fourchette râteau, forchetta wide, taffelgabel wide	0/12/120/1680/6720	60	113	2,5	
4945	24 PIEZAS 24 pieces, écrin 24 pièces, bauletto 24 pz., 24 stück	1/0/4	4		3	

Kodai Vintage Black

INOX 18% Nickel Free / 3mm / Vintage Black



		UE	MOQ	▶ mm	✂ mm	
A	7277 CUCHILLO MESA XL table knife xl vintage, couteau table xl vintage, coltello tavola xl vintage, tafelmesser xl vintage	0/12/120/2880/5760	60	212		
B	7280 CUCHARA MESA XL table spoon xl vintage, cuillère table xl vintage, cucchiaio tavola xl vintage, tafellöffel xl vintage	0/12/120/2880/5760	60	190	3	
C	7286 TENEDOR MESA 3 PUAS XL table fork 3 prongs xl vintage, fourchette table xl 3 dents vintage, forchetta tavola xl 3 punte vintage, tafelgabel xl vintage	0/12/120/2880/5760	60	195	3	
D	7069 CUCHILLO MESA vintage table knife, couteau table vintage, coltello tavola vintage, tafelmesser vintage	0/12/120/1800/9000	60	183		
E	7070 CUCHARA MESA vintage table spoon, cuillère table vintage, cucchiaio tavola vintage, tafellöffel vintage	0/12/120/1800/9000	60	170	2,5	
F	7071 TENEDOR MESA 2 PUAS vintage table fork 2 prongs, fourchette table 2 dents vintage, forchetta tavola 2 punte, tafelgabel 2	0/12/120/1800/9000	60	179	2,5	
G	7072 TENEDOR MESA 3 PUAS vintage table fork 3 prongs, fourchette table 3 dents vintage, forchetta tavola 3 punte, tafelgabel 3	0/12/120/1800/9000	60	163	2,5	
H	7073 CUCHILLO MANTEQUILLA vintage butter knife, couteau beurre, coltello burro, buttermesser	0/12/120/1800/9000	60	155		
I	7074 CUCHILLO LUNCH vintage cake knife, couteau gâteau, coltello dolce, kuchenmesser	0/12/120/1800/9000	60	133		
J	7075 TENEDOR LUNCH vintage cake fork, fourchette gâteau, forchetta dolce, kuchengabel	0/12/120/1800/9000	60	138	2	
K	7076 CUCHARA CAFÉ vintage coffee spoon, cuillère café, cucchiaio caffè, kaffeelöffel	0/12/120/1800/9000	60	115,4	1,7	
L	7077 CUCHARA SIDE vintage side spoon, cuillère side, cucchiaio side, löffel side	0/12/120/1800/9000	60	93,5	2	
M	7078 CUCHARA MOKA vintage moka spoon, cuillère moka, cucchiaio moka, mokkalöffel	0/12/120/1800/9000	60	97,5	1,7	
N	7079 CUCHARA ARROZ vintage rice spoon, cuillère à riz, cucchiaio riso, reislöffel	0/12/120/1680/6720	60	90	2,5	
O	7080 TENEDOR RASTRILLO vintage wide fork, fourchette râteau, forchetta wide, taffelgabel wide	0/12/120/1680/6720	60	113	2,5	
9795	24 PIEZAS 24 pieces, écrin 24 pièces, bauletto 24 pz., 24 stück	1/0/4	4		3	

Mini Kodai

Mini Kodai
Servicio mesa / Table top



Gama de miniaturas pensada en combinar la colección Kodai para crear el conjunto perfecto en la mesa y disfrutar de una experiencia completa al degustar un aperitivo o unas tapas.

Miniatures range designed to combine Kodai collection and create a perfect set on a table and enjoy a complete experience on tasting a snack or "tapas".





Mini Kodai

Servicio mesa / Table Top



Mini vaso
Mini cup
Mini verre
Mini vaso
Dipschälchen klein



REF.	Ø(mm)	H(mm)	ml	€	UE / MOQ
7625	50	40	2,5		1-6-144-2592-2592 / 6

Mini tarrina
Mini ramekin
Mini pôt
Mini terrina
Dipschälchen groß



REF.	Ø(mm)	H(mm)	€	UE / MOQ
7626	80	25		1-6-144-1728-1728 / 6

Mini sartén
Mini pan
Mini poêle
Mini padella
Mini pfanne



REF.	Ø(mm)	L(mm)	H(mm)	€	UE / MOQ
7627	90	140	22		1-6-72-360-1080 / 6

Mini bandeja
Mini tray
Mini plateau
Mini vassoio
Mini platte



REF.	W(mm)	L(mm)	H(mm)	€	UE / MOQ
7629	80	155	10		1-6-72-360-1080 / 6

Mini caja M
Mini box M
Mini Boîte M
Mini Cassetta M
Behälter M



REF.	W(mm)	L(mm)	H(mm)	€	UE / MOQ
7621	80	120	70		1-6-36-360-1080 / 6

Mini parrilla
Mini grill plate
Mini grill
Mini graticola
Mini gratin platte



REF.	Ø(mm)	L(mm)	H(mm)	€	UE / MOQ
7624	90	125	20		1-6-144-1728-1728 / 6

Mini cazuela
Mini casserole
Mini casserole
Mini casseruola
Mini kasserolle



REF.	Ø(mm)	L(mm)	H(mm)	€	UE / MOQ
7628	90	130	25		1-6-72-360-1080 / 6

Mini olla
Mini pot
Mini-pot
Mini pentola
Mini topf



REF.	Ø(mm)	L(mm)	H(mm)	ml	€	UE / MOQ
7630	100	140	90	250		1-6-36-360-1080 / 6

Fleur de Lys



INOX 18/10 / 4,5mm / Mirror

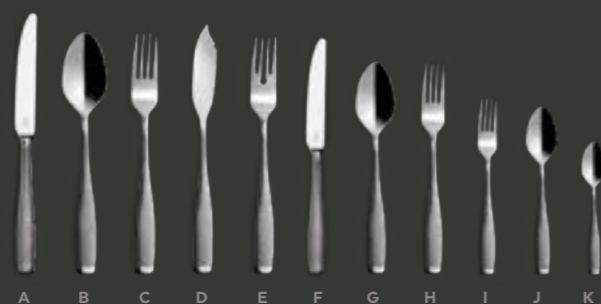

Fleur de Lys

INOX 18/10 / 4,5mm / Mirror



INOX
STAINLESS
STEEL
304

- A **7980** CUCHILLO MESA
table knife, couteau table, coltello tavola, tafelmesser
- B **7981** CUCHARA MESA
table spoon, cuillère table, cucchiaio tavola, tafellöffel
- C **7982** TENEDOR MESA
table fork, fourchette table, forchetta tavola, tafelgabel
- D **8007** PALA PESCADO
fish knife, couteau poisson, coltello pesce, fischmesser
- E **8008** TENEDOR PESCADO
fish fork, fourchette poisson, forchetta pesce, fischgabel
- F **7983** CUCHILLO POSTRE
dessert knife, couteau dessert, coltello frutta, dessertmesser
- G **7984** CUCHARA POSTRE
dessert spoon, cuillère dessert, cucchiaio frutta, dessertlöffel
- H **7985** TENEDOR POSTRE
dessert fork, fourchette dessert, forchetta frutta, dessertgabel
- I **7986** TENEDOR LUNCH
cake fork, fourchette gâteau, forchetta dolce, kuchengabel
- J **7987** CUCHARA CAFÉ
tea spoon, cuillère café, cucchiaio caffè, kaffeelöffel
- K **7988** CUCHARA MOKA
coffee/moka spoon, cuillère moka, cucchiaio moka, mokkalöffel

- 7989** 24 PIEZAS
24 pieces, écrin 24 pièces, bauletto 24 pz., 24 stück

UE	MOQ	✂ mm	✂ mm
0/12/120/1920/5760	60	235	
0/12/120/1440/7200	60	215	4,5
0/12/120/1440/7200	60	214	4,5
0/12/120/1440/7200	60	221	4,5
0/12/120/1440/7200	60	210	4,5
0/12/120/1920/5760	60	208	
0/12/120/1440/7200	60	189	4
0/12/120/1440/7200	60	186	4
0/12/120/2520/15120	60	156	3
0/12/120/2520/15120	60	150	3
0/12/120/2520/15120	60	118	2,5
1/0/4	4		4,5

Fleur de Lys Vintage Black



INOX 18/10 / 4,5mm / Vintage Black



A B C D E F G H I J K

Fleur de Lys Vintage Black

INOX 18/10 / 4,5mm / Vintage Black



INOX
STAINLESS
STEEL
304

A	6962	CUCHILLO MESA table knife, couteau table, coltello tavola, tafelmesser
B	6963	CUCHARA MESA table spoon, cuillère table, cucchiaio tavola, tafellöffel
C	6964	TENEDOR MESA table fork, fourchette table, forchetta tavola, tafelgabel
D	6965	PALA PESCADO fish knife, couteau poisson, coltello pesce, fischmesser
E	6966	TENEDOR PESCADO fish fork, fourchette poisson, forchetta pesce, fischgabel
F	6967	CUCHILLO POSTRE dessert knife, couteau dessert, coltello frutta, dessertmesser
G	6968	CUCHARA POSTRE dessert spoon, cuillère dessert, cucchiaio frutta, dessertlöffel
H	6969	TENEDOR POSTRE dessert fork, fourchette dessert, forchetta frutta, dessertgabel
I	6970	TENEDOR LUNCH cake fork, fourchette gâteau, forchetta dolce, kuchengabel
J	6971	CUCHARA CAFÉ tea spoon, cuillère café, cucchiaio caffè, kaffeelöffel
K	6972	CUCHARA MOKA coffee/moka spoon, cuillère moka, cucchiaio moka, mokkalöffel

6973 24 PIEZAS
24 pieces, écrin 24 pièces, bauletto 24 pz., 24 stück

UE	MOQ	✂ mm	✂ mm
0/12/120/1920/5760	60	235	
0/12/120/1440/7200	60	215	4,5
0/12/120/1440/7200	60	214	4,5
0/12/120/1440/7200	60	221	4,5
0/12/120/1440/7200	60	210	4,5
0/12/120/1920/5760	60	208	
0/12/120/1440/7200	60	189	4
0/12/120/1440/7200	60	186	4
0/12/120/2520/15120	60	156	3
0/12/120/2520/15120	60	150	3
0/12/120/2520/15120	60	118	2,5
1/0/4	4		4,5

Oslo

INOX 18/10 / 7mm / Mirror / FORGED



INOX STAINLESS STEEL 304

A	3619	CUCHILLO CHULETERO steak knife, couteau steak, coltello bistecca, steakmesser
B	5474	CUCHILLO MESA table knife, couteau table, coltello tavola, tafelmesser
C	5475	CUCHARA MESA table spoon, cuillère table, cucchiaio tavola, tafellöffel
D	5476	TENEDOR MESA table fork, fourchette table, forchetta tavola, tafelgabel
E	5483	PALA PESCADO fish knife, couteau poisson, coltello pesce, fischmesser
F	5484	TENEDOR PESCADO fish fork, fourchette poisson, forchetta pesce, fischgabel
G	2171	CUCHILLO POSTRE dessert knife, couteau dessert, coltello frutta, dessertmesser
H	5485	CUCHARA POSTRE dessert spoon, cuillère dessert, cucchiaio frutta, dessertlöffel
I	5486	TENEDOR POSTRE dessert fork, fourchette dessert, forchetta frutta, dessertgabel
J	5478	TENEDOR LUNCH cake fork, fourchette gâteau, forchetta dolce, kuchengabel
K	5477	CUCHARA CAFÉ tea spoon, cuillère café, cucchiaio caffè, kaffeelöffel
L	5479	CUCHARA MOKA coffee/moka spoon, cuillère moka, cucchiaio moka, mokkalöffel

1600 24 PIEZAS
24 pieces, écriin 24 pièces, bauletto 24 pz., 24 stück

NEW



Oslo Ocean Free

INOX 18/10 / 4mm / Satin / Nylon



La colección OSLO OCEAN FREE ha sido producida con NYLON que provienen del plástico recuperado y reciclado. Este material, que constituye una parte significativa de los desechos plásticos en el océano, se recolecta, limpia y recicla mediante procesos avanzados para transformarlo en materias primas reutilizables.

Su fabricación supone una reducción de la huella de carbono y reduce el impacto sobre el medio ambiente frente a otros materiales.

The OSLO OCEAN FREE collection has been produced with NYLON from recovered and recycled plastic. This material, which constitutes a significant portion of the plastic waste in the ocean, is collected, cleaned, and recycled through advanced processes to transform it into reusable raw materials.

In addition, its manufacture reduces the carbon footprint and reduces the impact on the environment compared to other materials.

INOX STAINLESS STEEL 430

A	12024	CUCHILLO MESA table knife, couteau table, coltello tavola, tafelmesser
B	12025	CUCHARA MESA table spoon, cuillère table, cucchiaio tavola, tafellöffel
C	12026	TENEDOR MESA table fork, fourchette table, forchetta tavola, tafelgabel
D	12027	CUCHARA CAFÉ tea spoon, cuillère café, cucchiaio caffè, kaffeelöffel

12028 24 PIEZAS
24 pieces, écriin 24 pièces, bauletto 24 pz., 24 stück

UE	MOQ	▶ mm	✂ mm
0/12/120/1920/5760	60	226	0
0/12/120/1440/7200	60	210	4
0/12/120/1440/7200	60	210	4
0/12/120/2520/15120	60	150	3,5
1/0/4/56/112	4		4

Dalia

INOX 18/10 / 8,5mm / Mirror / Forged



INOX STAINLESS STEEL 304

A	7057	CUCHILLO MESA table knife, couteau table, coltello tavola, tafelmesser
B	7058	CUCHARA MESA table spoon, cuillère table, cucchiaio tavola, tafellöffel
C	7059	TENEDOR MESA table fork, fourchette table, forchetta tavola, tafelgabel
D	7060	CUCHILLO POSTRE dessert knife, couteau dessert, coltello frutta, dessertmesser
E	7061	CUCHARA POSTRE dessert spoon, cuillère dessert, cucchiaio frutta, dessertlöffel
F	7062	TENEDOR POSTRE dessert fork, fourchette dessert, forchetta frutta, dessertgabel
G	7063	TENEDOR LUNCH cake fork, fourchette gâteau, forchetta dolce, kuchengabel
H	7064	CUCHARA CAFÉ/TE coffee/iced tea spoon, cuillère café/té, cucchiaio caffè/the, cocktaillöffel
I	7065	CUCHARA MOKA coffee/moka spoon, cuillère moka, cucchiaio moka, mokkalöffel

UE	MOQ	✂ mm	✂ mm
0/12/120/1920/5760	60	234	
0/12/120/1440/7200	60	205	8,5
0/12/120/1440/7200	60	204	8,5
0/12/120/1920/5760	60	210	
0/12/120/1440/7200	60	182	7,5
0/12/120/1440/7200	60	181	7,5
0/12/120/2520/15120	60	156	6,4
0/12/120/2520/15120	60	154	6,4
0/12/120/2520/15120	60	108	4,5
1/0/4	4		8,5



Iris

INOX 18/10 / 6mm / Mirror

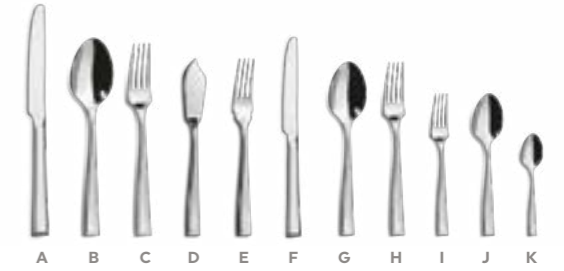

INOX STAINLESS STEEL 304

A	7022	CUCHILLO MESA table knife, couteau table, coltello tavola, tafelmesser
B	7023	CUCHARA MESA table spoon, cuillère table, cucchiaio tavola, tafellöffel
C	7024	TENEDOR MESA table fork, fourchette table, forchetta tavola, tafelgabel
D	7025	PALA PESCADO fish knife, couteau poisson, coltello pesce, fischmesser
E	7026	TENEDOR PESCADO fish fork, fourchette poisson, forchetta pesce, fischgabel
F	7027	CUCHILLO POSTRE dessert knife, couteau dessert, coltello frutta, dessertmesser
G	7028	CUCHARA POSTRE dessert spoon, cuillère dessert, cucchiaio frutta, dessertlöffel
H	7029	TENEDOR POSTRE dessert fork, fourchette dessert, forchetta frutta, dessertgabel
I	7030	TENEDOR LUNCH cake fork, fourchette gâteau, forchetta dolce, kuchengabel
J	7031	CUCHARA CAFÉ tea spoon, cuillère café, cucchiaio caffè, kaffeelöffel
K	7032	CUCHARA MOKA coffee/moka spoon, cuillère moka, cucchiaio moka, mokkalöffel

UE	MOQ	✂ mm	✂ mm
0/12/120/1920/5760	60	243	8
0/12/120/1440/7200	60	209	6
0/12/120/1440/7200	60	209	6
0/12/120/1440/7200	60	188	5
0/12/120/1440/7200	60	188	5
0/12/120/1920/5760	60	210	7
0/12/120/1440/7200	60	184	5
0/12/120/1440/7200	60	184	5
0/12/120/2520/15120	60	151	4,5
0/12/120/2520/15120	60	151	4,5
0/12/120/2520/15120	60	108	4
1/0/4	4		6



Callas

INOX 18/10 / 3,5mm / Mirror

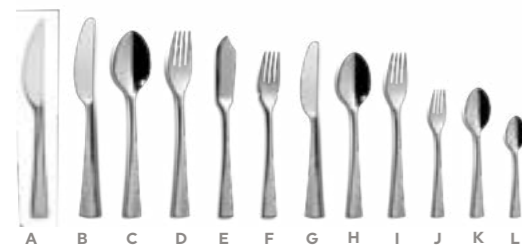

Sangiovese

INOX 18/10 / 3,5mm / Mirror

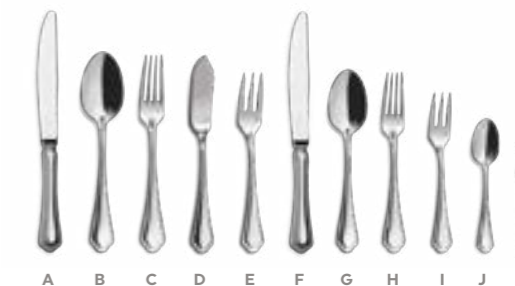

INOX
STAINLESS
STEEL
304

	UE	MOQ	▶ mm	✕ mm
A 7010 CUCHILLO CHULETERO steak knife, couteau steak, coltello bistecca, steakmesser	0/12/120/1920/5760	60	225	7
B 7011 CUCHILLO MESA table knife, couteau table, coltello tavola, tafelmesser	0/12/120/1920/5760	60	225	7
C 7012 CUCHARA MESA table spoon, cuillère table, cucchiaio tavola, tafellöffel	0/12/120/1440/7200	60	215	3,5
D 7013 TENEDOR MESA table fork, fourchette table, forchetta tavola, tafelgabel	0/12/120/1440/7200	60	212	3,5
E 7014 PALA PESCADO fish knife, couteau poisson, coltello pesce, fischmesser	0/12/120/1440/7200	60	205	3
F 7015 TENEDOR PESCADO fish fork, fourchette poisson, forchetta pesce, fischgabel	0/12/120/1440/7200	60	188	3
G 7016 CUCHILLO POSTRE dessert knife, couteau dessert, coltello frutta, dessertmesser	0/12/120/1920/5760	60	203	6
H 7017 CUCHARA POSTRE dessert spoon, cuillère dessert, cucchiaio frutta, dessertlöffel	0/12/120/1440/7200	60	185	3
I 7018 TENEDOR POSTRE dessert fork, fourchette dessert, forchetta frutta, dessertgabel	0/12/120/1440/7200	60	185	3
J 7019 TENEDOR LUNCH cake fork, fourchette gâteau, forchetta dolce, kuchengabel	0/12/120/2520/15120	60	145	2,5
K 7020 CUCHARA CAFÉ tea spoon, cuillère café, cucchiaio caffè, kaffeelöffel	0/12/120/2520/15120	60	147	2,5
L 7021 CUCHARA MOKA coffee/moka spoon, cuillère moka, cucchiaio moka, mokkalöffel	0/12/120/2520/15120	60	115	2

5964 24 PIEZAS
24 pieces, écrin 24 pièces, bauletto 24 pz., 24 stück

INOX
STAINLESS
STEEL
304

	UE	MOQ	▶ mm	✕ mm
A 6895 CUCHILLO MESA table knife, couteau table, coltello tavola, tafelmesser	0/12/120/1920/5760	60	255	
B 6896 CUCHARA MESA table spoon, cuillère table, cucchiaio tavola, tafellöffel	0/12/120/1440/7200	60	209	3,5
C 6897 TENEDOR MESA table fork, fourchette table, forchetta tavola, tafelgabel	0/12/120/1440/7200	60	209	3,5
D 6898 PALA PESCADO fish knife, couteau poisson, coltello pesce, fischmesser	0/12/120/1440/7200	60	208	3
E 6899 TENEDOR PESCADO fish fork, fourchette poisson, forchetta pesce, fischgabel	0/12/120/1440/7200	60	190	3
F 6900 CUCHILLO POSTRE dessert knife, couteau dessert, coltello frutta, dessertmesser	0/12/120/1920/5760	60	232	
G 6901 CUCHARA POSTRE dessert spoon, cuillère dessert, cucchiaio frutta, dessertlöffel	0/12/120/1440/7200	60	190	3
H 6902 TENEDOR POSTRE dessert fork, fourchette dessert, forchetta frutta, dessertgabel	0/12/120/1440/7200	60	190	3
I 6903 TENEDOR LUNCH cake fork, fourchette gâteau, forchetta dolce, kuchengabel	0/12/120/2520/15120	60	170	3
J 6904 CUCHARA CAFÉ tea spoon, cuillère café, cucchiaio caffè, kaffeelöffel	0/12/120/2520/15120	60	142	3
K 6905 CUCHARA MOKA coffee/moka spoon, cuillère moka, cucchiaio moka, mokkalöffel	0/12/120/2520/15120	60	111	2

6906 24 PIEZAS
24 pieces, écrin 24 pièces, bauletto 24 pz., 24 stück

	UE	MOQ	▶ mm	✕ mm
A 6895 CUCHILLO MESA table knife, couteau table, coltello tavola, tafelmesser	0/12/120/1920/5760	60	255	
B 6896 CUCHARA MESA table spoon, cuillère table, cucchiaio tavola, tafellöffel	0/12/120/1440/7200	60	209	3,5
C 6897 TENEDOR MESA table fork, fourchette table, forchetta tavola, tafelgabel	0/12/120/1440/7200	60	209	3,5
D 6898 PALA PESCADO fish knife, couteau poisson, coltello pesce, fischmesser	0/12/120/1440/7200	60	208	3
E 6899 TENEDOR PESCADO fish fork, fourchette poisson, forchetta pesce, fischgabel	0/12/120/1440/7200	60	190	3
F 6900 CUCHILLO POSTRE dessert knife, couteau dessert, coltello frutta, dessertmesser	0/12/120/1920/5760	60	232	
G 6901 CUCHARA POSTRE dessert spoon, cuillère dessert, cucchiaio frutta, dessertlöffel	0/12/120/1440/7200	60	190	3
H 6902 TENEDOR POSTRE dessert fork, fourchette dessert, forchetta frutta, dessertgabel	0/12/120/1440/7200	60	190	3
I 6903 TENEDOR LUNCH cake fork, fourchette gâteau, forchetta dolce, kuchengabel	0/12/120/2520/15120	60	170	3
J 6904 CUCHARA CAFÉ tea spoon, cuillère café, cucchiaio caffè, kaffeelöffel	0/12/120/2520/15120	60	142	3
K 6905 CUCHARA MOKA coffee/moka spoon, cuillère moka, cucchiaio moka, mokkalöffel	0/12/120/2520/15120	60	111	2

6906 24 PIEZAS
24 pieces, écrin 24 pièces, bauletto 24 pz., 24 stück

Sangiovese Gold

INOX 18/10 / 3,5mm / Mirror



Sangiovese Vintage Copper

INOX 18/10 / 3,5mm / Vintage



INOX
STAINLESS
STEEL
304

- A **7271** CUCHILLO MESA
table knife, couteau table, coltello tavola, tafelmesser
- B **7418** CUCHARA MESA
table spoon, cuillère table, cucchiaio tavola, tafellöffel
- C **7272** TENEDOR MESA
table fork, fourchette table, forchetta tavola, tafelgabel
- D **7420** CUCHILLO POSTRE
dessert knife, couteau dessert, coltello frutta, dessertmesser
- E **7419** CUCHARA POSTRE
dessert spoon, cuillère dessert, cucchiaio frutta, dessertlöffel
- F **7273** TENEDOR POSTRE
dessert fork, fourchette dessert, forchetta frutta, dessertgabel
- G **7957** TENEDOR LUNCH
cake fork, fourchette gâteau, forchetta dolce, kuchengabel
- H **7274** CUCHARA CAFÉ
tea spoon, cuillère café, cucchiaio caffè, kaffeelöffel
- I **7275** CUCHARA MOKA
coffee/moka spoon, cuillère moka, cucchiaio moka, mokkalöffel

5554 24 PIEZAS
24 pieces, écriin 24 pièces, bauletto 24 pz., 24 stück

UE	MOQ	✂ mm	✂ mm
0/12/120/1920/5760	60	255	
0/12/120/1440/7200	60	209	3,5
0/12/120/1440/7200	60	209	3,5
0/12/120/1920/5760	60	232	
0/12/120/1440/7200	60	190	3
0/12/120/1440/7200	60	190	3
0/12/120/2520/15120	60	170	3
0/12/120/2520/15120	60	142	3
0/12/120/2520/15120	60	111	2



INOX
STAINLESS
STEEL
304

- A **5763** CUCHILLO MESA
table knife, couteau table, coltello tavola, tafelmesser
- B **5764** CUCHARA MESA
table spoon, cuillère table, cucchiaio tavola, tafellöffel
- C **7737** TENEDOR MESA
table fork, fourchette table, forchetta tavola, tafelgabel
- D **5765** CUCHILLO POSTRE
dessert knife, couteau dessert, coltello frutta, dessertmesser
- E **5766** CUCHARA POSTRE
dessert spoon, cuillère dessert, cucchiaio frutta, dessertlöffel
- F **5767** TENEDOR POSTRE
dessert fork, fourchette dessert, forchetta frutta, dessertgabel
- G **5768** TENEDOR LUNCH
cake fork, fourchette gâteau, forchetta dolce, kuchengabel
- H **5769** CUCHARA CAFÉ
tea spoon, cuillère café, cucchiaio caffè, kaffeelöffel
- I **5770** CUCHARA MOKA
coffee/moka spoon, cuillère moka, cucchiaio moka, mokkalöffel

5557 24 PIEZAS
24 pieces, écriin 24 pièces, bauletto 24 pz., 24 stück

UE	MOQ	✂ mm	✂ mm
0/12/120/1920/5760	60	255	
0/12/120/1440/7200	60	209	3,5
0/12/120/1440/7200	60	209	3,5
0/12/120/1920/5760	60	232	
0/12/120/1440/7200	60	190	3
0/12/120/1440/7200	60	190	3
0/12/120/2520/15120	60	170	3
0/12/120/2520/15120	60	142	3
0/12/120/2520/15120	60	111	2





BAJO PEDIDO
ON DEMAND

INOX 18/10 / 4mm / Mirror



- A **6525** CUCHILLO MESA
table knife, couteau table, coltello tavola, tafelmesser
- B **6526** CUCHARA MESA
table spoon, cuillère table, cucchiaio tavola, tafellöffel
- C **6527** TENEDOR MESA
table fork, fourchette table, forchetta tavola, tafelgabel
- D **6528** PALA PESCADO
fish knife, couteau poisson, coltello pesce, fischmesser
- E **6529** TENEDOR PESCADO
fish fork, fourchette poisson, forchetta pesce, fischgabel
- F **6530** CUCHILLO POSTRE
dessert knife, couteau dessert, coltello frutta, dessertmesser
- G **6531** CUCHARA POSTRE
dessert spoon, cuillère dessert, cucchiaio frutta, dessertlöffel
- H **6532** TENEDOR POSTRE
dessert fork, fourchette dessert, forchetta frutta, dessertgabel
- I **6533** TENEDOR LUNCH
cake fork, fourchette gâteau, forchetta dolce, kuchengabel
- J **6534** CUCHARA CAFÉ
tea spoon, cuillère café, cucchiaio caffè, kaffeelöffel
- K **6535** CUCHARA MOKA
coffee/moka spoon, cuillère moka, cucchiaio moka, mokkalöffel

6536 24 PIEZAS
24 pieces, écrin 24 pièces, bauletto 24 pz., 24 stück

UE	MOQ	▶ mm	✕ mm
0/12/120/1920/5760	60	238	
0/12/120/1440/7200	60	213	4
0/12/120/1440/7200	60	213	4
0/12/120/1440/7200	60	224	4
0/12/120/1440/7200	60	200	4
0/12/120/1920/5760	60	216	
0/12/120/1440/7200	60	192	3,5
0/12/120/1440/7200	60	192	3,5
0/12/120/2520/15120	60	140	3
0/12/120/2520/15120	60	140	3
0/12/120/2520/15120	60	115	2,5
1/0/4	4		4





INOX 18/10 / 4mm / Mirror



INOX
STAINLESS
STEEL
304

- A **7968** CUCHILLO MESA
table knife, couteau table, coltello tavola, tafelmesser
- B **7969** CUCHARA MESA
table spoon, cuillère table, cucchiaio tavola, tafellöffel
- C **7970** TENEDOR MESA
table fork, fourchette table, forchetta tavola, tafelgabel
- D **7971** PALA PESCADO
fish knife, couteau poisson, coltello pesce, fischmesser
- E **7972** TENEDOR PESCADO
fish fork, fourchette poisson, forchetta pesce, fischgabel
- F **7973** CUCHILLO POSTRE
dessert knife, couteau dessert, coltello frutta, dessertmesser
- G **7974** CUCHARA POSTRE
dessert spoon, cuillère dessert, cucchiaio frutta, dessertlöffel
- H **7975** TENEDOR POSTRE
dessert fork, fourchette dessert, forchetta frutta, dessertgabel
- I **7976** TENEDOR LUNCH
cake fork, fourchette gâteau, forchetta dolce, kuchengabel
- J **7977** CUCHARA CAFÉ
tea spoon, cuillère café, cucchiaio caffè, kaffeelöffel
- K **7978** CUCHARA MOKA
coffee/moka spoon, cuillère moka, cucchiaio moka, mokkalöffel

- 7979** 24 PIEZAS
24 pieces, écriin 24 pièces, bauletto 24 pz., 24 stück

UE	MOQ	◀ mm	✂ mm
0/12/60/1920/5760	60	238	
0/12/60/1440/7200	60	213	4
0/12/60/1440/7200	60	213	4
0/12/60/1440/7200	60	224	4
0/12/60/1440/7200	60	200	4
0/12/60/1920/5760	60	216	
0/12/60/1440/7200	60	192	3,5
0/12/60/1440/7200	60	192	3,5
0/12/60/2520/15120	60	140	3
0/12/60/2520/15120	60	140	3
0/12/60/2520/15120	60	115	2,5
1/0/4	4		4



Contour Vintage Gold

INOX 18/10 / 4mm / Vintage

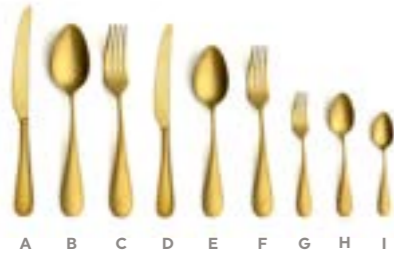

Contour Vintage Copper

INOX 18/10 / 4mm / Vintage



INOX
STAINLESS
STEEL
304

- A **5783** CUCHILLO MESA
table knife, couteau table, coltello tavola, tafelmesser
- B **5784** CUCHARA MESA
table spoon, cuillère table, cucchiaio tavola, tafellöffel
- C **5785** TENEDOR MESA
table fork, fourchette table, forchetta tavola, tafelgabel
- D **5786** CUCHILLO POSTRE
dessert knife, couteau dessert, coltello frutta, dessertmesser
- E **5787** CUCHARA POSTRE
dessert spoon, cuillère dessert, cucchiaio frutta, dessertlöffel
- F **5788** TENEDOR POSTRE
dessert fork, fourchette dessert, forchetta frutta, dessertgabel
- G **5789** TENEDOR LUNCH
cake fork, fourchette gâteau, forchetta dolce, kuchengabel
- H **5790** CUCHARA CAFÉ
tea spoon, cuillère café, cucchiaio caffè, kaffeelöffel
- I **5791** CUCHARA MOKA
coffee/moka spoon, cuillère moka, cucchiaio moka, mokkalöffel

5792 24 PIEZAS
24 pieces, écriin 24 pièces, bauletto 24 pz., 24 stück

UE	MOQ	▶ mm	✕ mm
0/12/60/1920/5760	60	238	
0/12/60/1440/7200	60	213	4
0/12/60/1440/7200	60	213	4
0/12/60/1920/5760	60	216	
0/12/60/1440/7200	60	192	3,5
0/12/60/1440/7200	60	192	3,5
0/12/60/2520/15120	60	140	3
0/12/60/2520/15120	60	140	3
0/12/60/2520/15120	60	115	2,5
1/0/4	4		4

INOX
STAINLESS
STEEL
304

**BAJO PEDIDO
ON DEMAND**

- A **5771** CUCHILLO MESA
table knife, couteau table, coltello tavola, tafelmesser
- B **5772** CUCHARA MESA
table spoon, cuillère table, cucchiaio tavola, tafellöffel
- C **5773** TENEDOR MESA
table fork, fourchette table, forchetta tavola, tafelgabel
- D **5774** CUCHILLO POSTRE
dessert knife, couteau dessert, coltello frutta, dessertmesser
- E **5775** CUCHARA POSTRE
dessert spoon, cuillère dessert, cucchiaio frutta, dessertlöffel
- F **5776** TENEDOR POSTRE
dessert fork, fourchette dessert, forchetta frutta, dessertgabel
- G **5777** TENEDOR LUNCH
cake fork, fourchette gâteau, forchetta dolce, kuchengabel
- H **5778** CUCHARA CAFÉ
tea spoon, cuillère café, cucchiaio caffè, kaffeelöffel
- I **5779** CUCHARA MOKA
coffee/moka spoon, cuillère moka, cucchiaio moka, mokkalöffel

5780 24 PIEZAS
24 pieces, écriin 24 pièces, bauletto 24 pz., 24 stück

UE	MOQ	▶ mm	✕ mm
0/12/60/1920/5760	60	238	
0/12/60/1440/7200	60	213	4
0/12/60/1440/7200	60	213	4
0/12/60/1920/5760	60	216	
0/12/60/1440/7200	60	192	3,5
0/12/60/1440/7200	60	192	3,5
0/12/60/2520/15120	60	140	3
0/12/60/2520/15120	60	140	3
0/12/60/2520/15120	60	115	2,5
1/0/4	4		4

Versailles Satin

INOX 18/10 / 3,5mm / Satin



INOX
STAINLESS
STEEL
304

- A **7765** CUCHILLO MESA
table knife, couteau table, coltello tavola, tafelmesser
- B **7766** CUCHARA MESA
table spoon, cuillère table, cucchiaio tavola, tafellöffel
- C **7767** TENEDOR MESA
table fork, fourchette table, forchetta tavola, tafelgabel
- D **7770** CUCHILLO POSTRE
dessert knife, couteau dessert, coltello frutta, dessertmesser
- E **7771** CUCHARA POSTRE
dessert spoon, cuillère dessert, cucchiaio frutta, dessertlöffel
- F **7772** TENEDOR POSTRE
dessert fork, fourchette dessert, forchetta frutta, dessertgabel
- G **7773** TENEDOR LUNCH
cake fork, fourchette gâteau, forchetta dolce, kuchengabel
- H **7774** CUCHARA CAFÉ
tea spoon, cuillère café, cucchiaio caffè, kaffeelöffel
- I **7775** CUCHARA MOKA
coffee/moka spoon, cuillère moka, cucchiaio moka, mokkalöffel

7776 24 PIEZAS
24 pieces, écriin 24 pièces, bauletto 24 pz., 24 stück

UE	MOQ	▶ mm	✂ mm
0/12/60/1920/5760	60	245	
0/12/60/1440/7200	60	210	3,5
0/12/60/1440/7200	60	210	3,5
0/12/60/1920/5760	60	220	
0/12/60/1440/7200	60	190	3
0/12/60/1440/7200	60	190	3
0/12/60/2520/15120	60	140	2,5
0/12/60/2520/15120	60	140	2,5
0/12/60/2520/15120	60	115	1,8
1/0/4	4		3,5



Versailles Satin Copper

INOX 18/10 / 3,5mm / Satin



INOX
STAINLESS
STEEL
304

**BAJO PEDIDO
ON DEMAND**

- A **5754** CUCHILLO MESA
table knife, couteau table, coltello tavola, tafelmesser
- B **5755** CUCHARA MESA
table spoon, cuillère table, cucchiaio tavola, tafellöffel
- C **5756** TENEDOR MESA
table fork, fourchette table, forchetta tavola, tafelgabel
- D **5757** CUCHILLO POSTRE
dessert knife, couteau dessert, coltello frutta, dessertmesser
- E **5758** CUCHARA POSTRE
dessert spoon, cuillère dessert, cucchiaio frutta, dessertlöffel
- F **5759** TENEDOR POSTRE
dessert fork, fourchette dessert, forchetta frutta, dessertgabel
- G **5760** TENEDOR LUNCH
cake fork, fourchette gâteau, forchetta dolce, kuchengabel
- H **5761** CUCHARA CAFÉ
tea spoon, cuillère café, cucchiaio caffè, kaffeelöffel
- I **5762** CUCHARA MOKA
coffee/moka spoon, cuillère moka, cucchiaio moka, mokkalöffel

8806 24 PIEZAS
24 pieces, écriin 24 pièces, bauletto 24 pz., 24 stück

UE	MOQ	▶ mm	✂ mm
0/12/60/1920/5760	60	245	
0/12/60/1440/7200	60	210	3,5
0/12/60/1440/7200	60	210	3,5
0/12/60/1920/5760	60	220	
0/12/60/1440/7200	60	190	3
0/12/60/1440/7200	60	190	3
0/12/60/2520/15120	60	140	2,5
0/12/60/2520/15120	60	140	2,5
0/12/60/2520/15120	60	115	1,8
1/0/4	4		3,5



Versailles Satin Gold

INOX 18/10 / 3,5mm / Satin



Versailles Satin Black

INOX 18/10 / 3,5mm / Satin



INOX STAINLESS STEEL 304



BAJO PEDIDO ON DEMAND

- A **5736** CUCHILLO MESA
table knife, couteau table, coltello tavola, tafelmesser
- B **5737** CUCHARA MESA
table spoon, cuillère table, cucchiaio tavola, tafellöffel
- C **5738** Tenedor MESA
table fork, fourchette table, forchetta tavola, tafelgabel
- D **5739** CUCHILLO POSTRE
dessert knife, couteau dessert, coltello frutta, dessertmesser
- E **5740** CUCHARA POSTRE
dessert spoon, cuillère dessert, cucchiaio frutta, dessertlöffel
- F **5741** Tenedor POSTRE
dessert fork, fourchette dessert, forchetta frutta, dessertgabel
- G **5742** Tenedor LUNCH
cake fork, fourchette gâteau, forchetta dolce, kuchengabel
- H **5743** CUCHARA CAFÉ
tea spoon, cuillère café, cucchiaio caffè, kaffeelöffel
- I **5744** CUCHARA MOKA
coffee/moka spoon, cuillère moka, cucchiaio moka, mokkalöffel

8800 24 PIEZAS
24 pieces, écriin 24 pièces, bauletto 24 pz., 24 stück

UE **MOQ** **▶ mm** **✂ mm**

A	0/12/60/1920/5760	60	245	
B	0/12/60/1440/7200	60	210	3,5
C	0/12/60/1440/7200	60	210	3,5
D	0/12/60/1920/5760	60	220	
E	0/12/60/1440/7200	60	190	3
F	0/12/60/1440/7200	60	190	3
G	0/12/60/2520/15120	60	140	2,5
H	0/12/60/2520/15120	60	140	2,5
I	0/12/60/2520/15120	60	115	1,8



INOX STAINLESS STEEL 304



BAJO PEDIDO ON DEMAND

- A **5745** CUCHILLO MESA
table knife, couteau table, coltello tavola, tafelmesser
- B **5746** CUCHARA MESA
table spoon, cuillère table, cucchiaio tavola, tafellöffel
- C **5747** Tenedor MESA
table fork, fourchette table, forchetta tavola, tafelgabel
- D **5748** CUCHILLO POSTRE
dessert knife, couteau dessert, coltello frutta, dessertmesser
- E **5749** CUCHARA POSTRE
dessert spoon, cuillère dessert, cucchiaio frutta, dessertlöffel
- F **5750** Tenedor POSTRE
dessert fork, fourchette dessert, forchetta frutta, dessertgabel
- G **5751** Tenedor LUNCH
cake fork, fourchette gâteau, forchetta dolce, kuchengabel
- H **5752** CUCHARA CAFÉ
tea spoon, cuillère café, cucchiaio caffè, kaffeelöffel
- I **5753** CUCHARA MOKA
coffee/moka spoon, cuillère moka, cucchiaio moka, mokkalöffel

8803 24 PIEZAS
24 pieces, écriin 24 pièces, bauletto 24 pz., 24 stück

UE **MOQ** **▶ mm** **✂ mm**

A	0/12/60/1920/5760	60	245	
B	0/12/60/1440/7200	60	210	3,5
C	0/12/60/1440/7200	60	210	3,5
D	0/12/60/1920/5760	60	220	
E	0/12/60/1440/7200	60	190	3
F	0/12/60/1440/7200	60	190	3
G	0/12/60/2520/15120	60	140	2,5
H	0/12/60/2520/15120	60	140	2,5
I	0/12/60/2520/15120	60	115	1,8





INOX 18/10 / 4mm / Mirror



	UE	MOQ	▶ mm	✕ mm
A 7288 CUCHILLO MESA CLASICO classic table knife, couteau table classic, coltello tavola classic, tafelmesser classic	0/12/120/1920/5760	60	238	
B 6485 CUCHILLO MESA table knife, couteau table, coltello tavola, tafelmesser	0/12/120/1920/5760	60	238	
C 6486 CUCHARA MESA table spoon, cuillère table, cucchiaino tavola, tafellöffel	0/12/120/1440/7200	60	212	4
D 6487 TENEDOR MESA table fork, fourchette table, forchetta tavola, tafelgabel	0/12/120/1440/7200	60	212	4
E 6488 PALA PESCADO fish knife, couteau poisson, coltello pesce, fischmesser	0/12/120/1440/7200	60	215	4
F 6489 TENEDOR PESCADO fish fork, fourchette poisson, forchetta pesce, fischgabel	0/12/120/1440/7200	60	200	4
G 6691 CUCHILLO POSTRE CLASICO classic dessert knife, couteau dessert classic, coltello frutta classic, dessertmesser classic	0/12/120/1920/5760	60	214	
H 6490 CUCHILLO POSTRE dessert knife, couteau dessert, coltello frutta, dessertmesser	0/12/120/1920/5760	60	214	
I 6491 CUCHARA POSTRE dessert spoon, cuillère dessert, cucchiaino frutta, dessertlöffel	0/12/120/1440/7200	60	191	3,5
J 6492 TENEDOR POSTRE dessert fork, fourchette dessert, forchetta frutta, dessertgabel	0/12/120/1440/7200	60	191	3,5
K 6493 TENEDOR LUNCH cake fork, fourchette gâteau, forchetta dolce, kuchengabel	0/12/120/2520/15120	60	140	3,5
L 6494 CUCHARA CAFÉ tea spoon, cuillère café, cucchiaino caffè, kaffeelöffel	0/12/120/2520/15120	60	140	3,5
M 6495 CUCHARA MOKA coffee/moka spoon, cuillère moka, cucchiaino moka, mokkalöffel	0/12/120/2520/15120	60	114	3,5

6496 24 PIEZAS
24 pieces, écriin 24 pièces, bauletto 24 pz., 24 stück

UE	MOQ	▶ mm	✕ mm
1/0/4	4		3,5



Maranta Vintage



INOX 18/10 / 4mm / Vintage



A B C D E F G H I J K L M

Maranta Vintage

INOX 18/10 / 4mm / Vintage



INOX
STAINLESS
STEEL
304

- A **7784** CUCHILLO MESA CLASICO
classic table knife, couteau table classic, coltello tavola classic, tafelmesser classic
- B **6793** CUCHILLO MESA
table knife, couteau table, coltello tavola, tafelmesser
- C **6794** CUCHARA MESA
table spoon, cuillère table, cucchiaio tavola, tafellöffel
- D **6795** TENEDOR MESA
table fork, fourchette table, forchetta tavola, tafelgabel
- E **6796** PALA PESCADO
fish knife, couteau poisson, coltello pesce, fischmesser
- F **6797** TENEDOR PESCADO
fish fork, fourchette poisson, forchetta pesce, fischgabel
- G **6692** CUCHILLO POSTRE CLASICO
classic dessert knife, couteau dessert classic, coltello frutta classic, dessertmesser classic
- H **6798** CUCHILLO POSTRE
dessert knife, couteau dessert, coltello frutta, dessertmesser
- I **6799** CUCHARA POSTRE
dessert spoon, cuillère dessert, cucchiaio frutta, dessertlöffel
- J **6800** TENEDOR POSTRE
dessert fork, fourchette dessert, forchetta frutta, dessertgabel
- K **6801** TENEDOR LUNCH
cake fork, fourchette gâteau, forchetta dolce, kuchengabel
- L **6802** CUCHARA CAFÉ
tea spoon, cuillère café, cucchiaio caffè, kaffeelöffel
- M **6803** CUCHARA MOKA
coffee/moka spoon, cuillère moka, cucchiaio moka, mokkalöffel

6804 24 PIEZAS
24 pieces, écriin 24 pièces, bauletto 24 pz., 24 stück

UE	MOQ	▶▶ mm	✂ mm
0/12/120/1920/5760	60	238	
0/12/120/1920/5760	60	238	
0/12/120/1440/7200	60	212	4
0/12/120/1440/7200	60	212	4
0/12/120/1440/7200	60	215	4
0/12/120/1440/7200	60	200	4
0/12/120/1920/5760	60	214	
0/12/120/1920/5760	60	214	
0/12/120/1440/7200	60	191	3,5
0/12/120/1440/7200	60	191	3,5
0/12/120/2520/15120	60	140	3,5
0/12/120/2520/15120	60	140	3,5
0/12/120/2520/15120	60	114	3,5
1/0/4	4		4





INOX 18/10 / 4mm / Mirror



INOX
STAINLESS
STEEL
304

- A **6700** CUCHILLO CHULETERO
steak knife, couteau steak, coltello bistecca, steakmesser
- B **6701** CUCHILLO MESA
table knife, couteau table, coltello tavola, tafelmesser
- C **6702** CUCHARA MESA
table spoon, cuillère table, cucchiaio tavola, tafellöffel
- D **6703** TENEDOR MESA
table fork, fourchette table, forchetta tavola, tafelgabel
- E **6497** PALA PESCADO
fish knife, couteau poisson, coltello pesce, fischmesser
- F **6498** TENEDOR PESCADO
fish fork, fourchette poisson, forchetta pesce, fischgabel
- G **6704** CUCHILLO POSTRE
dessert knife, couteau dessert, coltello frutta, dessertmesser
- H **6705** CUCHARA POSTRE
dessert spoon, cuillère dessert, cucchiaio frutta, dessertlöffel
- I **6706** TENEDOR POSTRE
dessert fork, fourchette dessert, forchetta frutta, dessertgabel
- J **6707** TENEDOR LUNCH
cake fork, fourchette gâteau, forchetta dolce, kuchengabel
- K **6708** CUCHARA CAFÉ
tea spoon, cuillère café, cucchiaio caffè, kaffeelöffel
- L **6709** CUCHARA MOKA
coffee/moka spoon, cuillère moka, cucchiaio moka, mokkalöffel

6710 24 PIEZAS
24 pieces, écriin 24 pièces, bauletto 24 pz, 24 stück

UE	MOQ	▶ mm	✕ mm
0/12/120/1920/5760	60	233	
0/12/120/1920/5760	60	228	
0/12/120/1440/7200	60	208	4
0/12/120/1440/7200	60	208	4
0/12/120/1440/7200	60	212	4
0/12/120/1440/7200	60	205	4
0/12/120/1920/5760	60	208	
0/12/120/1440/7200	60	186	3,5
0/12/120/1440/7200	60	186	3,5
0/12/120/2520/15120	60	152	2,5
0/12/120/2520/15120	60	150	2,5
0/12/120/2520/15120	60	115	2
1/0/4	4		4



London Vintage



INOX 18/10 / 4mm / Vintage



London Vintage

INOX 18/10 / 4mm / Vintage



- A **6805** CUCHILLO CHULETERO
steak knife, couteau steak, coltello bistecca, steakmesser
- B **6806** CUCHILLO MESA
table knife, couteau table, coltello tavola, tafelmesser
- C **6807** CUCHARA MESA
table spoon, cuillère table, cucchiaio tavola, tafellöffel
- D **6808** TENEDOR MESA
table fork, fourchette table, forchetta tavola, tafelgabel
- E **6809** PALA PESCADO
fish knife, couteau poisson, coltello pesce, fischmesser
- F **6810** TENEDOR PESCADO
fish fork, fourchette poisson, forchetta pesce, fischgabel
- G **6811** CUCHILLO POSTRE
dessert knife, couteau dessert, coltello frutta, dessertmesser
- H **6812** CUCHARA POSTRE
dessert spoon, cuillère dessert, cucchiaio frutta, dessertlöffel
- I **6813** TENEDOR POSTRE
dessert fork, fourchette dessert, forchetta frutta, dessertgabel
- J **6814** TENEDOR LUNCH
cake fork, fourchette gâteau, forchetta dolce, kuchengabel
- K **6815** CUCHARA CAFÉ
tea spoon, cuillère café, cucchiaio caffè, kaffeelöffel
- L **6816** CUCHARA MOKA
coffee/moka spoon, cuillère moka, cucchiaio moka, mokkalöffel

- 6817** 24 PIEZAS
24 pieces, écriin 24 pièces, bauletto 24 pz., 24 stück

	UE	MOQ	▶ mm	✂ mm
A	0/12/120/1920/5760	60	233	
B	0/12/120/1920/5760	60	228	
C	0/12/120/1440/7200	60	208	4
D	0/12/120/1440/7200	60	208	4
E	0/12/120/1440/7200	60	212	4
F	0/12/120/1440/7200	60	205	4
G	0/12/120/1920/5760	60	208	
H	0/12/120/1440/7200	60	186	3,5
I	0/12/120/1440/7200	60	186	3,5
J	0/12/120/2520/15120	60	152	2,5
K	0/12/120/2520/15120	60	150	2,5
L	0/12/120/2520/15120	60	115	2
	1/0/4	4		4



Violet

INOX 18/10 / 4mm / Mirror

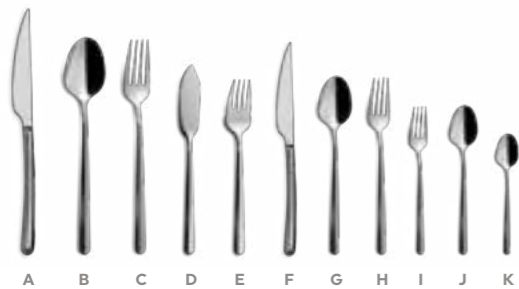

Tulip

INOX 18/10/ 4mm / Mirror

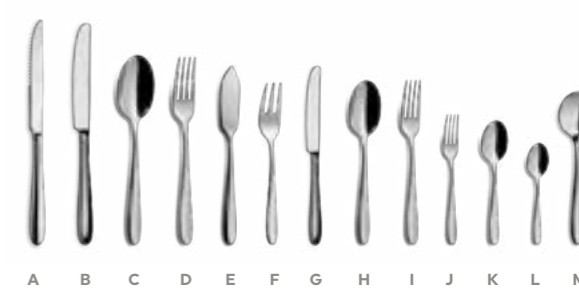

INOX STAINLESS STEEL 304

A	7046	CUCHILLO MESA table knife, couteau table, coltello tavola, tafelmesser
B	7047	CUCHARA MESA table spoon, cuillère table, cucchiaio tavola, tafellöffel
C	7048	TENEDOR MESA table fork, fourchette table, forchetta tavola, tafelgabel
D	7049	PALA PESCADO fish knife, couteau poisson, coltello pesce, fischmesser
E	7050	TENEDOR PESCADO fish fork, fourchette poisson, forchetta pesce, fischgabel
F	7051	CUCHILLO POSTRE dessert knife, couteau dessert, coltello frutta, dessertmesser
G	7052	CUCHARA POSTRE dessert spoon, cuillère dessert, cucchiaio frutta, dessertlöffel
H	7053	TENEDOR POSTRE dessert fork, fourchette dessert, forchetta frutta, dessertgabel
I	7054	TENEDOR LUNCH cake fork, fourchette gâteau, forchetta dolce, kuchengabel
J	7055	CUCHARA CAFÉ tea spoon, cuillère café, cucchiaio caffè, kaffeelöffel
K	7056	CUCHARA MOKA coffee/moka spoon, cuillère moka, cucchiaio moka, mokkalöffel

5962 24 PIEZAS
24 pieces, écriin 24 pièces, bauletto 24 pz., 24 stück

INOX STAINLESS STEEL 304

A	7033	CUCHILLO CHULETERO steak knife, couteau steak, coltello bistecca, steakmesser
B	7034	CUCHILLO MESA table knife, couteau table, coltello tavola, tafelmesser
C	7035	CUCHARA MESA table spoon, cuillère table, cucchiaio tavola, tafellöffel
D	7036	TENEDOR MESA table fork, fourchette table, forchetta tavola, tafelgabel
E	7037	PALA PESCADO fish knife, couteau poisson, coltello pesce, fischmesser
F	7038	TENEDOR PESCADO fish fork, fourchette poisson, forchetta pesce, fischgabel
G	7039	CUCHILLO POSTRE dessert knife, couteau dessert, coltello frutta, dessertmesser
H	7040	CUCHARA POSTRE dessert spoon, cuillère dessert, cucchiaio frutta, dessertlöffel
I	7041	TENEDOR POSTRE dessert fork, fourchette dessert, forchetta frutta, dessertgabel
J	7042	TENEDOR LUNCH cake fork, fourchette gâteau, forchetta dolce, kuchengabel
K	7043	CUCHARA CAFÉ tea spoon, cuillère café, cucchiaio caffè, kaffeelöffel
L	7044	CUCHARA MOKA coffee/moka spoon, cuillère moka, cucchiaio moka, mokkalöffel
M	7045	CUCHARA CONSOMÉ consommé spoon, cuillère consommé, cucchiaio zuppa, bouillonlöffel

5961 24 PIEZAS
24 pieces, écriin 24 pièces, bauletto 24 pz., 24 stück

UE	MOQ	▶ mm	✂ mm
0/12/120/1920/5760	60	244	
0/12/120/1920/5760	60	237	
0/12/120/1440/7200	60	207	4
0/12/120/1440/7200	60	206	4
0/12/120/1440/7200	60	195	3,5
0/12/120/1440/7200	60	176	3,5
0/12/120/1440/7200	60	174	3,5
0/12/120/1920/5760	60	209	
0/12/120/1440/7200	60	176	3,5
0/12/120/1440/7200	60	175	3,5
0/12/120/2520/15120	60	147	3
0/12/120/2520/15120	60	147	3
0/12/120/2520/15120	60	121	2,5
0/12/120/1920/5760	60	195	
0/12/120/1440/7200	60	178	3,5
0/12/120/1440/7200	60	179	3,5
0/12/120/2520/15120	60	142	3
0/12/120/2520/15120	60	135	3
0/12/120/2520/15120	60	111	2,5
0/12/120/1440/7200	60	166	3,5
1/0/4	4		4

Chef

INOX 18/10 /4mm / Mirror



B C D E F G H I J K L



A



A B C D E F G H I J K L M



Lotus

INOX 18/10 / 4mm / Mirror



A	3107	CUCHILLO CHULETERO SUTIL steak knife sutil, couteau steak sutil, coltello bistecca sutil, steakmesser sutil	0/6/60/720/3600	60	232	
B	5033	CUCHILLO MESA table knife, couteau table, coltello tavola, tafelmesser	0/12/120/1920/5760	60	235	
NEW C	11915	CUCHARA MESA table spoon, cuillère table, cucchiaio tavola, tafellöffel	0/12/120/1440/7200	60	200	4
NEW D	11916	TENEDOR MESA table fork, fourchette table, forchetta tavola, tafelgabel	0/12/120/1440/7200	60	200	4
E	3702	PALA PESCADO fish knife, couteau poisson, coltello pesce, fischmesser	0/12/120/1440/7200	60	205	3
F	3703	TENEDOR PESCADO fish fork, fourchette poisson, forchetta pesce, fischgabel	0/12/120/1440/7200	60	195	3
G	5034	CUCHILLO POSTRE dessert knife, couteau dessert, coltello frutta, dessertmesser	0/12/120/1920/5760	60	210	2,5
H	3704	CUCHARA POSTRE dessert spoon, cuillère dessert, cucchiaio frutta, dessertlöffel	0/12/120/1440/7200	60	180	2,5
I	3705	TENEDOR POSTRE dessert fork, fourchette dessert, forchetta frutta, dessertgabel	0/12/120/1440/7200	60	180	2,5
J	3706	TENEDOR LUNCH cake fork, fourchette gâteau, forchetta dolce, kuchengabel	0/12/120/2520/15120	60	148	2
K	3707	CUCHARA CAFÉ tea spoon, cuillère café, cucchiaio caffè, kaffeelöffel	0/12/120/2520/15120	60	140	2
L	3708	CUCHARA MOKA coffee/moka spoon, cuillère moka, cucchiaio moka, mokkalöffel	0/12/120/2520/15120	60	116	2

UE	MOQ	✂ mm	✂ mm
0/6/60/720/3600	60	232	
0/12/120/1920/5760	60	235	
0/12/120/1440/7200	60	200	4
0/12/120/1440/7200	60	200	4
0/12/120/1440/7200	60	205	3
0/12/120/1440/7200	60	195	3
0/12/120/1920/5760	60	210	2,5
0/12/120/1440/7200	60	180	2,5
0/12/120/1440/7200	60	180	2,5
0/12/120/2520/15120	60	148	2
0/12/120/2520/15120	60	140	2
0/12/120/2520/15120	60	116	2



A	6696	CUCHILLO CHULETERO steak knife, couteau steak, coltello bistecca, steakmesser	0/12/120/1920/5760	60	235	
B	3139	CUCHILLO MESA table knife, couteau table, coltello tavola, tafelmesser	0/12/120/1920/5760	60	225	
C	3141	CUCHARA MESA table spoon, cuillère table, cucchiaio tavola, tafellöffel	0/12/120/1440/7200	60	211	4
D	3142	TENEDOR MESA table fork, fourchette table, forchetta tavola, tafelgabel	0/12/120/1440/7200	60	211	4
E	3143	PALA PESCADO fish knife, couteau poisson, coltello pesce, fischmesser	0/12/120/1440/7200	60	206	3,5
F	3144	TENEDOR PESCADO fish fork, fourchette poisson, forchetta pesce, fischgabel	0/12/120/1440/7200	60	186	3,5
G	3145	CUCHILLO POSTRE dessert knife, couteau dessert, coltello frutta, dessertmesser	0/12/120/1920/5760	60	195	
H	3146	CUCHARA POSTRE dessert spoon, cuillère dessert, cucchiaio frutta, dessertlöffel	0/12/120/1440/7200	60	188	3,5
I	3147	TENEDOR POSTRE dessert fork, fourchette dessert, forchetta frutta, dessertgabel	0/12/120/1440/7200	60	186	3,5
J	3148	TENEDOR LUNCH cake fork, fourchette gâteau, forchetta dolce, kuchengabel	0/12/120/2520/15120	60	147	3
K	3149	CUCHARA CAFÉ tea spoon, cuillère café, cucchiaio caffè, kaffeelöffel	0/12/120/2520/15120	60	139	3
L	3150	CUCHARA MOKA coffee/moka spoon, cuillère moka, cucchiaio moka, mokkalöffel	0/12/120/2520/15120	60	114	2,5
M	3176	PALA MANTEQUILLA butter knife, couteau beurre, coltello burro, buttermesser	0/12/120/1440/7200	60	180	3

UE	MOQ	✂ mm	✂ mm
0/12/120/1920/5760	60	235	
0/12/120/1920/5760	60	225	
0/12/120/1440/7200	60	211	4
0/12/120/1440/7200	60	211	4
0/12/120/1440/7200	60	206	3,5
0/12/120/1440/7200	60	186	3,5
0/12/120/1920/5760	60	195	
0/12/120/1440/7200	60	188	3,5
0/12/120/1440/7200	60	186	3,5
0/12/120/2520/15120	60	147	3
0/12/120/2520/15120	60	139	3
0/12/120/2520/15120	60	114	2,5
0/12/120/1440/7200	60	180	3



5960	24 PIEZAS 24 pieces, écrin 24 pièces, bauletto 24 pz., 24 stück	1/0/4	4	3,5
-------------	--	-------	---	-----



INOX 18/10 / 3,5mm / Mirror



A B C D E F G H I J K L M N O P

INOX 18/10 / 3,5mm / Mirror



Añadimos cuchara CLÁSICA a la colección, dando la posibilidad de adaptar la gama Munich a distintos estilos.

We add CLASSIC spoon to the collection, giving the possibility to adapt the Munich range to different styles.

INOX
STAINLESS
STEEL
304

- A **6511** CUCHILLO CHULETERO
steak knife, couteau steak, coltello bistecca, steakmesser
- B **6512** CUCHILLO MESA
table knife, couteau table, coltello tavola, tafelmesser
- C **6513** CUCHARA MESA
table spoon, cuillère table, cucchiaio tavola, tafellöffel
- NEW** D **11935** CUCHARA MESA CLASICA
classic table spoon, cuillère table classic, cucchiaio tavola classic, tafellöffel classic
- E **6514** TENEDOR MESA
table fork, fourchette table, forchetta tavola, tafelgabel
- F **6515** PALA PESCADO
fish knife, couteau poisson, coltello pesce, fischmesser
- G **6516** TENEDOR PESCADO
fish fork, fourchette poisson, forchetta pesce, fischgabel
- H **6517** CUCHILLO POSTRE
dessert knife, couteau dessert, coltello frutta, dessertmesser
- I **6518** CUCHARA POSTRE
dessert spoon, cuillère dessert, cucchiaio frutta, dessertlöffel
- NEW** J **11936** CUCHARA POSTRE CLASICA
classic dessert spoon, cuillère dessert classic, cucchiaio frutta classic, dessertlöffel classic
- K **6519** TENEDOR POSTRE
dessert fork, fourchette dessert, forchetta frutta, dessertgabel
- L **6520** TENEDOR LUNCH
cake fork, fourchette gâteau, forchetta dolce, kuchengabel
- M **6521** CUCHARA CAFÉ
tea spoon, cuillère café, cucchiaio caffè, kaffeelöffel
- NEW** N **11937** CUCHARA CAFÉ CLASICA
classic tea spoon, cuillère café classic, cucchiaio caffè classic, kaffeelöffel classic
- O **6522** CUCHARA MOKA
coffee/moka spoon, cuillère moka, cucchiaio moka, mokkalöffel
- NEW** P **11938** CUCHARA MOKA CLASICA
classic coffee/moka spoon, cuillère moka classic, cucchiaio moka classic, mokkalöffel classic

6523 24 PIEZAS
24 pieces, écrin 24 pièces, bauletto 24 pz., 24 stück

UE	MOQ	▶ mm	✕ mm
0/12/120/1920/5760	60	237	
0/12/120/1920/5760	60	235	
0/12/120/1440/7200	60	210	3,5
0/12/120/1440/7200	60	210	3,5
0/12/120/1440/7200	60	209	3,5
0/12/120/1440/7200	60	210	3
0/12/120/1440/7200	60	207	3
0/12/120/1920/5760	60	209	
0/12/120/1440/7200	60	182	3
0/12/120/1440/7200	60	185	3
0/12/120/1440/7200	60	186	3
0/12/120/2520/15120	60	153	2,5
0/12/120/2520/15120	60	150	2,5
0/12/120/2520/15120	60	150	2,5
0/12/120/2520/15120	60	115	2,5
0/12/120/2520/15120	60	115	2,5
1/0/4	4		3,5



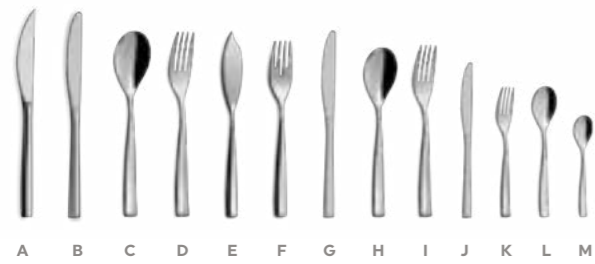

INOX
STAINLESS
STEEL
304

A	0764	CUCHILLO CHULETERO steak knife, couteau steak, coltello bistecca, steakmesser	0/12/120/1920/5760	60	223	
B	0268	CUCHILLO MESA table knife, couteau table, coltello tavola, tafelmesser	0/12/120/1920/5760	60	221	
C	2736	CUCHARA MESA table spoon, cuillère table, cucchiaio tavola, tafellöffel	0/12/120/1440/7200	60	200	3,5
D	2735	TENEDOR MESA table fork, fourchette table, forchetta tavola, tafelgabel	0/12/120/1440/7200	60	200	3,5
E	2742	PALA PESCADO fish knife, couteau poisson, coltello pesce, fischmesser	0/12/120/1440/7200	60	200	2,5
F	2741	TENEDOR PESCADO fish fork, fourchette poisson, forchetta pesce, fischgabel	0/12/120/1440/7200	60	190	2,5
G	5807	CUCHILLO POSTRE dessert knife, couteau dessert, coltello frutta, dessertmesser	0/12/120/1920/5760	60	202	
H	2740	CUCHARA POSTRE dessert spoon, cuillère dessert, cucchiaio frutta, dessertlöffel	0/12/120/1440/7200	60	183	2,5
I	2738	TENEDOR POSTRE dessert fork, fourchette dessert, forchetta frutta, dessertgabel	0/12/120/1440/7200	60	185	2,5
J	5814	CUCHILLO LUNCH cake knife, couteau gâteau, coltello dolce, kuchenmesser	0/12/120/1920/5760	60	167	
K	2745	TENEDOR LUNCH cake fork, fourchette gâteau, forchetta dolce, kuchengabel	0/12/120/2520/15120	60	140	2,5
L	2743	CUCHARA CAFÉ tea spoon, cuillère café, cucchiaio caffè, kaffeelöffel	0/12/120/2520/15120	60	140	2,5
M	2744	CUCHARA MOKA coffee/moka spoon, cuillère moka, cucchiaio moka, mokkalöffel	0/12/120/2520/15120	60	110	2,5

2797 **24 PIEZAS**
24 pieces, écriin 24 pièces, bauletto 24 pz., 24 stück

UE	MOQ	▶ mm	✂ mm
0/12/120/1920/5760	60	223	
0/12/120/1920/5760	60	221	
0/12/120/1440/7200	60	200	3,5
0/12/120/1440/7200	60	200	3,5
0/12/120/1440/7200	60	200	2,5
0/12/120/1440/7200	60	190	2,5
0/12/120/1920/5760	60	202	
0/12/120/1440/7200	60	183	2,5
0/12/120/1440/7200	60	185	2,5
0/12/120/1920/5760	60	167	
0/12/120/2520/15120	60	140	2,5
0/12/120/2520/15120	60	140	2,5
0/12/120/2520/15120	60	110	2,5
1/0/4	4		3,5

INOX
STAINLESS
STEEL
304

A	5821	CUCHILLO MESA table knife, couteau table, coltello tavola, tafelmesser	0/12/120/1920/5760	60	229	
B	5822	CUCHARA MESA table spoon, cuillère table, cucchiaio tavola, tafellöffel	0/12/120/1440/7200	60	205	3,5
C	5823	TENEDOR MESA table fork, fourchette table, forchetta tavola, tafelgabel	0/12/120/1440/7200	60	205	3,5
D	5824	PALA PESCADO fish knife, couteau poisson, coltello pesce, fischmesser	0/12/120/1440/7200	60	215	3,5
E	5825	TENEDOR PESCADO fish fork, fourchette poisson, forchetta pesce, fischgabel	0/12/120/1440/7200	60	195	3,5
F	5826	CUCHILLO POSTRE dessert knife, couteau dessert, coltello frutta, dessertmesser	0/12/120/1920/5760	60	200	
G	5827	CUCHARA POSTRE dessert spoon, cuillère dessert, cucchiaio frutta, dessertlöffel	0/12/120/1440/7200	60	190	3,5
H	5828	TENEDOR POSTRE dessert fork, fourchette dessert, forchetta frutta, dessertgabel	0/12/120/1440/7200	60	185	3,5
I	5829	TENEDOR LUNCH cake fork, fourchette gâteau, forchetta dolce, kuchengabel	0/12/120/2520/15120	60	140	2,5
J	5830	CUCHARA CAFÉ tea spoon, cuillère café, cucchiaio caffè, kaffeelöffel	0/12/120/2520/15120	60	147	2,5
K	5831	CUCHARA MOKA coffee/moka spoon, cuillère moka, cucchiaio moka, mokkalöffel	0/12/120/2520/15120	60	110	2
L	3158	CUCHARA CONSOMÉ consommé spoon, cuillère consommé, cucchiaio zuppa, bouillonlöffel	0/12/120/1440/7200	60	180	2,5
M	0463	CAZO SOPA soup ladle, louche à potage, mestolo, suppenkelle	1/10/50/150/750	10	280	3,5
N	0464	CUCHARA ENSALADA salad spoon, cuillère à servir salade, cucchiaio servire, salatlöffel	1/10/50/800/4000	10	275	3,5
O	0465	TENEDOR ENSALADA salad fork, fourchette à servir salade, forchetta servire, salatgabel	1/10/50/800/4000	10	275	3,5
P	0466	PALA REPOSTERÍA cake server, pelle à tarte, pala torta, tortenheber	1/10/50/600/2400	10	260	3,5
Q	0467	CAZO SALSA sauce ladle, cuillère à sauce, mestolino salsa, soßenkelle	1/10/50/800/4000	10	180	3,5

2900 **24 PIEZAS**
24 pieces, écriin 24 pièces, bauletto 24 pz., 24 stück

UE	MOQ	▶ mm	✂ mm
0/12/120/1920/5760	60	229	
0/12/120/1440/7200	60	205	3,5
0/12/120/1440/7200	60	205	3,5
0/12/120/1440/7200	60	215	3,5
0/12/120/1440/7200	60	195	3,5
0/12/120/1920/5760	60	200	
0/12/120/1440/7200	60	190	3,5
0/12/120/1440/7200	60	185	3,5
0/12/120/2520/15120	60	140	2,5
0/12/120/2520/15120	60	147	2,5
0/12/120/2520/15120	60	110	2
0/12/120/1440/7200	60	180	2,5
1/10/50/150/750	10	280	3,5
1/10/50/800/4000	10	275	3,5
1/10/50/800/4000	10	275	3,5
1/10/50/600/2400	10	260	3,5
1/10/50/800/4000	10	180	3,5
1/0/4	4		3,5

North XL

INOX 18/10 / 3mm / Mirror



North XL

INOX 18/10 / 3mm / Mirror

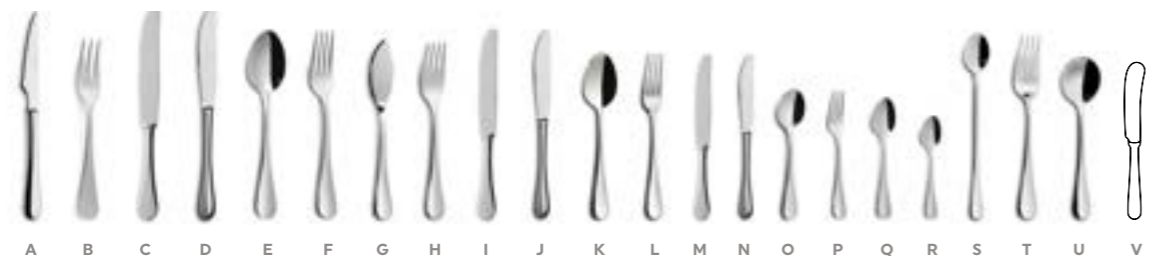

INOX STAINLESS STEEL 304

- A **4402** CUCHILLO CHULETERO
steak knife, couteau steak, coltello bistecca, steakmesser
- B **5525** TENEDOR CHULETERO
steak fork, fourchette steak, forchetta bistecca, steakgabel
- NEW** C **11923** CUCHILLO MESA CLASICO
classic table knife, couteau table classic, coltello tavola classic, tafelmesser classic
- !** D **4535** CUCHILLO MESA
table knife, couteau table, coltello tavola, tafelmesser
- UP** E **4536** CUCHARA MESA
table spoon, cuillère table, cucchiaio tavola, tafellöffel
- UP** F **4537** TENEDOR MESA
table fork, fourchette table, forchetta tavola, tafelgabel
- G **5376** PALA PESCADO
fish knife, couteau poisson, coltello pesce, fischmesser
- H **5377** TENEDOR PESCADO
fish fork, fourchette poisson, forchetta pesce, fischgabel
- NEW** I **11924** CUCHILLO POSTRE CLASICO
classic dessert knife, couteau dessert classic, coltello frutta classic, dessertmesser classic
- !** J **4538** CUCHILLO POSTRE
dessert knife, couteau dessert, coltello frutta, dessertmesser
- K **5378** CUCHARA POSTRE
dessert spoon, cuillère dessert, cucchiaio frutta, dessertlöffel
- L **5379** TENEDOR POSTRE
dessert fork, fourchette dessert, forchetta frutta, dessertgabel
- NEW** M **11925** CUCHILLO LUNCH CLASICO
classic cake knife, couteau gâteau classic, coltello dolce classic, kuchenmesser classic
- !** N **5015** CUCHILLO LUNCH
cake knife, couteau gâteau, coltello dolce, kuchenmesser
- UP** O **3846** CUCHARA TÉ
iced tea spoon, cuillère à té, cucchiaio the, cocktaillöffel
- NEW** P **11926** TENEDOR LUNCH
cake fork, fourchette gâteau, forchetta dolce, kuchengabel
- UP** Q **3948** CUCHARA CAFÉ
tea spoon, cuillère café, cucchiaio caffè, kaffeeöffel
- UP** R **3949** CUCHARA MOKA
coffee/moka spoon, cuillère moka, cucchiaio moka, mokkalöffel
- S **4993** CUCHARA REFRESCO
soda spoon, cuillère mazagran, cucchiaio bibita, longdrinklöffel
- T **5533** TENEDOR ARROZ
rice fork, fourchette à riz, forchetta riso, reisgabel
- U **3154** CUCHARA CONSOMÉ
consommé spoon, cuillère consommé, cucchiaio zuppa, bouillonlöffel
- NEW** V **12030** PALA MANTEQUILLA
butter knife, cuillère consommé, cucchiaio zuppa, bouillonlöffel

UE	MOQ	✂ mm	✂ mm
0/12/120/1920/5760	60	228	
0/12/120/1440/7200	60	202	3
0/12/120/1440/7200	60	240	
0/12/120/1920/5760	60	240	
0/12/120/1440/7200	60	209	3
0/12/120/1440/7200	60	210	3
0/12/120/1440/7200	60	200	3
0/12/120/1440/7200	60	195	3
0/12/120/1920/5760	60	216	
0/12/120/1920/5760	60	212	
0/12/120/1440/7200	60	178	2,5
0/12/120/1440/7200	60	183	2,5
0/12/120/1920/5760	60	176	
0/12/120/1920/5760	60	178	
0/12/120/2520/15120	60	145	2
0/12/120/2520/15120	60	148	2
0/12/120/2520/15120	60	138	2
0/12/120/2520/15120	60	117	2
0/12/120/1440/7200	60	207	2
0/12/120/1440/7200	60	205	2,5
0/12/120/1440/7200	60	180	2,5
0/12/120/1440/7200	60	176	3



! BAJO PEDIDO
ON DEMAND

7119 24 PIEZAS
24 pieces, écrin 24 pièces, bauletto 24 pz., 24 Stück

€	UE	MOQ	✂ mm	✂ mm
3,28 €	1/0/4	4		
2,92 €				
95				



North M

INOX 18/10 / 2,5mm / Mirror



North S

INOX 18/10 / 2mm / Mirror

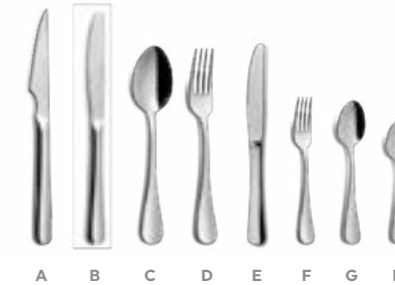

INOX
STAINLESS
STEEL
304

- A **6359** CUCHILLO MESA GRANDE
long table knife, grande couteau table, coltello tavola grande, tafelmesser lang
- B **4007** CUCHARA MESA GRANDE
table spoon long, grande cuillère table, cucchiaio tavola grande, tafellöffel lang
- C **4008** TENEDOR MESA GRANDE
long table fork, grande fourchette table, forchetta tavola grande, tafelgabel lang
- D **3948** CUCHARA CAFÉ
tea spoon, cuillère café, cucchiaio caffè, kaffeelöffel

7120 24 PIEZAS
24 pieces, écrin 24 pièces, bauletto 24 pz., 24 stück

UE **MOQ** **▶ mm** **✂ mm**

0/12/120/1920/5760	60	228	
0/12/120/1440/7200	60	198	2,5
0/12/120/1440/7200	60	198	2,5
0/12/120/2520/15120	60	135	2



INOX
STAINLESS
STEEL
304

- A **5631** CUCHILLO CHULETERO
steak knife, couteau steak, coltello bistecca, steakmesser
- B **0094** CUCHILLO MESA
table knife, couteau table, coltello tavola, tafelmesser
- C **3940** CUCHARA MESA
table spoon, cuillère table, cucchiaio tavola, tafellöffel
- D **3941** TENEDOR MESA
table fork, fourchette table, forchetta tavola, tafelgabel
- E **0099** CUCHILLO POSTRE
dessert knife, couteau dessert, coltello frutta, dessertmesser
- F **3947** TENEDOR LUNCH
cake fork, fourchette gâteau, forchetta dolce, kuchengabel
- G **5567** CUCHARA CAFÉ
tea spoon, cuillère café, cucchiaio caffè, kaffeelöffel
- H **5568** CUCHARA MOKA
coffee/moka spoon, cuillère moka, cucchiaio moka, mokkalöffel

7122 24 PIEZAS
24 pieces, écrin 24 pièces, bauletto 24 pz., 24 stück

UE **MOQ** **▶ mm** **✂ mm**

0/12/120/1920/5760	60	230	
0/12/120/1920/5760	60	225	
0/12/120/1440/7200	60	193	1,8
0/12/120/1440/7200	60	190	2
0/12/120/1920/5760	60	195	
0/12/120/2520/15120	60	143	1,5
0/12/120/2520/15120	60	140	1,5
0/12/120/2520/15120	60	120	1,2



Baguette XL

INOX 18/10 / 3mm / Mirror



Baguette XL

INOX 18/10 / 3mm / Mirror



INOX STAINLESS STEEL 304

- A **3526** CUCHILLO CHULETERO
steak knife, couteau steak, coltello bistecca, steakmesser
- NEW** B **11923** CUCHILLO MESA CLASICO
classic table knife, couteau table classic, coltello tavola classic, tafelmesser classic
- C **5013** CUCHILLO MESA
table knife, couteau table, coltello tavola, tafelmesser
- UP** D **4365** CUCHARA MESA
table spoon, cuillère table, cucchiaio tavola, tafellöffel
- UP** E **4366** TENEDOR MESA
table fork, fourchette table, forchetta tavola, tafelgabel
- F **5297** PALA PESCADO
fish knife, couteau poisson, coltello pesce, fischmesser
- G **5298** TENEDOR PESCADO
fish fork, fourchette poisson, forchetta pesce, fischgabel
- NEW** H **11924** CUCHILLO POSTRE CLASICO
classic dessert knife, couteau dessert classic, coltello frutta classic, dessertmesser classic
- I **4367** CUCHILLO POSTRE
dessert knife, couteau dessert, coltello frutta, dessertmesser
- J **5299** CUCHARA POSTRE
dessert spoon, cuillère dessert, cucchiaio frutta, dessertlöffel
- K **5300** TENEDOR POSTRE
dessert fork, fourchette dessert, forchetta frutta, dessertgabel
- NEW** L **11925** CUCHILLO LUNCH CLASICO
classic cake knife, couteau gâteau classic, coltello dolce classic, kuchenmesser classic
- M **5014** CUCHILLO LUNCH
cake knife, couteau gâteau, coltello dolce, kuchenmesser
- UP** N **3877** CUCHARA TÉ
tea spoon, cuillère à té, cucchiaio the, cocktaillöffel
- NEW** O **11927** TENEDOR LUNCH
cake fork, fourchette gâteau, forchetta dolce, kuchengabel
- UP** P **5302** CUCHARA CAFÉ
tea spoon, cuillère café, cucchiaio caffè, kaffeelöffel
- UP** Q **5303** CUCHARA MOKA
coffee/moka spoon, cuillère moka, cucchiaio moka, mokkalöffel
- R **3155** CUCHARA CONSOMÉ
consommé spoon, cuillère consommé, cucchiaio zuppa, bouillonlöffel

	UE	MOQ	▶ mm	✂ mm
A	0/12/120/1920/5760	60	230	
B	0/12/120/1920/5760	60	240	
C	0/12/120/1920/5760	60	240	
D	0/12/120/1440/7200	60	209	3
E	0/12/120/1440/7200	60	210	3
F	0/12/120/1440/7200	60	200	2,5
G	0/12/120/1440/7200	60	195	2,5
H	0/12/120/1920/5760	60	216	
I	0/12/120/1920/5760	60	178	
J	0/12/120/1440/7200	60	185	2,5
K	0/12/120/1440/7200	60	183	2,5
L	0/12/120/1920/5760	60	176	
M	0/12/120/1920/5760	60	138	
N	0/12/120/2520/15120	60	145	2
O	0/12/120/2520/15120	60	148	2
P	0/12/120/2520/15120	60	138	2
Q	0/12/120/2520/15120	60	117	2
R	0/12/120/1440/7200	60	180	2,5



4883 24 PIEZAS
24 pieces, écrin 24 pièces, bauletto 24 pz., 24 stück

UE 1/0/4
MOQ 4
▶ mm ✂ mm 3



Baguette S

INOX 18/10 / 2mm / Mirror

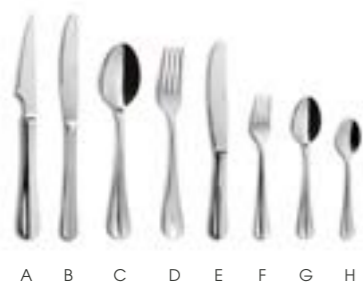

INOX
STAINLESS
STEEL
304

- A **1283** CUCHILLO CHULETERO
steak knife, couteau steak, coltello bistecca, steakmesser
- B **3522** CUCHILLO MESA
table knife, couteau table, coltello tavola, tafelmesser
- C **4377** CUCHARA MESA
table spoon, cuillère table, cucchiaio tavola, tafellöffel
- D **4378** TENEDOR MESA
table fork, fourchette table, forchetta tavola, tafelgabel
- E **3523** CUCHILLO POSTRE
dessert knife, couteau dessert, coltello frutta, dessertmesser
- F **4383** TENEDOR LUNCH
cake fork, fourchette gâteau, forchetta dolce, kuchengabel
- G **4384** CUCHARA CAFÉ
tea spoon, cuillère café, cucchiaio caffè, kaffeelöffel
- H **4385** CUCHARA MOKA
coffee/moka spoon, cuillère moka, cucchiaio moka, mokkalöffel

7121 24 PIEZAS
24 pieces, écriin 24 pièces, bauletto 24 pz, 24 stück

UE	MOQ	▶ mm	✂ mm
0/12/120/1920/5760	60	223	
0/12/120/1920/5760	60	225	
0/12/120/1440/7200	60	193	1,8
0/12/120/1440/7200	60	190	2
0/12/120/1920/5760	60	196	
0/12/120/2520/15120	60	143	1,5
0/12/120/2520/15120	60	140	1,5
0/12/120/2520/15120	60	120	1,2
1/0/4	4		2



UP
GRADE

Actualización / Upgrade

NORTH XL / BAGUETTE XL / INGLÉS XL



2024



2025

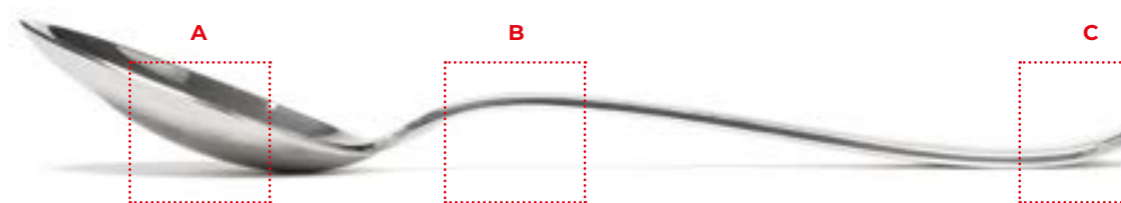

Profundidad pala.
Shovel depth.

Curvatura cuello.
Neck curvature.

Curvatura talón.
Heel curvature

PROFUNDIDAD DE LA PALA / SHOVEL DEPTH

Se ha aumentado la profundidad en la pala, permitiendo contener más líquido o alimentos y proporcionando así una mayor comodidad al usuario al permanecer la comida más estable dentro de la cuchara, sin derramarse.

The depth of the scoop has been increased, allowing it to hold more liquid or food and thus providing greater comfort to the user as the food remains more stable inside the spoon, without spilling.

CURVATURA DEL CUELLO / NECK CURVATURE

Diseñada para mejorar la ergonomía. Facilita el movimiento natural de la mano al llevar la comida a la boca, haciendo que el gesto sea más cómodo y fluido.

Designed to improve ergonomics. Facilitates the natural movement of the hand when bringing food to the mouth, making the gesture more comfortable and fluid.

CURVATURA DEL TALÓN / HEEL CURVATURE

Curvatura del talón más pronunciada que mejora el balance de la cuchara en la mano dando una sensación de mayor estabilidad.

More pronounced heel curvature improves the balance of the scoop in the hand giving a more stable feel.

Inglés XL

INOX 18/10 / 3mm / Mirror



Inglés XL

INOX 18/10 / 3mm / Mirror

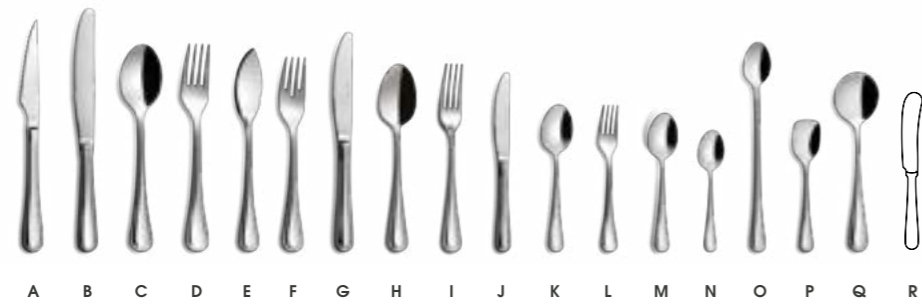

INOX
STAINLESS
STEEL
304

- A **5952** CUCHILLO CHULETERO
steak knife, couteau steak, coltello bistecca, steakmesser
- NEW** B **11917** CUCHILLO MESA CLASICO
classic table knife, couteau table classic, coltello tavola classic, tafelmesser classic
- NEW** C **11918** CUCHARA MESA
table spoon, cuillère table, cucchiaio tavola, tafellöffel
- NEW** D **11919** TENEDOR MESA
table fork, fourchette table, forchetta tavola, tafelgabel
- E **5372** PALA PESCADO
fish knife, couteau poisson, coltello pesce, fischmesser
- F **5373** TENEDOR PESCADO
fish fork, fourchette poisson, forchetta pesce, fischgabel
- NEW** G **11920** CUCHILLO POSTRE CLASICO
classic dessert knife, couteau dessert classic, coltello frutta classic, dessertmesser classic
- H **5374** CUCHARA POSTRE
dessert spoon, cuillère dessert, cucchiaio frutta, dessertlöffel
- I **5375** TENEDOR POSTRE
dessert fork, fourchette dessert, forchetta frutta, dessertgabel
- NEW** J **11921** CUCHILLO LUNCH CLASICO
classic cake knife, couteau gâteau classic, coltello dolce classic, kuchenmesser classic
- UP** K **5309** CUCHARA TÉ
tea spoon, cuillère à té, cucchiaio the, cocktaillöffel
- NEW** L **11922** TENEDOR LUNCH
cake fork, fourchette gâteau, forchetta dolce, kuchengabel
- UP** M **5437** CUCHARA CAFÉ
tea spoon, cuillère café, cucchiaio caffè, kaffeelöffel
- UP** N **5438** CUCHARA MOKA
coffee/moka spoon, cuillère moka, cucchiaio moka, mokkalöffel
- O **4508** CUCHARA REFRESCO
soda spoon, cuillère mazagan, cucchiaio bibita, longdrinklöffel
- P **4018** CUCHARA HELADO
ice cream spoon, cuillère à glace, cucchiaio gelato, eiscremelöffel
- Q **4019** CUCHARA CONSOMÉ
consommé spoon, cuillère consommé, cucchiaio zuppa, bouillonlöffel
- NEW** R **12029** PALA MANTEQUILLA
butter knife, cuillère consommé, cucchiaio zuppa, bouillonlöffel

	UE	MOQ	▶ mm	✂ mm
A	0/12/120/1920/5760	60	228	
B	0/12/120/1920/5760	60	240	
C	0/12/120/1440/7200	60	209	3
D	0/12/120/1440/7200	60	210	3
E	0/12/120/1440/7200	60	200	2,5
F	0/12/120/1440/7200	60	195	2,5
G	0/12/120/1440/7200	60	217	
H	0/12/120/1440/7200	60	178	2,5
I	0/12/120/1440/7200	60	183	2,5
J	0/12/120/2520/15120	60	177	
K	0/12/120/1440/7200	60	145	2
L	0/12/120/2520/15120	60	148	2
M	0/12/120/2520/15120	60	138	2
N	0/12/120/2520/15120	60	117	2
O	0/12/120/1440/7200	60	207	2
P	0/12/120/2520/15120	60	130	2
Q	0/12/120/1440/7200	60	180	2,5
R	0/12/120/2520/15120	60	176	



4881 24 PIEZAS
24 pieces, écri 24 pièces, bauletto 24 pz., 24 stück

	UE	MOQ	▶ mm	✂ mm
	1/0/4	4		2,5



Inglés M

INOX 18/10 / 2,5mm / Mirror



Inglés S

INOX 18/10 / 2mm / Mirror

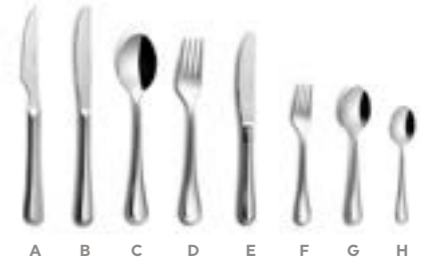

INOX STAINLESS STEEL 304

- A **6360** CUCHILLO MESA GRANDE
long table knife, grande couteau table, coltello tavola grande, tafelmesser lang
- B **4009** CUCHARA MESA GRANDE
long table spoon, grande cuillère table, cucchiaio tavola grande, tafellöffel lang
- C **4010** TENEDOR MESA GRANDE
long table fork, grande fourchette table, forchetta tavola grande, tafelgabel lang
- D **5437** CUCHARA CAFÉ
tea spoon, cuillère café, cucchiaio caffè, kaffeelöffel

7123 24 PIEZAS
24 pieces, écrin 24 pièces, bauletto 24 pz., 24 stück

UE **MOQ** **▶ mm** **✂ mm**

0/12/120/1920/5760	60	228	
0/12/120/1440/7200	60	198	2,5
0/12/120/1440/7200	60	198	2,5
0/12/120/2520/15120	60	137	2



INOX STAINLESS STEEL 304

- A **2396** CUCHILLO CHULETERO
steak knife, couteau steak, coltello bistecca, steakmesser
- B **2338** CUCHILLO MESA
table knife, couteau table, coltello tavola, tafelmesser
- C **2339** CUCHARA MESA
table spoon, cuillère table, cucchiaio tavola, tafellöffel
- D **2340** TENEDOR MESA
table fork, fourchette table, forchetta tavola, tafelgabel
- E **2511** CUCHILLO POSTRE
dessert knife, couteau dessert, coltello frutta, dessertmesser
- F **2341** TENEDOR LUNCH
cake fork, fourchette gâteau, forchetta dolce, kuchengabel
- G **2342** CUCHARA CAFÉ
tea spoon, cuillère café, cucchiaio caffè, kaffeelöffel
- H **2343** CUCHARA MOKA
coffee/moka spoon, cuillère moka, cucchiaio moka, mokkalöffel

7124 24 PIEZAS
24 pieces, écrin 24 pièces, bauletto 24 pz., 24 stück

UE **MOQ** **▶ mm** **✂ mm**

0/12/120/1920/5760	60	223	
0/12/120/1920/5760	60	222	
0/12/120/1440/7200	60	193	1,8
0/12/120/1440/7200	60	190	2
0/12/120/1920/5760	60	196	
0/12/120/2520/15120	60	143	1,5
0/12/120/2520/15120	60	140	1,5
0/12/120/2520/15120	60	120	1,2





INOX
STAINLESS
STEEL
304

A	5307	CUCHILLO CHULETERO steak knife, couteau steak, coltello bistecca, steakmesser
B	4777	CUCHILLO MESA table knife, couteau table, coltello tavola, tafelmesser
C	4714	CUCHARA MESA table spoon, cuillère table, cucchiaio tavola, tafellöffel
D	4715	TENEDOR MESA table fork, fourchette table, forchetta tavola, tafelgabel
E	4716	PALA PESCADO fish knife, couteau poisson, coltello pesce, fischmesser
F	4717	TENEDOR PESCADO fish fork, fourchette poisson, forchetta pesce, fischgabel
G	4778	CUCHILLO POSTRE dessert knife, couteau dessert, coltello frutta, dessertmesser
H	4721	CUCHARA POSTRE dessert spoon, cuillère dessert, cucchiaio frutta, dessertlöffel
I	4722	TENEDOR POSTRE dessert fork, fourchette dessert, forchetta frutta, dessertgabel
J	4718	TENEDOR LUNCH cake fork, fourchette gâteau, forchetta dolce, kuchengabel
K	4719	CUCHARA CAFÉ tea spoon, cuillère café, cucchiaio caffè, kaffeelöffel
L	4720	CUCHARA MOKA coffee/moka spoon, cuillère moka, cucchiaio moka, mokkalöffel
M	4781	CAZO SOPA soup ladle, louche à potage, mestolo, suppenkelle
N	4780	CUCHARA ENSALADA salad spoon, cuillère à servir salade, cucchiaio servire, salatlöffel
O	4779	TENEDOR ENSALADA salad fork, fourchette à servir salade, forchetta servire, salatgabel
P	4784	PALA REPOSTERÍA cake server, pelle à tarte, pala torta, tortenheber
Q	4783	CAZO SALSA sauce ladle, cuillère à sauce, mestolino salsa, soßenkelle

UE	MOQ	◀ mm	✂ mm
0/12/120/1920/5760	60	228	
0/12/120/1920/5760	60	240	
0/12/120/1440/7200	60	210	2,5
0/12/120/1440/7200	60	210	2,5
0/12/120/1440/7200	60	210	2,5
0/12/120/1440/7200	60	196	2,5
0/12/120/1920/5760	60	210	
0/12/120/1440/7200	60	191	2,5
0/12/120/1440/7200	60	195	2,5
0/12/120/2520/15120	60	160	2
0/12/120/2520/15120	60	155	2
0/12/120/2520/15120	60	133	1,8
1/10/50/150/750	10	280	2,5
1/10/50/800/4000	10	240	2,5
1/10/50/800/4000	10	240	2,5
1/10/50/800/2400	10	240	2,5
1/10/50/800/4000	10	170	2,7



9817 24 PIEZAS
24 pièces. écriin 24 pièces. bauletto 24 pz., 24 stück

UE	MOQ	◀ mm	✂ mm
1/0/4	4		2,5



Barcelona

INOX 18/10 / 3,5mm / Mirror



Barcelona

INOX 18/10 / 3,5mm / Mirror



INOX STAINLESS STEEL 304

- A **0764** CUCHILLO CHULETERO
steak knife, couteau steak, coltello bistecca, steakmesser
- B **0268** CUCHILLO MESA
table knife, couteau table, coltello tavola, tafelmesser
- NEW** C **11913** CUCHARA MESA
table spoon, cuillère table, cucchiaio tavola, tafellöffel
- NEW** D **11914** TENEDOR MESA
table fork, fourchette table, forchetta tavola, tafelgabel
- E **5805** PALA PESCADO
fish knife, couteau poisson, coltello pesce, fischmesser
- F **5806** TENEDOR PESCADO
fish fork, fourchette poisson, forchetta pesce, fischgabel
- G **5807** CUCHILLO POSTRE
dessert knife, couteau dessert, coltello frutta, dessertmesser
- H **5808** CUCHARA POSTRE
dessert spoon, cuillère dessert, cucchiaio frutta, dessertlöffel
- I **5809** TENEDOR POSTRE
dessert fork, fourchette dessert, forchetta frutta, dessertgabel
- J **5814** CUCHILLO LUNCH
cake knife, couteau gâteau, coltello dolce, kuchenmesser
- K **5810** TENEDOR LUNCH
cake fork, fourchette gâteau, forchetta dolce, kuchengabel
- L **5811** CUCHARA CAFÉ
tea spoon, cuillère café, cucchiaio caffè, kaffeelöffel
- M **5812** CUCHARA MOKA
coffee/moka spoon, cuillère moka, cucchiaio moka, mokkalöffel
- N **5815** PALA MANTEQUILLA
butter knife, couteau beurre, coltello burro, buttermesser
- O **3152** CUCHARA REFRESCO
soda spoon, cuillère mazagran, cucchiaio bibita, longdrinklöffel
- P **3153** CUCHARA CONSOMÉ
consommé spoon, cuillère consommé, cucchiaio zuppa, bouillonlöffel
- Q **0470** CAZO SOPA
soup ladle, louche à potage, mestolo, suppenkelle
- R **0471** CUCHARA ENSALADA
salad spoon, cuillère à servir salade, cucchiaio servire, salatlöffel
- S **0472** TENEDOR ENSALADA
salad fork, fourchette à servir salade, forchetta servire, salatgabel
- T **0473** PALA LASAÑA
lasagna server, pelle à lasagne, pala lasagna, lasagneheber
- U **0474** CAZO SALSA
sauce ladle, cuillère à sauce, mestolino salsa, soßenkelle

UE	MOQ	mm	mm
0/12/120/1920/5760	60	223	
0/12/120/1920/5760	60	221	
0/12/120/1440/7200	60	200	3,5
0/12/120/1440/7200	60	200	3,5
0/12/120/1440/7200	60	205	2,5
0/12/120/1440/7200	60	190	2,5
0/12/120/1920/5760	60	202	
0/12/120/1440/7200	60	183	2,5
0/12/120/1440/7200	60	185	2,5
0/12/120/1920/5760	60	167	
0/12/120/2520/15120	60	140	2,5
0/12/120/2520/15120	60	140	2,5
0/12/120/2520/15120	60	110	2,5
0/12/120/1440/7200	60	165	2,5
0/12/120/1440/7200	60	200	2,5
0/12/120/1440/7200	60	180	2,5
1/10/50/150/750	10	268	3
1/10/50/800/4000	10	270	3
1/10/50/800/4000	10	265	3
1/10/50/600/2400	10	235	3
1/10/50/800/4000	10	180	3



5818 24 PIEZAS
24 pieces, écrin 24 pièces, bauletto 24 pz., 24 stück

UE 1/0/4
MOQ 4
mm 3
mm 3





Soporte cubiertos Sakura
Sakura cutlery holder
Panier à couverts Sakura
Supporto coperte Sakura
Besteckhalter Sakura



INOX
STAINLESS
STEEL
304

REF.	W _(mm)	H _(mm)	€	UE / MOQ
7869	80	8,5		0-6-60-1440-4320 / 60



Reposacubiertos Atlántida
Atlántida cutlery holder
Panier à couverts Atlantida
Porta posate Atlantida
Besteckhalter Atlantida



INOX
STAINLESS
STEEL
304

REF.	W _(mm)	H _(mm)	€	UE / MOQ
10431	190	1,5		1-4--48-624-1248 / 4



Reposacubiertos Ice Kyoto
Kyoto ice cutlery holder
Repose à couverts ice Kyoto
Supporto posate ice Kyoto
Messerablage ice Kyoto



INOX
STAINLESS
STEEL
304

REF.	W _(mm)	H _(mm)	€	UE / MOQ
11013	80	8,5		0-4-40-0-0 / 4



Reposapalillos bloque satín
Chopsticks holder satin
Porte baguette satin
Supporto posate satin
Besteckhalter satin



INOX
STAINLESS
STEEL
304

REF.	W _(mm)	H _(mm)	€	UE / MOQ
● 7554	60	8		0-12-120-1920-5760 / 12
● 7555	60	8		0-12-120-1920-5760 / 12



Reposacubiertos
Cutlery holder
Repose couverts
Supporto posate
Messerablage



BEECH
WOOD

REF.	W _(mm)	H _(mm)	€	UE / MOQ
A 7843	122	8,5		1-60-240-3840-10080 / 6
B 7844	122	8,5		1-60-240-3360-10080 / 6
C 7841	122	8,5		1-60-240-3360-10080 / 6
D 7842	122	8,5		1-60-240-3360-10080 / 6



GLASS

Vidrio texturizado de manera manual. Cada pieza es única y exclusiva.

Hand-textured glass. Each piece is unique and exclusive.



Vidrio ligero y resistente. Diseño que facilitan la apilabilidad.

Lightweight and resistant glass and stackable design.

VELVET FINISH

Acabado superficial de partículas metálicas que le da un aspecto terciopelado.

Surface finish of metallic particles that gives it a velvety appearance.



	UE	MOQ	Lmm	Wmm
A 11957 REPOSACUBIERTOS MUNA VELVET ORO muna velvet cutlery rest gold, repose-couverts muna velvet or, portaposate muna velvet oro, besteckhalter muna velvet gold	0/4/0	4	100	25
B 11958 REPOSACUBIERTOS MUNA VELVET VERDE muna velvet cutlery rest green, repose-couverts muna velvet vert, portaposate muna velvet, verde besteckhalter muna velvet grün	0/4/0	4	100	25
C 11962 REPOSACUBIERTOS OVAL VELVET ORO oval velvet cutlery rest gold, repose-couverts oval velvet or, portaposate ovale velvet oro, ovaler besteckhalter velvet gold	0/4/0	4	70	30
D 11963 REPOSACUBIERTOS OVAL VELVET VERDE oval velvet cutlery rest green, repose-couverts oval velvet vert, portaposate ovale velvet verde, ovaler besteckhalter velvet grün	0/4/0	4	70	30

Conoce LUESMA & VEGA en la página: 504
More about LUESMA & VEGA in page: 504



	UE	MOQ	Lmm	Wmm
A 11959 CUCHARA MUNA VELVET ORO muna velvet spoon gold, culliere muna velvet or, cucchiaino muna velvet oro, löffel muna velvet gold	0/4/0	4	100	30
B 11960 CUCHARA MUNA VELVET VERDE muna velvet spoon green, repose-couverts muna velvet vert, portaposate muna velvet verde, besteckhalter muna velvet grün	0/4/0	4	100	30
C 11961 CUCHARA MUNA BLANCO muna velvet spoon white, repose-couverts muna velvet or, portaposate muna velvet oro, besteckhalter muna velvet gold	0/4/0	4	100	30

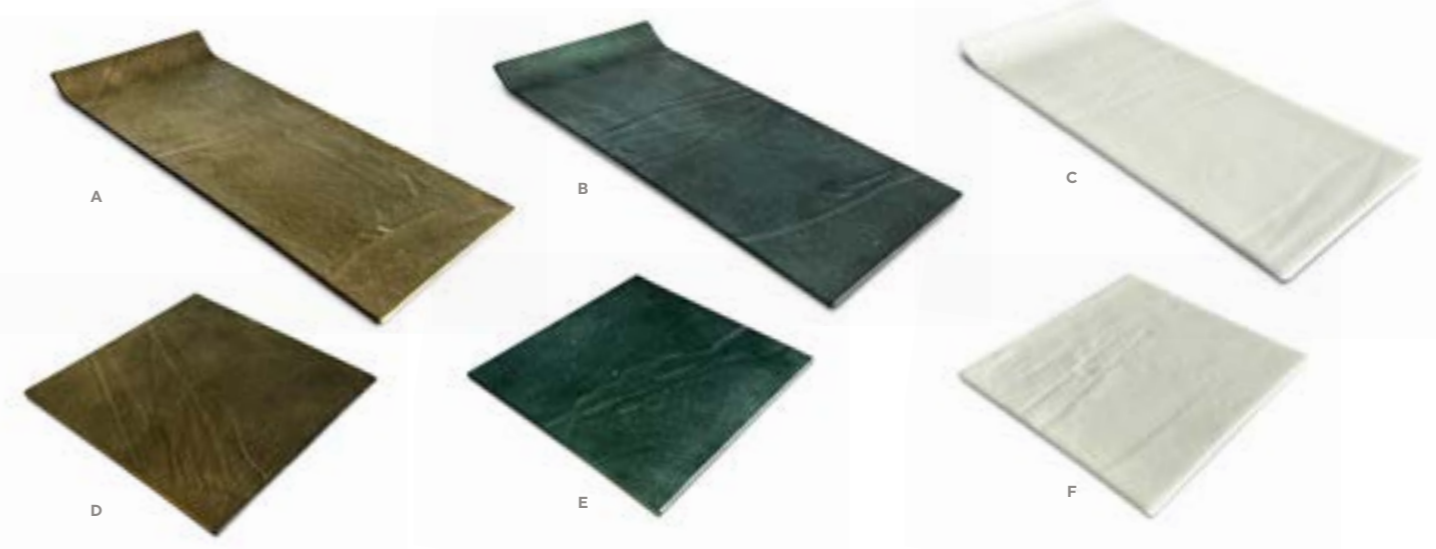

	UE	MOQ	Lmm	Wmm
A 12008 SOPORTE CUCHARA MUNA VELVET ORO muna velvet cutlery rest gold, repose-couverts muna velvet or, portaposate muna velvet oro, besteckhalter muna velvet gold	0/2/0	2	110	25
B 12009 SOPORTE CUCHARA MUNA VELVET VERDE muna velvet cutlery rest green, repose-couverts muna velvet vert, portaposate muna velvet verde, besteckhalter muna velvet grün	0/2/0	2	110	25
C 12010 SOPORTE CUCHARA MUNA BLANCO muna velvet cutlery rest white, repose-couverts muna velvet or, portaposate muna velvet bianco, besteckhalter muna velvet gold	0/2/0	2	110	25
D 12011 SOPORTE CUCHARA MUNA VELVET ORO muna velvet cutlery rest gold, repose-couverts muna velvet or, portaposate muna velvet oro, besteckhalter muna velvet gold	0/2/0	2	150	15
E 12012 SOPORTE CUCHARA MUNA VELVET VERDE muna velvet cutlery rest gold repose-couverts muna velvet or portaposate muna velvet oro besteckhalter muna velvet gold	0/2/0	2	150	15
F 12013 SOPORTE CUCHARA MUNA BLANCO muna velvet cutlery rest white repose-couverts muna velvet vert portaposate muna velvet verde besteckhalter muna velvet grün	0/2/0	2	150	15

Bcn Satin



INOX Nickel Free 18% / 3mm / Satin



Bcn Satin

INOX Nickel Free 18% / 3mm / Satin



INOX
STAINLESS
STEEL
430

		UE	MOQ	✂ mm	✂ mm
A	6721 CUCHILLO MESA table knife, couteau table, coltello tavola, tafelmesser	1/12/120/1920/5760	120	221	
B	6722 CUCHARA MESA table spoon, cuillère table, cucchiaio tavola, tafellöffel	1/12/120/1440/7200	120	200	3
C	6723 TENEDOR MESA table fork, fourchette table, forchetta tavola, tafelgabel	1/12/120/1440/7200	120	200	3
D	6724 CUCHILLO POSTRE dessert knife, couteau dessert, coltello frutta, dessertmesser	1/12/120/1920/5760	120	202	
E	6725 CUCHARA POSTRE dessert spoon, cuillère dessert, cucchiaio frutta, dessertlöffel	1/12/120/1440/7200	120	183	2,5
F	6726 TENEDOR POSTRE dessert fork, fourchette dessert, forchetta frutta, dessertgabel	1/12/120/1440/7200	120	185	2,5
G	6727 TENEDOR LUNCH cake fork, fourchette gâteau, forchetta dolce, kuchengabel	1/12/120/2520/15120	120	140	2,5
H	6728 CUCHARA CAFÉ tea spoon, cuillère café, cucchiaio caffè, kaffeelöffel	1/12/120/2520/15120	120	140	2,5
I	6729 CUCHARA MOKA moka spoon, cuillère moka, cucchiaio moka, mokkalöffel	1/12/120/2520/15120	120	110	2,5
J	8378 CUCHARA REFRESCO soda spoon, cuillère mazagran, cucchiaio bibita, longdrinklöffel	1/12/120/1440/7200	60	202	
K	8796 CUCHARA APERITIVO appetizer spoon, cuillère apéritif, cucchiaio antipasto, aperitif löffe	0/6/60/1440/4320	60	132	3
NEW	1051 BLISTER 3 CUCHILLO MESA blister 3 table knife, blister 3 couteau table, blister 3 coltello tavola, blister 3 tafelmesser	1/0/12/0/0	12		
NEW	1052 BLISTER 6 CUCHARA MESA blister 6 table spoon, blister 6 cuillère table, blister 6 cucchiaio tavola, blister 6 tafellöffel	1/0/12/0/0	12		
NEW	1053 BLISTER 6 TENEDOR MESA blister 6 table fork, blister 6 fourchette table, blister 6 forchetta tavola, blister 6 tafelgabel	1/0/12/0/0	12		
NEW	1055 BLISTER 6 TENEDOR LUNCH blister 6 cake fork, blister 6 fourchette gâteau, blister 6 forchetta dolce, blister 6 kuchengabel	1/0/12/0/0	12		
NEW	1054 BLISTER 6 CUCHARA CAFÉ blister 6 tea spoon, blister 6 cuillère café, blister 6 cucchiaio caffè, blister 6 kaffeelöffel	1/0/12/0/0	12		
NEW	1056 BLISTER 6 CUCHARA MOKA blister 6 coffee/moka spoon, blister 6 cuillère moka, blister 6 cucchiaio moka, blister 6 mokkalöffel	1/0/12/0/0	12		
	6730 24 PIEZAS 24 pieces, écrin 24 pièces, bauletto 24 pz., 24 Stück	1/0/4	4		3

Bcn Satin Gold

INOX Nickel Free 18% / 3mm / Satin



INOX STAINLESS STEEL 430

		UE	MOQ	✂ mm	✂ mm
A	6096 CUCHILLO MESA table knife, couteau table, coltello tavola, tafelmesser	1/12/120/1920/5760	60	221	
B	6097 CUCHARA MESA table spoon, cuillère table, cucchiaio tavola, tafellöffel	1/12/120/1440/7200	60	200	3
C	6098 TENEDOR MESA table fork, fourchette table, forchetta tavola, tafelgabel	1/12/120/1440/7200	60	200	3
NEW D	11906 PALA PESCADO fish knife, couteau poisson, coltello pesce, fischmesser	1/12/120/1440/7200	60	206	2,5
NEW E	11907 TENEDOR PESCADO fish fork, fourchette poisson, forchetta pesce, fischgabel	1/12/120/1440/7200	60	187	2,5
F	6350 CUCHILLO POSTRE dessert knife, couteau dessert, coltello frutta, dessertmesser	1/12/120/1920/5760	60	202	
G	6351 CUCHARA POSTRE dessert spoon, cuillère dessert, cucchiaio frutta, dessertlöffel	1/12/120/1440/7200	60	183	2,5
H	6352 TENEDOR POSTRE dessert fork, fourchette dessert, forchetta frutta, dessertgabel	1/12/120/1440/7200	60	185	2,5
I	6099 TENEDOR LUNCH cake fork, fourchette gâteau, forchetta dolce, kuchengabel	1/12/120/2520/15120	60	140	2,5
J	6100 CUCHARA CAFÉ tea spoon, cuillère café, cucchiaio caffè, kaffeelöffel	1/12/120/2520/15120	60	140	2,5
K	6101 CUCHARA MOKA coffee/moka spoon, cuillère moka, cucchiaio moka, mokkalöffel	1/12/120/2520/15120	60	110	2,5
L	7551 CUCHARA REFRESCO soda spoon, cuillère mazagran, cucchiaio bibita, longdrinklöffel	1/12/120/1440/7200	60	202	2,5
M	7902 CUCHARA ENSALADA salad spoon, cuillère à servir salade, cucchiaio servire, salatlöffel	1/10/50/800/4000	10	270	3
N	7903 TENEDOR ENSALADA salad fork, fourchette à servir salade, forchetta servire, salatgabel	1/10/50/800/4000	10	265	3
O	8797 CUCHARA APERITIVO appetizer spoon, cuillère apéritif, cucchiaio antipasto, aperitif löffel	0/6/60/1440/4320	60	132	3
6324	24 PIEZAS 24 pieces, écriin 24 pièces, bauletto 24 pz., 24 stück	1/0/4	4		3

Bcn Satin Copper

INOX Nickel Free 18% / 3mm / Satin



INOX STAINLESS STEEL 430

		UE	MOQ	✂ mm	✂ mm
A	6108 CUCHILLO MESA table knife, couteau table, coltello tavola, tafelmesser	1/12/120/1920/5760	60	221	
B	6109 CUCHARA MESA table spoon, cuillère table, cucchiaio tavola, tafellöffel	1/12/120/1440/7200	60	200	3
C	6110 TENEDOR MESA table fork, fourchette table, forchetta tavola, tafelgabel	1/12/120/1440/7200	60	200	3
NEW D	11908 PALA PESCADO fish knife, couteau poisson, coltello pesce, fischmesser	1/12/120/1440/7200	60	206	2,5
NEW E	11909 TENEDOR PESCADO fish fork, fourchette poisson, forchetta pesce, fischgabel	1/12/120/1440/7200	60	187	2,5
F	6356 CUCHILLO POSTRE dessert knife, couteau dessert, coltello frutta, dessertmesser	1/12/120/1920/5760	60	202	2,5
G	6357 CUCHARA POSTRE dessert spoon, cuillère dessert, cucchiaio frutta, dessertlöffel	1/12/120/1440/7200	60	183	2,5
H	6358 TENEDOR POSTRE dessert fork, fourchette dessert, forchetta frutta, dessertgabel	1/12/120/1440/7200	60	185	2,5
I	6111 TENEDOR LUNCH cake fork, fourchette gâteau, forchetta dolce, kuchengabel	1/12/120/2520/15120	60	140	2,5
J	6112 CUCHARA CAFÉ tea spoon, cuillère café, cucchiaio caffè, kaffeelöffel	1/12/120/2520/15120	60	140	2,5
K	6113 CUCHARA MOKA coffee/moka spoon, cuillère moka, cucchiaio moka, mokkalöffel	1/12/120/2520/15120	60	110	2,5
L	7553 CUCHARA REFRESCO soda spoon, cuillère mazagran, cucchiaio bibita, longdrinklöffel	1/12/120/1440/7200	60	202	2,5
O	8799 CUCHARA APERITIVO appetizer spoon, cuillère apéritif, cucchiaio antipasto, aperitif löffel	0/6/60/1440/4320	60	132	3
M	7965 CUCHARA ENSALADA salad spoon, cuillère à servir salade, cucchiaio servire, salatlöffel	1/10/50/800/4000	10	270	3
N	7966 TENEDOR ENSALADA salad fork, fourchette à servir salade, forchetta servire, salatgabel	1/10/50/800/4000	10	265	3
NEW	5314 BLISTER 3 CUCHILLO MESA blister 3 table knife, blister 3 couteau table, blister 3 coltello tavola, blister 3 tafelmesser	1/0/12/0/0	12		
NEW	5315 BLISTER 6 CUCHARA MESA blister 6 table spoon, blister 6 cuillère table, blister 6 cucchiaio tavola, blister 6 tafellöffel	1/0/12/0/0	12		
NEW	5316 BLISTER 6 TENEDOR MESA blister 6 table fork, blister 6 fourchette table, blister 6 forchetta tavola, blister 6 tafelgabel	1/0/12/0/0	12		
NEW	1057 BLISTER 6 TENEDOR LUNCH blister 6 cake fork, blister 6 fourchette gâteau, blister 6 forchetta dolce, blister 6 kuchengabel	1/0/12/0/0	12		
NEW	5317 BLISTER 6 CUCHARA CAFÉ blister 6 tea spoon, blister 6 cuillère café, blister 6 cucchiaio caffè, blister 6 kaffeelöffel	1/0/12/0/0	12		
NEW	1058 BLISTER 6 CUCHARA MOKA blister 6 coffee/moka spoon, blister 6 cuillère moka, blister 6 cucchiaio moka, blister 6 mokkalöffel	1/0/12/0/0	12		
6325	24 PIEZAS 24 pieces, écriin 24 pièces, bauletto 24 pz., 24 stück	1/0/4	4		3

Bcn Satin Champagne

INOX Nickel Free 18% / 3mm / Satin

Bcn Satin Black

INOX Nickel Free 18% / 3mm / Satin

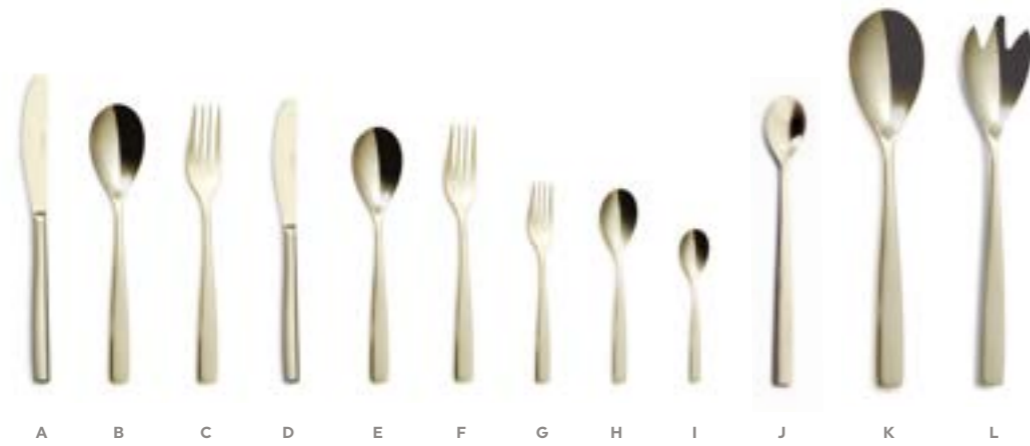

INOX STAINLESS STEEL 430

		UE	MOQ	✂ mm	✂ mm
A	6711 CUCHILLO MESA table knife, couteau table, coltello tavola, tafelmesser	1/12/120/1920/5760	60	221	
B	6712 CUCHARA MESA table spoon, cuillère table, cucchiaio tavola, tafellöffel	1/12/120/1440/7200	60	200	3
C	6713 TENEDOR MESA table fork, fourchette table, forchetta tavola, tafelgabel	1/12/120/1440/7200	60	200	3
D	6714 CUCHILLO POSTRE dessert knife, couteau dessert, coltello frutta, dessertmesser	1/12/120/1920/5760	60	202	
E	6715 CUCHARA POSTRE dessert spoon, cuillère dessert, cucchiaio frutta, dessertlöffel	1/12/120/1440/7200	60	183	2,5
F	6716 TENEDOR POSTRE dessert fork, fourchette dessert, forchetta frutta, dessertgabel	1/12/120/1440/7200	60	185	2,5
G	6717 TENEDOR LUNCH cake fork, fourchette gâteau, forchetta dolce, kuchengabel	1/12/120/2520/15120	60	140	2,5
H	6718 CUCHARA CAFE tea spoon, cuillère café, cucchiaio caffè, kaffeelöffel	1/12/120/2520/15120	60	140	2,5
I	6719 CUCHARA MOKA coffee/moka spoon, cuillère moka, cucchiaio moka, mokkalöffel	1/12/120/2520/15120	60	110	2,5
J	7899 CUCHARA REFRESCO soda spoon, cuillère mazagran, cucchiaio bibita, longdrinklöffel	1/12/120/1440/7200	60	202	2,5
K	7900 CUCHARA ENSALADA salad spoon, cuillère à servir salade, cucchiaio servire, salatlöffel	1/10/50/800/4000	10	270	3
L	7901 TENEDOR ENSALADA salad fork, fourchette à servir salade, forchetta servire, salatgabel	1/10/50/800/4000	10	265	3
NEW	5310 BLISTER 3 CUCHILLO MESA blister 3 table knife, blister 3 couteau table, blister 3 coltello tavola, blister 3 tafelmesser	1/0/12/0/0	12		
NEW	5312 BLISTER 6 CUCHARA MESA blister 6 table spoon, blister 6 cuillère table, blister 6 cucchiaio tavola, blister 6 tafellöffel	1/0/12/0/0	12		
NEW	5311 BLISTER 6 TENEDOR MESA blister 6 table fork, blister 6 fourchette table, blister 6 forchetta tavola, blister 6 tafelgabel	1/0/12/0/0	12		
NEW	1059 BLISTER 6 TENEDOR LUNCH blister 6 cake fork, blister 6 fourchette gâteau, blister 6 forchetta dolce, blister 6 kuchengabel	1/0/12/0/0	12		
NEW	5313 BLISTER 6 CUCHARA CAFE blister 6 tea spoon, blister 6 cuillère café, blister 6 cucchiaio caffè, blister 6 kaffeelöffel	1/0/12/0/0	12		
NEW	1060 BLISTER 6 CUCHARA MOKA blister 6 coffee/moka spoon, blister 6 cuillère moka, blister 6 cucchiaio moka, blister 6 mokkalöffel	1/0/12/0/0	12		
6720	24 PIEZAS 24 pieces, écrin 24 pièces, bauletto 24 pz., 24 Stück	1/0/4	4		3

INOX STAINLESS STEEL 430

		UE	MOQ	✂ mm	✂ mm
A	6102 CUCHILLO MESA table knife, couteau table, coltello tavola, tafelmesser	1/12/120/1920/5760	60	221	
B	6103 CUCHARA MESA table spoon, cuillère table, cucchiaio tavola, tafellöffel	1/12/120/1440/7200	60	200	3
C	6104 TENEDOR MESA table fork, fourchette table, forchetta tavola, tafelgabel	1/12/120/1440/7200	60	200	3
NEW	11910 PALA PESCADO table fork, fourchette table, forchetta tavola, tafelgabel	1/12/120/1440/7200	60	206	2,5
NEW	11911 TENEDOR PESCADO fish knife, couteau poisson, coltello pesce, fischmesser	1/12/120/1440/7200	60	187	2,5
F	6353 CUCHILLO POSTRE dessert knife, couteau dessert, coltello frutta, dessertmesser	1/12/120/1920/5760	60	202	2,5
G	6354 CUCHARA POSTRE dessert spoon, cuillère dessert, cucchiaio frutta, dessertlöffel	1/12/120/1440/7200	60	183	2,5
H	6355 TENEDOR POSTRE dessert fork, fourchette dessert, forchetta frutta, dessertgabel	1/12/120/1440/7200	60	185	2,5
I	6105 TENEDOR LUNCH cake fork, fourchette gâteau, forchetta dolce, kuchengabel	1/12/120/2520/15120	60	140	2,5
J	6106 CUCHARA CAFÉ tea spoon, cuillère café, cucchiaio caffè, kaffeelöffel	1/12/120/2520/15120	60	140	2,5
K	6107 CUCHARA MOKA coffee/moka spoon, cuillère moka, cucchiaio moka, mokkalöffel	1/12/120/2520/15120	60	110	2,5
L	7552 CUCHARA REFRESCO soda spoon, cuillère mazagran, cucchiaio bibita, longdrinklöffel	1/12/120/1440/7200	60	202	3
O	8798 CUCHARA APERITIVO appetizer spoon, cuillère apéritif, cucchiaio antipasto, aperitif löffel	0/6/60/1440/4320	10	132	3
M	7963 CUCHARA ENSALADA salad spoon, cuillère à servir salade, cucchiaio servire, salatlöffel	1/10/50/800/4000	10	270	3
N	7964 TENEDOR ENSALADA salad fork, fourchette à servir salade, forchetta servire, salatgabel	1/10/50/800/4000	10	265	3
NEW	5318 BLISTER 3 CUCHILLO MESA blister 3 table knife, blister 3 couteau table, blister 3 coltello tavola, blister 3 tafelmesser	1/0/12/0/0	12		
NEW	5320 BLISTER 6 CUCHARA MESA blister 6 table spoon, blister 6 cuillère table, blister 6 cucchiaio tavola, blister 6 tafellöffel	1/0/12/0/0	12		
NEW	5319 BLISTER 6 TENEDOR MESA blister 6 table fork, blister 6 fourchette table, blister 6 forchetta tavola, blister 6 tafelgabel	1/0/12/0/0	12		
NEW	1061 BLISTER 6 TENEDOR LUNCH blister 6 cake fork, blister 6 fourchette gâteau, blister 6 forchetta dolce, blister 6 kuchengabel	1/0/12/0/0	12		
NEW	5321 BLISTER 6 CUCHARA CAFE blister 6 tea spoon, blister 6 cuillère café, blister 6 cucchiaio caffè, blister 6 kaffeelöffel	1/0/12/0/0	12		
NEW	1062 BLISTER 6 CUCHARA MOKA blister 6 coffee/moka spoon, blister 6 cuillère moka, blister 6 cucchiaio moka, blister 6 mokkalöffel	1/0/12/0/0	12		
6323	24 PIEZAS 24 pieces, écrin 24 pièces, bauletto 24 pz., 24 Stück	1/0/4	4		3

Malvarrosa

INOX Nickel Free 18% / 4mm / Mirror

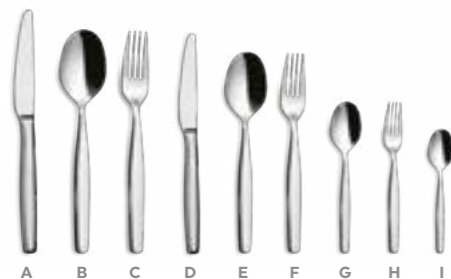

INOX
STAINLESS
STEEL
430

A	6573 CUCHILLO MESA table knife, couteau table, coltello tavola, tafelmesser	0/12/120/1920/5760	120	225	
B	6574 CUCHARA MESA table spoon, cuillère table, cucchiaio tavola, tafellöffel	0/12/120/1440/7200	120	206	4
C	6575 TENEDOR MESA table fork, fourchette table, forchetta tavola, tafelgabel	0/12/120/1440/7200	120	206	4
D	6576 CUCHILLO POSTRE dessert knife, couteau dessert, coltello frutta, dessertmesser	0/12/120/1440/7200	120	203	
E	6577 CUCHARA POSTRE dessert spoon, cuillère dessert, cucchiaio frutta, dessertlöffel	0/12/120/1440/7200	120	185	3,5
F	6578 TENEDOR POSTRE dessert fork, fourchette dessert, forchetta frutta, dessertgabel	0/12/120/1440/7200	120	185	3,5
G	6579 CUCHARA CAFÉ tea spoon, cuillère café, cucchiaio caffè, kaffeelöffel	0/12/120/2520/15120	120	140	3
H	6580 TENEDOR LUNCH cake fork, fourchette gâteau, forchetta dolce, kuchengabel	0/12/120/2520/15120	120	140	3
I	6581 CUCHARA MOKA coffee/moka spoon, cuillère moka, cucchiaio moka, mokkalöffel	0/12/120/2520/15120	120	115	3
	6582 MAZO 2 CUCHILLO MESA film 2 table knife, film 2 couteau table, film 2 coltello tavola, film 2 tafelmesser	1/0/48/1008/3024	48	225	
	6583 MAZO 3 CUCHARA MESA film 3 table spoon, film 3 cuillère table, film 3 cucchiaio tavola, film 3 tafellöffel	1/0/48/1200/3600	48	206	4
	6584 MAZO 3 TENEDOR MESA film 3 table fork, film 3 fourchette table, film 3 forchetta tavola, film 3 tafelgabel	1/0/48/1200/3600	48	206	4
	6585 MAZO 6 TENEDOR LUNCH film 6 cake fork, film 6 fourchette gâteau, film 6 forchetta dolce, film 6 kuchengabel	1/0/48/1152/4608	48	140	3
	6586 MAZO 6 CUCHARA CAFÉ film 6 tea spoon, film 6 cuillère café, film 6 cucchiaio caffè, film 6 kaffeelöffel	1/0/48/1152/4608	48	140	3
	6587 MAZO 6 CUCHARA MOKA film 6 coffee/moka spoon, film 6 cuillère moka, film 6 cucchiaio moka, film 6 mokkalöffel	1/0/48/1152/4608	48	115	3
	6588 24 PIEZAS 24 pieces, écrin 24 pièces, bauletto 24 pz., 24 stück	1/0/4	4		4

120

Oslo Eco

INOX Nickel Free 18% / 7mm / Mirror / FORGED



INOX
STAINLESS
STEEL
430

NEW

A	5474 CUCHILLO MESA table knife, couteau table, coltello tavola, tafelmesser	0/12/120/1920/5760	120	235	
B	1336 CUCHARA MESA table spoon, cuillère table, cucchiaio tavola, tafellöffel	0/12/120/1440/7200	120	208	7
C	1337 TENEDOR MESA table fork, fourchette table, forchetta tavola, tafelgabel	0/12/120/1440/7200	120	208	7
D	2568 TENEDOR LUNCH cake fork, fourchette gâteau, forchetta dolce, kuchengabel	0/12/120/2520/15120	120	150	5,5
E	1338 CUCHARA CAFÉ tea spoon, cuillère café, cucchiaio caffè, kaffeelöffel	0/12/120/2520/15120	120	145	5,5
F	2569 CUCHARA MOKA coffee/moka spoon, cuillère moka, cucchiaio moka, mokkalöffel	0/12/120/2520/15120	120	120	4,5
	0298 24 PIEZAS 24 pieces, écrin 24 pièces, bauletto 24 pz., 24 stück	1/0/4	4		7

UE	MOQ	▶ mm	✂ mm
0/12/120/1920/5760	120	235	
0/12/120/1440/7200	120	208	7
0/12/120/1440/7200	120	208	7
0/12/120/2520/15120	120	150	5,5
0/12/120/2520/15120	120	145	5,5
0/12/120/2520/15120	120	120	4,5
1/0/4	4		7

121

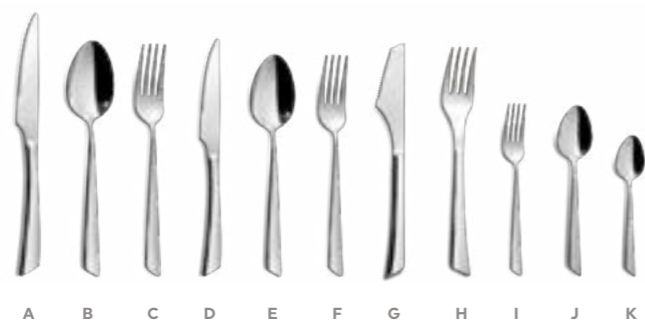

INOX
STAINLESS
STEEL
430

A	3197 CUCHILLO CHULETERO steak knife, couteau steak, coltello bistecca, steakmesser
B	3198 CUCHARA MESA table spoon, cuillère table, cucchiaio tavola, tafellöffel
C	3199 TENEDOR MESA table fork, fourchette table, forchetta tavola, tafelgabel
D	3200 CUCHILLO POSTRE dessert knife, couteau dessert, coltello frutta, dessertmesser
E	3201 CUCHARA POSTRE dessert spoon, cuillère dessert, cucchiaio frutta, dessertlöffel
F	3202 TENEDOR POSTRE dessert fork, fourchette dessert, forchetta frutta, dessertgabel
G	3263 CUCHILLO PIZZA pizza knife, couteau pizza, coltello pizza, pizza tafelmesser
H	3264 TENEDOR PIZZA pizza fork, fourchette pizza, forchetta pizza, pizza gabel
I	3203 TENEDOR LUNCH cake fork, fourchette gâteau, forchetta dolce, kuchengabel
J	3204 CUCHARA CAFÉ tea spoon, cuillère café, cucchiaio caffè, kaffeelöffel
K	3205 CUCHARA MOKA coffee/moka spoon, cuillère moka, cucchiaio moka, mokkalöffel
	3216 MAZO 2 CUCHILLO CHULETERO film 2 steak knife, film 2 couteau steak, film 2 coltello bistecca, film 2 steakmesser
	3217 MAZO 3 CUCHARA MESA film 3 table spoon, film 3 cuillère table, film 3 cucchiaio tavola, film 3 tafellöffel
	3218 MAZO 3 TENEDOR MESA film 3 table fork, film 3 fourchette table, film 3 forchetta tavola, film 3 tafelgabel
	3219 MAZO 2 CUCHILLO POSTRE film 2 dessert knife, film 2 couteau dessert, film 2 coltello frutta, film 2 dessertmesser
	3220 MAZO 3 CUCHARA POSTRE film 3 dessert spoon, film 3 cuillère dessert, film 3 cucchiaio frutta, film 3 dessertlöffel
	3221 MAZO 3 TENEDOR POSTRE film 3 dessert fork, film 3 fourchette dessert, film 3 forchetta frutta, film 3 dessertgabel
	3222 MAZO 6 TENEDOR LUNCH film 6 cake fork, film 6 fourchette gâteau, film 6 forchetta dolce, film 6 kuchengabel
	3223 MAZO 6 CUCHARA CAFÉ film 6 tea spoon, film 6 cuillère café, film 6 cucchiaio caffè, film 6 kaffeelöffel
	3224 MAZO 6 CUCHARA MOKA film 6 coffee/moka spoon, film 6 cuillère moka, film 6 cucchiaio moka, film 6 mokkalöffel

UE	MOQ	▶ mm	✂ mm
0/12/120/1920/5760	120	233	
0/12/120/1440/7200	120	208	4
0/12/120/1440/7200	120	208	4
0/12/120/1920/5760	120	210	
0/12/120/1440/7200	120	195	4
0/12/120/1440/7200	120	195	4
0/12/120/1920/5760	120	205	
0/12/120/1920/5760	120	202	4
0/12/120/2520/15120	120	152	3
0/12/120/2520/15120	120	150	3
0/12/120/2520/15120	120	125	3
1/0/48/1008/3024	48	233	
1/0/48/1200/3600	48	208	4
1/0/48/1200/3600	48	208	4
1/0/48/1008/3024	48	210	
1/0/48/1200/3600	48	195	4
1/0/48/1200/3600	48	195	4
1/0/48/1152/4608	48	152	3
1/0/48/1152/4608	48	150	3
1/0/48/1152/4608	48	125	3



3227 24 PIEZAS
24 pieces. écrin 24 pièces. bauletto 24 pz., 24 stück

UE	MOQ	▶ mm	✂ mm
1/0/4	4		4





INOX Nickel Free 18% / 4mm / Mirror



INOX
STAINLESS
STEEL
430

A	6537	CUCHILLO MESA XL XL table knife, couteau table XL, coltello tavola XL, XL tafelmesser
B	6538	CUCHARA MESA XL XL table spoon, cuillère table XL, cucchiaio tavola XL, XL tafellöffel
C	6539	TENEDOR MESA XL XL table fork, fourchette table XL, forchetta tavola XL, XL tafelgabel
D	6546	CUCHARA CAFÉ XL XL coffee spoon, cuillère café XL, cucchiaio caffè XL, XL kaffeeelöffel
E	6540	CUCHILLO MESA table knife, couteau table, coltello tavola, tafelmesser
F	6541	CUCHARA MESA table spoon, cuillère table, cucchiaio tavola, tafellöffel
G	6542	TENEDOR MESA table fork, fourchette table, forchetta tavola, tafelgabel
H	6543	CUCHILLO POSTRE dessert knife, couteau dessert, coltello frutta, dessertmesser
I	6544	CUCHARA POSTRE dessert spoon, cuillère dessert, cucchiaio frutta, dessertlöffel
J	6545	TENEDOR POSTRE dessert fork, fourchette dessert, forchetta frutta, dessertgabel
K	6547	CUCHARA CAFÉ tea spoon, cuillère café, cucchiaio caffè, kaffeeelöffel
L	6548	TENEDOR LUNCH cake fork, fourchette gâteau, forchetta dolce, kuchengabel
M	6549	CUCHARA MOKA coffee/moka spoon, cuillère moka, cucchiaio moka, mokkalöffel
	6550	MAZO 2 CUCHILLO MESA film 2 table knife, film 2 couteau table, film 2 coltello tavola, film 2 tafelmesser
	6551	MAZO 3 CUCHARA MESA film 3 table spoon, film 3 cuillère table, film 3 cucchiaio tavola, film 3 tafellöffel
	6552	MAZO 3 TENEDOR MESA film 3 table fork, film 3 fourchette table, film 3 forchetta tavola, film 3 tafelgabel
	6553	MAZO 6 TENEDOR LUNCH film 6 cake fork, film 6 fourchette gâteau, film 6 forchetta dolce, film 6 kuchengabel
	6554	MAZO 6 CUCHARA CAFÉ film 6 tea spoon, film 6 cuillère café, film 6 cucchiaio caffè, film 6 kaffeeelöffel
	6555	MAZO 6 CUCHARA MOKA film 6 coffee/moka spoon, film 6 cuillère moka, film 6 cucchiaio moka, film 6 mokkalöffel
	6556	24 PIEZAS 24 pieces, écrien 24 pièces, bauletto 24 pz., 24 stück

UE	MOQ	✂ mm	✂ mm
0/12/120/1920/5760	120	250	
0/12/120/1440/7200	120	230	4
0/12/120/1440/7200	120	228	4
0/12/120/2520/15120	120	162	3
0/12/120/1920/5760	120	233	
0/12/120/1440/7200	120	206	4
0/12/120/1440/7200	120	204	4
0/12/120/1920/5760	120	209	
0/12/120/1440/7200	120	185	3
0/12/120/1440/7200	120	184	3
0/12/120/2520/15120	120	145	3
0/12/120/2520/15120	120	150	3
0/12/120/2520/15120	120	115	2
1/0/48/1008/3024	48	233	
1/0/48/1200/3600	48	206	4
1/0/48/1200/3600	48	204	4
1/0/48/1152/4608	48	150	3
1/0/48/1152/4608	48	145	3
1/0/48/1152/4608	48	115	2
1/0/4	4		3



Canada Vintage

INOX Nickel Free 18% / 4mm / Vintage



Canada Vintage Gold

INOX Nickel Free 18% / 4mm / Vintage



INOX
STAINLESS
STEEL
430

- A **1241** CUCHILLO MESA
table knife, couteau table, coltello tavola, tafelmesser
- B **1242** CUCHARA MESA
table spoon, cuillère table, cucchiaio tavola, tafellöffel
- C **1243** TENEDOR MESA
table fork, fourchette table, forchetta tavola, tafelgabel
- D **1244** CUCHILLO POSTRE
dessert knife, couteau dessert, coltello frutta, dessertmesser
- E **1245** CUCHARA POSTRE
dessert spoon, cuillère dessert, cucchiaio frutta, dessertlöffel
- F **1246** TENEDOR POSTRE
dessert fork, fourchette dessert, forchetta frutta, dessertgabel
- G **1247** TENEDOR LUNCH
cake fork, fourchette gâteau, forchetta dolce, kuchengabel
- H **1248** CUCHARA CAFÉ
tea spoon, cuillère café, cucchiaio caffè, kaffeelöffel
- I **1249** CUCHARA MOKA
coffee/moka spoon, cuillère moka, cucchiaio moka, mokkalöffel

1228 24 PIEZAS
24 pieces, écrin 24 pièces, bauletto 24 pz., 24 stück

UE	MOQ	▶ mm	✂ mm
0/12/120/1920/5760	60	233	
0/12/120/1440/7200	60	206	4
0/12/120/1440/7200	60	204	4
0/12/120/1920/5760	60	209	
0/12/120/1440/7200	60	185	3
0/12/120/1440/7200	60	184	3
0/12/120/2520/15120	60	145	3
0/12/120/2520/15120	60	150	3
0/12/120/2520/15120	60	115	2
1/0/4	4		4

INOX
STAINLESS
STEEL
430

- A **1252** CUCHILLO MESA
table knife, couteau table, coltello tavola, tafelmesser
- B **1253** CUCHARA MESA
table spoon, cuillère table, cucchiaio tavola, tafellöffel
- C **1254** TENEDOR MESA
table fork, fourchette table, forchetta tavola, tafelgabel
- D **1255** CUCHILLO POSTRE
dessert knife, couteau dessert, coltello frutta, dessertmesser
- E **1256** CUCHARA POSTRE
dessert spoon, cuillère dessert, cucchiaio frutta, dessertlöffel
- F **1257** TENEDOR POSTRE
dessert fork, fourchette dessert, forchetta frutta, dessertgabel
- G **1258** TENEDOR LUNCH
cake fork, fourchette gâteau, forchetta dolce, kuchengabel
- H **1259** CUCHARA CAFÉ
tea spoon, cuillère café, cucchiaio caffè, kaffeelöffel
- I **1260** CUCHARA MOKA
coffee/moka spoon, cuillère moka, cucchiaio moka, mokkalöffel

1229 24 PIEZAS
24 pieces, écrin 24 pièces, bauletto 24 pz., 24 stück

UE	MOQ	▶ mm	✂ mm
0/12/120/1920/5760	60	233	
0/12/120/1440/7200	60	206	4
0/12/120/1440/7200	60	204	4
0/12/120/1920/5760	60	209	
0/12/120/1440/7200	60	185	3
0/12/120/1440/7200	60	184	3
0/12/120/2520/15120	60	145	3
0/12/120/2520/15120	60	150	3
0/12/120/2520/15120	60	115	2
1/0/4	4		4

Canada Vintage Champagne

INOX Nickel Free 18% / 4mm / Vintage

NEW



Canada Polvo de Luna

INOX Nickel Free 18% / 4mm / Shotblasting



INOX
STAINLESS
STEEL
430

- A **11645** CUCHILLO MESA
table knife, couteau table, coltello tavola, tafelmesser
- B **11646** CUCHARA MESA
table spoon, cuillère table, cucchiaio tavola, tafellöffel
- C **11647** TENEDOR MESA
table fork, fourchette table, forchetta tavola, tafelgabel
- D **11648** CUCHILLO POSTRE
dessert knife, couteau dessert, coltello frutta, dessertmesser
- E **11649** CUCHARA POSTRE
dessert spoon, cuillère dessert, cucchiaio frutta, dessertlöffel
- F **11650** TENEDOR POSTRE
dessert fork, fourchette dessert, forchetta frutta, dessertgabel
- G **11651** TENEDOR LUNCH
cake fork, fourchette gâteau, forchetta dolce, kuchengabel
- H **11652** CUCHARA CAFÉ
tea spoon, cuillère café, cucchiaio caffè, kaffeelöffel
- I **11653** CUCHARA MOKA
coffee/moka spoon, cuillère moka, cucchiaio moka, mokkalöffel

UE	MOQ	mm	mm
0/12/120/1920/5760	60	233	
0/12/120/1440/7200	60	206	4
0/12/120/1440/7200	60	204	4
0/12/120/1920/5760	60	209	
0/12/120/1440/7200	60	185	3
0/12/120/1440/7200	60	184	3
0/12/120/2520/15120	60	145	3
0/12/120/2520/15120	60	150	3
0/12/120/2520/15120	60	115	2

11654 24 PIEZAS
24 pieces, écrin 24 pièces, bauletto 24 pz., 24 stück

INOX
STAINLESS
STEEL
430

- A **5073** CUCHILLO MESA
table knife, couteau table, coltello tavola, tafelmesser
- B **5074** CUCHARA MESA
table spoon, cuillère table, cucchiaio tavola, tafellöffel
- C **5075** TENEDOR MESA
table fork, fourchette table, forchetta tavola, tafelgabel
- D **5076** CUCHILLO POSTRE
dessert knife, couteau dessert, coltello frutta, dessertmesser
- E **5077** CUCHARA POSTRE
dessert spoon, cuillère dessert, cucchiaio frutta, dessertlöffel
- F **5078** TENEDOR POSTRE
dessert fork, fourchette dessert, forchetta frutta, dessertgabel
- G **5079** TENEDOR LUNCH
cake fork, fourchette gâteau, forchetta dolce, kuchengabel
- H **5080** CUCHARA CAFÉ
tea spoon, cuillère café, cucchiaio caffè, kaffeelöffel
- I **5081** CUCHARA MOKA
coffee/moka spoon, cuillère moka, cucchiaio moka, mokkalöffel

UE	MOQ	mm	mm
0/12/120/1920/5760	120	233	
0/12/120/1440/7200	120	206	4
0/12/120/1440/7200	120	204	4
0/12/120/1920/5760	120	209	
0/12/120/1440/7200	120	185	3
0/12/120/1440/7200	120	184	3
0/12/120/2520/15120	120	145	3
0/12/120/2520/15120	120	150	3
0/12/120/2520/15120	120	115	2

5083 24 PIEZAS
24 pieces, écrin 24 pièces, bauletto 24 pz., 24 stück

Canada Vintage Copper

INOX Nickel Free 18% / 4mm / Vintage



Canada Vintage Black

INOX Nickel Free 18% / 4mm / Vintage



INOX
STAINLESS
STEEL
430

A	1270	CUCHILLO MESA table knife, couteau table, coltello tavola, tafelmesser
B	1271	CUCHARA MESA table spoon, cuillère table, cucchiaio tavola, tafellöffel
C	1272	TENEDOR MESA table fork, fourchette table, forchetta tavola, tafelgabel
D	1273	CUCHILLO POSTRE dessert knife, couteau dessert, coltello frutta, dessertmesser
E	1274	CUCHARA POSTRE dessert spoon, cuillère dessert, cucchiaio frutta, dessertlöffel
F	1275	TENEDOR POSTRE dessert fork, fourchette dessert, forchetta frutta, dessertgabel
G	1276	TENEDOR LUNCH cake fork, fourchette gâteau, forchetta dolce, kuchengabel
H	1277	CUCHARA CAFÉ tea spoon, cuillère café, cucchiaio caffè, kaffeelöffel
I	1278	CUCHARA MOKA coffee/moka spoon, cuillère moka, cucchiaio moka, mokkalöffel

1231 24 PIEZAS
24 pieces, écrien 24 pièces, bauletto 24 pz., 24 stück

130

INOX
STAINLESS
STEEL
430

A	1261	CUCHILLO MESA table knife, couteau table, coltello tavola, tafelmesser
B	1262	CUCHARA MESA table spoon, cuillère table, cucchiaio tavola, tafellöffel
C	1263	TENEDOR MESA table fork, fourchette table, forchetta tavola, tafelgabel
D	1264	CUCHILLO POSTRE dessert knife, couteau dessert, coltello frutta, dessertmesser
E	1265	CUCHARA POSTRE dessert spoon, cuillère dessert, cucchiaio frutta, dessertlöffel
F	1266	TENEDOR POSTRE dessert fork, fourchette dessert, forchetta frutta, dessertgabel
G	1267	TENEDOR LUNCH cake fork, fourchette gâteau, forchetta dolce, kuchengabel
H	1268	CUCHARA CAFÉ tea spoon, cuillère café, cucchiaio caffè, kaffeelöffel
I	1269	CUCHARA MOKA coffee/moka spoon, cuillère moka, cucchiaio moka, mokkalöffel

1230 24 PIEZAS
24 pieces, écrien 24 pièces, bauletto 24 pz., 24 stück

131

UE	MOQ	▶ mm	✂ mm
0/12/120/1920/5760	60	233	
0/12/120/1440/7200	60	206	4
0/12/120/1440/7200	60	204	4
0/12/120/1920/5760	60	209	
0/12/120/1440/7200	60	185	3
0/12/120/1440/7200	60	184	3
0/12/120/2520/15120	60	145	3
0/12/120/2520/15120	60	150	3
0/12/120/2520/15120	60	115	2



UE	MOQ	▶ mm	✂ mm
0/12/120/1920/5760	60	233	
0/12/120/1440/7200	60	206	4
0/12/120/1440/7200	60	204	4
0/12/120/1920/5760	60	209	
0/12/120/1440/7200	60	185	3
0/12/120/1440/7200	60	184	3
0/12/120/2520/15120	60	145	3
0/12/120/2520/15120	60	150	3
0/12/120/2520/15120	60	115	2



Finger Food



INOX Nickel Free 18% / 2mm / Mirror



A

B

C

D

132

Finger Food

INOX Nickel Free 18% / 2mm / Vintage



MINI CUBIERTOS PARA EXPERIENCIAS DE GRAN SABOR
MINI CUTLERY FOR GREAT TASTING EXPERIENCES



Conbertería de diseño propio creada para comidas de servicio rápido.
Cutlery of our own design created for quick service meals.

INOX
STAINLESS
STEEL
430

- A **8784** CUCHILLO LUNCH
cake knife, couteau gâteau, coltello dolce, kuchenmesser
- B **8786** CUCHARA CAFÉ
tea spoon, cuillère café, cucchiaio caffè, kaffeeelöffel
- C **8785** TENEDOR LUNCH
cake fork, fourchette gâteau, forchetta dolce, kuchengabel
- D **8787** PINCHO TAPAS
cocktail stick, stick à cocktail, spiedo, spieb
- 8795** PACK 4 PCS
pack 4 pieces, pack 4 pièces, pack 4 pz., 4 pack

UE	MOQ	▶ mm	✂ mm
0/12/120/2520/15120	24	140	6
0/12/120/2520/15120	24	130	2
0/12/120/2520/15120	24	130	2
0/12/120/2520/15120	24	137	2
1/24/96/576/2880	24		2



INOX
STAINLESS
STEEL
430



1001 Black

INOX Nickel Free 18% / 1,5mm / PVD

- A **1746** TENEDOR MINI LUNCH
mini cake fork, fourchette minigâteau, forchetta mini dolce, kuchengabel klein
- B **1747** CUCHARA MOKA
coffee/moka spoon, cuillère moka, cucchiaio moka, mokkalöffel

UE	MOQ	▶ mm	✂ mm
0/12/600/25200/75600	120	110	1
0/12/600/25200/75600	120	110	1



133

Santorini



INOX Nickel Free 18% / 3,5mm / Mirror



Santorini

INOX Nickel Free 18% / 3,5mm / Mirror

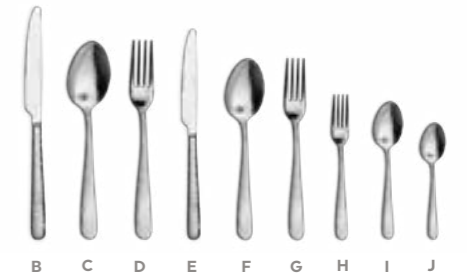

INOX
STAINLESS
STEEL
430

- A **11584** CUCHILLO CHULETERO
steak knife, couteau steak, coltello bistecca, steakmesser
- B **10642** CUCHILLO MESA
table knife, couteau table, coltello tavola, tafelmesser
- C **10643** CUCHARA MESA
table spoon, cuillère table, cucchiaio tavola, tafellöffel
- D **10644** TENEDOR MESA
table fork, fourchette table, forchetta tavola, tafelgabel
- E **10832** CUCHILLO POSTRE
dessert knife, couteau dessert, coltello frutta, dessertmesser
- F **10833** CUCHARA POSTRE
dessert spoon, cuillère dessert, cucchiaio frutta, dessertlöffel
- G **10834** TENEDOR POSTRE
dessert fork, fourchette dessert, forchetta frutta, dessertgabel
- H **10645** TENEDOR LUNCH
cake fork, fourchette gâteau, forchetta dolce, kuchengabel
- I **10646** CUCHARA CAFÉ
tea spoon, cuillère café, cucchiaio caffè, kaffeelöffel
- J **10647** CUCHARA MOKA
coffee/moka spoon, cuillère moka, cucchiaio moka, mokkalöffe
- B **10928** MAZO 2 CUCHILLO MESA
film 2 table knife, film 2 couteau table, film 2 coltello tavola, film 2 tafelmesser
- C **10929** MAZO 3 CUCHARA MESA
film 3 table spoon, film 3 cuillère table, film 3 cucchiaio tavola, film 3 löffel
- G **10930** MAZO 3 TENEDOR MESA
film 3 table fork, film 3 fourchette table, film 3 forchetta tavola, film 3 tafelgabel
- H **10931** MAZO 6 TENEDOR LUNCH
film 6 cake fork, film 6 fourchette gâteau, film 6 forchetta dolce, film 6 kuchengabel
- I **10932** MAZO 6 CUCHARA CAFÉ
film 6 tea spoon, film 6 cuillère café, film 6 cucchiaio caffè, film 6 kaffeelöffel
- J **10933** MAZO 6 CUCHARA MOKA
film 6 coffee/moka spoon, film 6 cuillère moka, film 6 cucchiaio moka, film 6 mokkalöffe

- 5187** 24 PIEZAS
24 pieces, écriin 24 pièces, bauletto 24 pz., 24 stück

UE	MOQ	▶ mm	✕ mm
1/12/120/1920/5760	120	232	
0//120/1920/5760	120	235	
0//120/1440/7200	120	200	3,5
0//120/1440/7200	120	200	3,5
0/12/120/1920/5760	120	210	
0/12/120/1440/7200	120	180	
0/12/120/1440/7200	120	180	
0//120/2520/15120	120	148	2
0//120/2520/15120	120	140	2
0//120/2520/15120	120	116	2
1/0/48/1008/3024	48	235	
1/0/48/1200/3600	48	200	
1/0/48/1200/3600	48	200	
1/0/48/1152/4608	48	148	
1/0/48/1152/4608	48	148	
1/0/48/1152/4608	48	116	
1/0/4	4		



Chef Free

INOX Nickel Free 18% / 3,5mm / Mirror

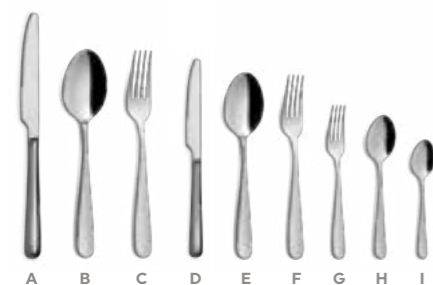

Lotus Free

INOX Nickel Free 18% / 3,5mm / Mirror

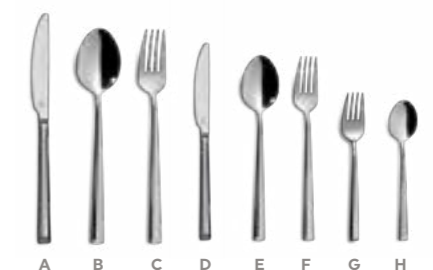

INOX
STAINLESS
STEEL
430

A	5033	CUCHILLO MESA table knife, couteau table, coltello tavola, tafelmesser
B	9626	CUCHARA MESA table spoon, cuillère table, cucchiaio tavola, tafellöffel
C	9627	TENEDOR MESA table fork, fourchette table, forchetta tavola, tafelgabel
D	5034	CUCHILLO POSTRE dessert knife, couteau dessert, coltello frutta, dessertmesser
E	10835	CUCHARA POSTRE dessert spoon, cuillère dessert, cucchiaio frutta, dessertlöffel
F	10836	TENEDOR POSTRE dessert fork, fourchette dessert, forchetta frutta, dessertgabel
G	10837	TENEDOR LUNCH cake fork, fourchette gâteau, forchetta dolce, kuchengabel
H	9628	CUCHARA CAFÉ tea spoon, cuillère café, cucchiaio caffè, kaffeelöffel
I	10838	CUCHARA MOKA coffee/moka spoon, cuillère moka, cucchiaio moka, mokkalöffel

INOX
STAINLESS
STEEL
430

A	3139	CUCHILLO MESA table knife, couteau table, coltello tavola, tafelmesser
B	9629	CUCHARA MESA table spoon, cuillère table, cucchiaio tavola, tafellöffel
C	9630	TENEDOR MESA table fork, fourchette table, forchetta tavola, tafelgabel
D	3145	CUCHILLO POSTRE dessert knife, couteau dessert, coltello frutta, dessertmesser
E	5255	CUCHARA POSTRE dessert spoon, cuillère dessert, cucchiaio frutta, dessertlöffel
F	5256	TENEDOR POSTRE dessert fork, fourchette dessert, forchetta frutta, dessertgabel
G	5257	TENEDOR LUNCH cake fork, fourchette gâteau, forchetta dolce, kuchengabel
H	9631	CUCHARA CAFÉ tea spoon, cuillère café, cucchiaio caffè, kaffeelöffel
I	5258	CUCHARA MOKA coffee/moka spoon, cuillère moka, cucchiaio moka, mokkalöffel

UE	MOQ	▶ mm	✂ mm
0/12/120/1920/5760	60	225	
0/12/120/1440/7200	120	211	3,5
0/12/120/1440/7200	120	211	3,5
0/12/120/1920/5760	60	195	
0/12/120/1440/7200	120	188	3,5
0/12/120/1440/7200	120	186	3,5
0/12/120/2520/15120	120	147	3,5
0/12/120/2520/15120	120	139	3,5
0/12/120/2520/15120	120	114	

Kyoto

INOX 18/10 / 5,5mm / Mirror / Satin

Cheese

INOX Nickel Free 18% / 3mm / Mirror

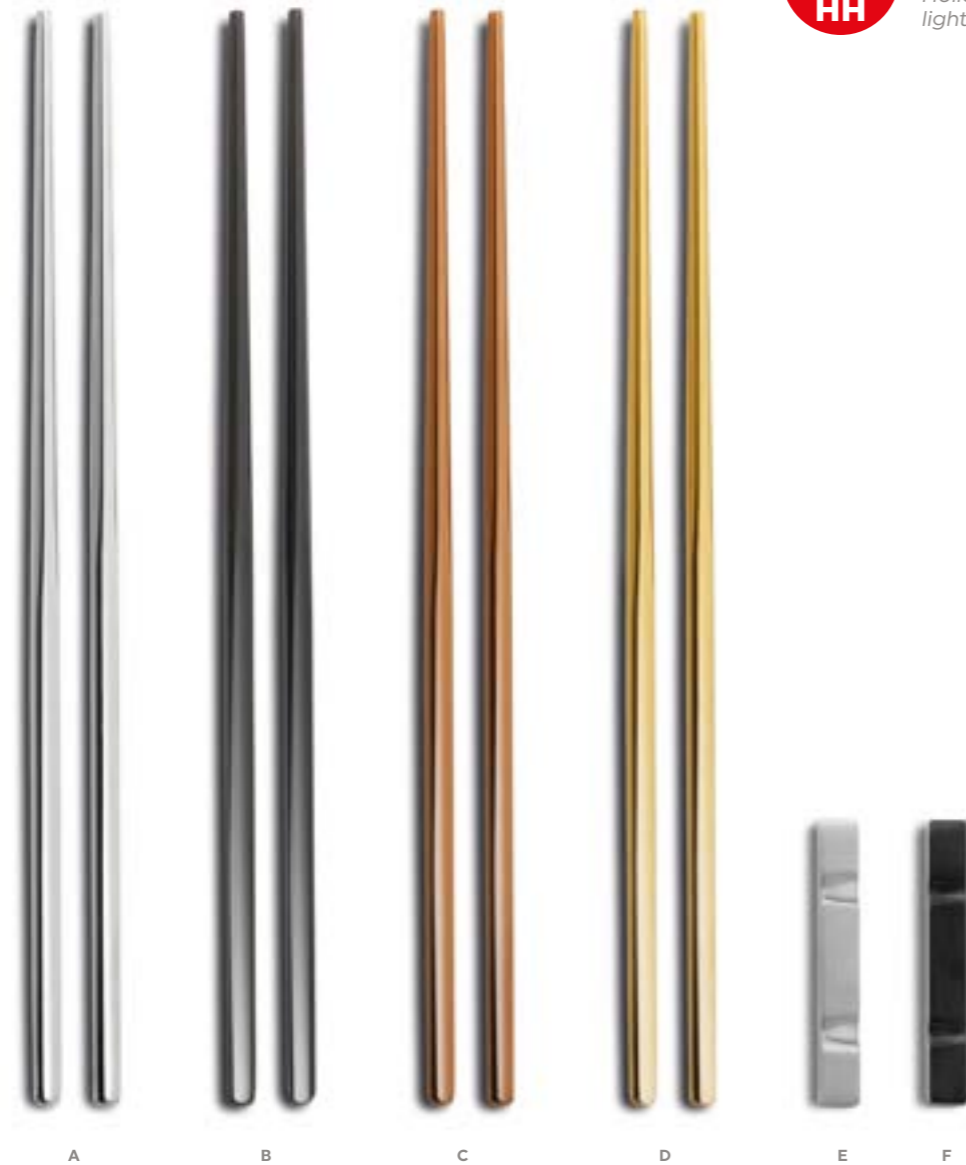

Mango hueco para una manipulación más ligera.
Hollow handle for lighter handling.

INOX STAINLESS STEEL 430

- A **5610** CUCHILLO CHULETERO
steak knife, couteau steak, coltello bistecca, steakmesser
- B **5611** CUCHARA MESA
table spoon, cuillère table, cucchiaio tavola, tafellöffel
- C **5612** TENEDOR MESA
table fork, fourchette table, forchetta tavola, tafelgabel
- D **5615** CUCHILLO POSTRE
dessert knife, couteau dessert, coltello frutta, dessertmesser
- E **5613** CUCHARA POSTRE
dessert spoon, cuillère dessert, cucchiaio frutta, dessertlöffel
- F **5614** TENEDOR POSTRE
dessert fork, fourchette dessert, forchetta frutta, dessertgabel
- G **5593** CUCHARA CAFÉ
tea spoon, cuillère café, cucchiaio caffè, kaffeelöffel
- H **5595** TENEDOR LUNCH
cake fork, fourchette gâteau, forchetta dolce, kuchengabel
- I **5594** CUCHARA MOKA
coffee/moka spoon, cuillère moka, cucchiaio moka, mokkalöffel

- 5616** MAZO 2 CUCHILLO CHULETERO
film 2 steak knife, film 2 couteau steak, film 2 coltello bistecca, film 2 steakmesser
- 5617** MAZO 3 CUCHARA MESA
film 3 table spoon, film 3 cuillère table, film 3 cucchiaio tavola, film 3 löffel
- 5618** MAZO 3 TENEDOR MESA
film 3 table fork, film 3 fourchette table, film 3 forchetta tavola, film 3 tafelgabel
- 5619** MAZO 6 TENEDOR LUNCH
film 6 cake fork, film 6 fourchette gâteau, film 6 forchetta dolce, film 6 kuchengabel
- 5620** MAZO 6 CUCHARA CAFÉ
film 6 tea spoon, film 6 cuillère café, film 6 cucchiaio caffè, film 6 kaffeelöffel
- 5621** MAZO 6 CUCHARA MOKA
film 6 coffee/moka spoon, film 6 cuillère moka, film 6 cucchiaio moka, film 6 mokkalöffel

- 2894** 24 PIEZAS
24 pieces, écrin 24 pièces, bauletto 24 pz., 24 stück

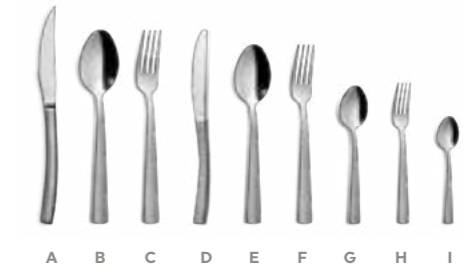

INOX STAINLESS STEEL 304

- A **7421** SET PALILLOS INOX
chopsticks set 18/10, set baguettes 18/10, set baguettes 18/10, essstäbchen set 18/10
- B **7422** SET PALILLOS BLACK
chopsticks set black 18/10, set baguettes black 18/10, set baguettes black 18/10, essstäbchen set 18/10 black
- C **7423** SET PALILLOS COPPER
chopsticks set copper 18/10, set baguettes copper 18/10, set baguettes copper 18/10, essstäbchen set 18/10 copper
- D **7424** SET PALILLOS GOLD
chopsticks set gold 18/10, set baguettes gold 18/10, set baguettes gold 18/10, essstäbchen set 18/10 gold
- E **7554** REPOSA PALILLOS BLOQUE SATIN
chopsticks rest satin 18/10, porte baguette satin 18/10, supporto posate satin 18/10, besteckhalter satin 18/10
- F **7555** REPOSA PALILLOS BLOQUE NEGRO
chopsticks rest black 18/10, porte baguette black 18/10, supporto posate black 18/10, besteckhalter black 18/10

UE	MOQ	✂ mm	✂ mm
0/12/120/1920/5760	12	230	11
0/12/120/1920/5760	12	230	11
0/12/120/1920/5760	12	230	11
0/12/120/1920/5760	12	230	11
0/12/120/1920/5760	12	60	11
0/12/120/1920/5760	12	60	

UE	MOQ	✂ mm	✂ mm
0/12/120/1920/5760	120	225	7
0/12/120/1440/7200	120	200	3
0/12/120/1440/7200	120	200	3
0/12/120/1920/5760	120	200	
0/12/120/1440/7200	120	184	2
0/12/120/1440/7200	120	184	2
0/12/120/2520/15120	120	142	2
0/12/120/2520/15120	120	145	2
0/12/120/2520/15120	120	110	1,8
1/0/48/1008/3024	48	225	
1/0/48/1200/3600	48	200	3
1/0/48/1200/3600	48	200	3
1/0/48/1152/4608	48	145	2
1/0/48/1152/4608	48	142	2
1/0/48/1152/4608	48	110	1,8
1/0/4	4		2,5

Hidraulic

INOX Nickel Free 18% / 3mm / Mirror

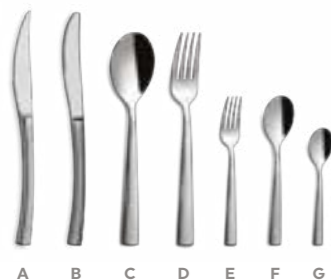

Hidraulic Black

INOX Nickel Free 18% / 3mm / Mirror



INOX
STAINLESS
STEEL
430

A	6464	CUCHILLO CHULETERO steak knife, couteau steak, coltello bistecca, steakmesser	0/12/120/1920/5760	120	220	
B	6326	CUCHILLO MESA table knife, couteau table, coltello tavola, tafelmesser	0/12/120/1920/5760	120	220	
C	6327	CUCHARA MESA table spoon, cuillère table, cucchiaio tavola, tafellöffel	0/12/120/1440/7200	120	200	3
D	6328	TENEDOR MESA table fork, fourchette table, forchetta tavola, tafelgabel	0/12/120/1440/7200	120	200	3
E	6329	TENEDOR LUNCH cake fork, fourchette gâteau, forchetta dolce, kuchengabel	0/12/120/2520/15120	120	140	2
F	6331	CUCHARA CAFÉ tea spoon, cuillère café, cucchiaio caffè, kaffeelöffel	0/12/120/2520/15120	120	140	2
G	6330	CUCHARA MOKA coffee/moka spoon, cuillère moka, cucchiaio moka, mokkalöffel	0/12/120/2520/15120	120	110	2
	6499	MAZO 2 CUCHILLO CHULETERO film 2 steak knife, film 2 couteau steak, film 2 coltello bistecca, film 2 steakmesser	1/0/48/1008/3024	48	220	
	6344	MAZO 2 CUCHILLO MESA film 2 table knife, film 2 couteau table, film 2 coltello tavola, film 2 tafelmesser	1/0/48/1008/3024	48	220	
	6345	MAZO 3 CUCHARA MESA film 3 table spoon, film 3 cuillère table, film 3 cucchiaio tavola, film 3 tafellöffel	1/0/48/1200/3600	48	200	3
	6346	MAZO 3 TENEDOR MESA film 3 table fork, film 3 fourchette table, film 3 forchetta tavola, film 3 tafelgabel	1/0/48/1200/3600	48	200	3
	6347	MAZO 6 TENEDOR LUNCH film 6 cake fork, film 6 fourchette gâteau, film 6 forchetta dolce, film 6 kuchengabel	1/0/48/1152/4608	48	140	2
	6348	MAZO 6 CUCHARA CAFÉ film 6 tea spoon, film 6 cuillère café, film 6 cucchiaio caffè, film 6 kaffeelöffel	1/0/48/1152/4608	48	140	2
	6349	MAZO 6 CUCHARA MOKA film 6 coffee/moka spoon, film 6 cuillère moka, film 6 cucchiaio moka, film 6 mokkalöffel	1/0/48/1152/4608	48	110	2
	6332	24 PIEZAS 24 pieces, écrin 24 pièces, bauletto 24 pz., 24 stück	1/0/4	4	3	

MOQ ▶ mm ✂ mm



INOX
STAINLESS
STEEL
430

A	7207	CUCHILLO MESA table knife, couteau table, coltello tavola, tafelmesser	0/12/120/1920/5760	60	220	
B	7208	CUCHARA MESA table spoon, cuillère table, cucchiaio tavola, tafellöffel	0/12/120/1440/7200	60	200	3
C	7209	TENEDOR MESA table fork, fourchette table, forchetta tavola, tafelgabel	0/12/120/1440/7200	60	200	3
D	7210	CUCHARA CAFÉ tea spoon, cuillère café, cucchiaio caffè, kaffeelöffel	0/12/120/2520/15120	60	140	2
	7211	24 PIEZAS 24 pieces, écrin 24 pièces, bauletto 24 pz., 24 stück	1/0/4	4	3	

UE MOQ ▶ mm ✂ mm



Madrid

INOX Nickel Free 18% / 3mm / Mirror

Madrid

INOX Nickel Free 18% / 3mm / Mirror



INOX
STAINLESS
STEEL
430

	UE	MOQ	▶ mm	✕ mm
A 1339 CUCHILLO CHULETERO steak knife, couteau steak, coltello bistecca, steakmesser	0/12/120/1920/5760	120	224	
B 2775 CUCHILLO MESA table knife, couteau table, coltello tavola, tafelmesser	0/12/120/1920/5760	120	221	
C 1340 CUCHARA MESA table spoon, cuillère table, cucchiaio tavola, tafellöffel	0/12/120/1440/7200	120	200	3
D 1341 TENEDOR MESA table fork, fourchette table, forchetta tavola, tafelgabel	0/12/120/1440/7200	120	200	3
E 6114 PALA PESCADO fish knife, couteau poisson, coltello pesce, fischmesser	0/12/120/1440/7200	120	200	3
F 9653 TENEDOR PESCADO fish fork, fourchette poisson, forchetta pesce, fischgabel	0/12/120/1440/7200	120	200	3
G 6115 CUCHILLO POSTRE dessert knife, couteau dessert, coltello frutta, dessertmesser	0/12/120/1920/5760	120	204	
H 1595 CUCHARA POSTRE dessert spoon, cuillère dessert, cucchiaio frutta, dessertlöffel	0/12/120/1440/7200	120	183	3
I 6117 TENEDOR POSTRE dessert fork, fourchette dessert, forchetta frutta, dessertgabel	0/12/120/1440/7200	120	185	3
J 9655 TENEDOR LUNCH cake fork, fourchette gâteau, forchetta dolce, kuchengabel	0/12/120/2520/15120	120	140	2
K 1342 CUCHARA CAFÉ tea spoon, cuillère café, cucchiaio caffè, kaffeelöffel	0/12/120/2520/15120	120	135	2
L 9654 CUCHARA MOKA coffee/moka spoon, cuillère moka, cucchiaio moka, mokkalöffel	0/12/120/2520/15120	120	110	2
M 1619 CAZO SOPA soup ladle, louche à potage, mestolo, suppenkelle	1/10/50/150/750	10	268	3
N 1620 CUCHARA ENSALADA salad spoon, cuillère à servir salade, cucchiaio servire, salatlöffel	1/10/50/800/4000	10	270	3
O 1622 TENEDOR ENSALADA salad fork, fourchette à servir salade, forchetta servire, salatgabel	1/10/50/800/4000	10	265	3
P 1621 PALA LASAÑA lasagna server, pelle à lasagne, pala lasagna, lasagneheber	1/10/50/600/2400	10	235	3
Q 1625 CAZO SALSAS sauce ladle, cuillère à sauce, mestolino salsa, soßenkelle	1/10/50/800/4000	10	180	3
1193 MAZO 2 CUCHILLO CHULETERO film 2 steak knife, film 2 couteau steak, film 2 coltello bistecca, film 2 steakmesser	1/0/48/1008/3024	48	224	
1194 MAZO 3 CUCHARA MESA film 3 table spoon, film 3 cuillère table, film 3 cucchiaio tavola, film 3 tafellöffel	1/0/48/1200/3600	48	200	3
1195 MAZO 3 TENEDOR MESA film 3 table fork, film 3 fourchette table, film 3 forchetta tavola, film 3 tafelgabel	1/0/48/1200/3600	48	200	3
1078 MAZO 2 CUCHILLO POSTRE film 2 dessert knife, film 2 couteau dessert, film 2 coltello frutta, film 2 dessertmesser	1/0/48/1008/3024	48	204	
1079 MAZO 3 CUCHARA POSTRE film 3 dessert spoon, film 3 cuillère dessert, film 3 cucchiaio frutta, film 3 dessertlöffel	1/0/48/1200/3600	48	183	3
1080 MAZO 3 TENEDOR POSTRE film 3 dessert fork, film 3 fourchette dessert, film 3 forchetta frutta, film 3 dessertgabel	1/0/48/1200/3600	48	185	3
1196 MAZO 6 TENEDOR LUNCH film 6 cake fork, film 6 fourchette gâteau, film 6 forchetta dolce, film 6 kuchengabel	1/0/48/1152/4608	48	140	2
1197 MAZO 6 CUCHARA CAFÉ film 6 tea spoon, film 6 cuillère café, film 6 cucchiaio caffè, film 6 kaffeelöffel	1/0/48/1152/4608	48	135	2
1198 MAZO 6 CUCHARA MOKA film 6 coffee/moka spoon, film 6 cuillère moka, film 6 cucchiaio moka, film 6 mokkalöffel	1/0/48/1152/4608	48	110	2



2895 24 PIEZAS
24 pieces, écriin 24 pièces, bauletto 24 pz., 24 stück

UE 1/0/4 MOQ 4 ▶ mm ✕ mm 2,5





INOX
STAINLESS
STEEL
430

A	2283	CUCHILLO MESA table knife, couteau table, coltello tavola, tafelmesser	0/12/120/1920/5760	120	240	
B	2274	CUCHARA MESA table spoon, cuillère table, cucchiaio tavola, tafellöffel	0/12/120/1440/7200	120	200	3
C	2275	TENEDOR MESA table fork, fourchette table, forchetta tavola, tafelgabel	0/12/120/1440/7200	120	200	3
D	2758	PALA PESCADO fish knife, couteau poisson, coltello pesce, fischmesser	0/12/120/1440/7200	120	206	3
E	2284	CUCHILLO POSTRE dessert knife, couteau dessert, coltello frutta, dessertmesser	0/12/120/1920/5760	120	210	
F	2759	CUCHARA POSTRE dessert spoon, cuillère dessert, cucchiaio frutta, dessertlöffel	0/12/120/1440/7200	120	180	3
G	2760	TENEDOR POSTRE dessert fork, fourchette dessert, forchetta frutta, dessertgabel	0/12/120/1440/7200	120	178	3
H	2761	TENEDOR LUNCH cake fork, fourchette gâteau, forchetta dolce, kuchengabel	0/12/120/2520/15120	120	137	2
I	2762	CUCHARA CAFÉ tea spoon, cuillère café, cucchiaio caffè, kaffeelöffel	0/12/120/2520/15120	120	134	2
J	2763	CUCHARA MOKA coffee/moka spoon, cuillère moka, cucchiaio moka, mokkalöffel	0/12/120/2520/15120	120	115	2
	M2283	MAZO 2 CUCHILLO MESA film 2 table knife, film 2 couteau table, film 2 coltello tavola, film 2 tafelmesser	1/0/48/1008/3024	48	240	
	M2274	MAZO 3 CUCHARA MESA film 3 table spoon, film 3 cuillère table, film 3 cucchiaio tavola, film 3 tafellöffel	1/0/48/1200/3600	48	200	3
	M2275	MAZO 3 TENEDOR MESA film 3 table fork, film 3 fourchette table, film 3 forchetta tavola, film 3 tafelgabel	1/0/48/1200/3600	48	200	3
	M5084	MAZO 2 CUCHILLO POSTRE film 2 dessert knife, film 2 couteau dessert, film 2 coltello frutta, film 2 dessertmesser	1/0/48/1008/3024	48	210	
	M2759	MAZO 3 CUCHARA POSTRE film 3 dessert spoon, film 3 cuillère dessert, film 3 cucchiaio frutta, film 3 dessertlöffel	1/0/48/1200/3600	48	180	3
	M2760	MAZO 3 TENEDOR POSTRE film 3 dessert fork, film 3 fourchette dessert, film 3 forchetta frutta, film 3 dessertgabel	1/0/48/1200/3600	48	178	3
	M2761	MAZO 6 TENEDOR LUNCH film 6 cake fork, film 6 fourchette gâteau, film 6 forchetta dolce, film 6 kuchengabel	1/0/48/1152/4608	48	137	2
	M2762	MAZO 6 CUCHARA CAFÉ film 6 tea spoon, film 6 cuillère café, film 6 cucchiaio caffè, film 6 kaffeelöffel	1/0/48/1152/4608	48	134	2
	M2763	MAZO 6 CUCHARA MOKA film 6 coffee/moka spoon, film 6 cuillère moka, film 6 cucchiaio moka, film 6 mokkalöffel	1/0/48/1152/4608	48	115	2

UE **MOQ** **▶ mm** **✂ mm**



2764 **24 PIEZAS**
24 pieces, écriin 24 pièces, bauletto 24 pz., 24 stück

UE **MOQ** **▶ mm** **✂ mm**
1/0/4 4 2,5





INOX
STAINLESS
STEEL
430

A	2774	CUCHILLO MESA table knife, couteau table, coltello tavola, tafelmesser
B	2710	CUCHARA MESA table spoon, cuillère table, cucchiaio tavola, tafellöffel
C	2711	TENEDOR MESA table fork, fourchette table, forchetta tavola, tafelgabel
D	2734	PALA PESCADO fish knife, couteau poisson, coltello pesce, fischmesser
E	5826	CUCHILLO POSTRE dessert knife, couteau dessert, coltello frutta, dessertmesser
F	2712	CUCHARA POSTRE dessert spoon, cuillère dessert, cucchiaio frutta, dessertlöffel
G	2713	TENEDOR POSTRE dessert fork, fourchette dessert, forchetta frutta, dessertgabel
H	2714	TENEDOR LUNCH cake fork, fourchette gâteau, forchetta dolce, kuchengabel
I	2715	CUCHARA CAFÉ tea spoon, cuillère café, cucchiaio caffè, kaffeelöffel
J	2716	CUCHARA MOKA coffee/moka spoon, cuillère moka, cucchiaio moka, mokkalöffel
	M2297	MAZO 2 CUCHILLO MESA film 2 table knife, film 2 couteau table, film 2 coltello tavola, film 2 tafelmesser
	M2710	MAZO 3 CUCHARA MESA film 3 table spoon, film 3 cuillère table, film 3 cucchiaio tavola, film 3 tafellöffel
	M2711	MAZO 3 TENEDOR MESA film 3 table fork, film 3 fourchette table, film 3 forchetta tavola, film 3 tafelgabel
	M2161	MAZO 2 CUCHILLO POSTRE film 2 dessert knife, film 2 couteau dessert, film 2 coltello frutta, film 2 dessertmesser
	M2712	MAZO 3 CUCHARA POSTRE film 3 dessert spoon, film 3 cuillère dessert, film 3 cucchiaio frutta, film 3 dessertlöffel
	M2713	MAZO 3 TENEDOR POSTRE film 3 dessert fork, film 3 fourchette dessert, film 3 forchetta frutta, film 3 dessertgabel
	M2714	MAZO 6 TENEDOR LUNCH film 6 cake fork, film 6 fourchette gâteau, film 6 forchetta dolce, film 6 kuchengabel
	M2715	MAZO 6 CUCHARA CAFÉ film 6 tea spoon, film 6 cuillère café, film 6 cucchiaio caffè, film 6 kaffeelöffel
	M2716	MAZO 6 CUCHARA MOKA film 6 coffee/moka spoon, film 6 cuillère moka, film 6 cucchiaio moka, film 6 mokkalö-

UE	MOQ	▶ mm	✂ mm
0/12/120/1920/5760	120	229	
0/12/120/1440/7200	120	213	3
0/12/120/1440/7200	120	213	3
0/12/120/1440/7200	120	215	2,5
0/12/120/1920/5760	60	200	
0/12/120/1440/7200	120	190	2,5
0/12/120/1440/7200	120	190	2,5
0/12/120/2520/15120	120	140	2
0/12/120/2520/15120	120	140	2
0/12/120/2520/15120	120	109	1,5
1/0/48/1008/3024	48	229	
1/0/48/1200/3600	48	213	3
1/0/48/1200/3600	48	213	3
1/0/48/1008/3024	48	200	
1/0/48/1200/3600	48	190	2,5
1/0/48/1200/3600	48	190	2,5
1/0/48/1152/4608	48	140	2
1/0/48/1152/4608	48	140	2
1/0/48/1152/4608	48	109	1,5



2757 24 PIEZAS
24 pieces, écriin 24 pièces, bauiletto 24 pz., 24 stück

UE	MOQ	▶ mm	✂ mm
1/0/4	4		3



Napoli Pizza Collection

INOX Nickel Free 18% / 4mm / Mirror



INOX STAINLESS STEEL 430

- A **3263** CUCHILLO PIZZA
pizza knife, couteau pizza, coltello pizza, pizza tafelmesser
- B **3264** TENEDOR PIZZA
pizza fork, fourchette pizza, forchetta pizza, pizza gabel
- C **3265** BLISTER 3 CUCHILLO PIZZA
blister 3 pizza knife, blister 3 couteau pizza, blister 3 coltello pizza, blister pizza-messer
- D **3266** BLISTER CUCHILLO + TENEDOR PIZZA
blister pizza knife + fork, blister couteau + fourchette pizza, blister coltello + forchetta pizza, blister pizza messer + gabel

UE	MOQ	▶ mm	✂ mm
0/12/120/1920/5760	120	205	
0/12/120/1920/5760	120	202	4
1/0/24/4561/2280	24	205	
1/0/48/576/2304	48	205	4

Vieux Paris

INOX Nickel Free 18% / 3mm / Mirror + Satin



Acabado mirror
Mirror finish

Acabado satinado
Satin finish

INOX STAINLESS STEEL 430

- A **5795** CUCHILLO MESA
table knife, couteau table, coltello tavola, tafelmesser
- B **5796** CUCHARA MESA
table spoon, cuillère table, cucchiaio tavola, tafellöffel
- C **5797** TENEDOR MESA
table fork, fourchette table, forchetta tavola, tafelgabel
- D **5798** CUCHILLO POSTRE
dessert knife, couteau dessert, coltello frutta, dessertmesser
- E **5799** CUCHARA POSTRE
dessert spoon, cuillère dessert, cucchiaio frutta, dessertlöffel
- F **5800** TENEDOR POSTRE
dessert fork, fourchette dessert, forchetta frutta, dessertgabel
- G **5801** CUCHARA CAFÉ
tea spoon, cuillère café, cucchiaio caffè, kaffeelöffel
- H **5802** CUCHARA MOKA
coffee/moka spoon, cuillère moka, cucchiaio moka, mokkalöffel

UE	MOQ	▶ mm	✂ mm
0/12/120/1920/5760	60	238	
0/12/120/1440/7200	60	210	3
0/12/120/1440/7200	60	208	3
0//120/1920/5760	60	215	
0/12/120/1440/7200	60	178	2,5
0/12/120/1440/7200	60	178	2,5
0/12/120/2520/15120	60	143	2
0/12/120/2520/15120	60	112	2

Sevilla XL

INOX Nickel Free 18% / 3mm / Mirror



Sevilla XL

INOX Nickel Free 18% / 3mm / Mirror



	UP					
A	0094	CUCHILLO MESA	0/12/120/1920/5760	60	225	
		table knife, couteau table, coltello tavola, tafelmesser				
B	5631	CUCHILLO CHULETERO	0/12/120/1920/5760	60	230	
		steak knife, couteau steak, coltello bistecca, steakmesser				
C	9657	CUCHARA MESA	0/12/120/1440/7200	120	209	3
		table spoon, cuillère table, cucchiaio tavola, tafellöffel				
D	9658	TENEDOR MESA	0/12/120/1440/7200	120	210	3
		table fork, fourchette table, forchetta tavola, tafelgabel				
E	9659	PALA PESCADO	0/12/120/1440/7200	120	200	2,5
		fish knife, couteau poisson, coltello pesce, fischmesser				
F	9660	TENEDOR PESCADO	0/12/120/1440/7200	120	197	2,5
		fish fork, fourchette poisson, forchetta pesce, fischgabel				
G	0099	CUCHILLO POSTRE	0/12/120/1920/5760	60	195	
		dessert knife, couteau dessert, coltello frutta, dessertmesser				
H	9662	CUCHARA POSTRE	0/12/120/1440/7200	120	178	2,5
		dessert spoon, cuillère à dessert, cucchiaio frutta, dessertlöffel				
I	9663	TENEDOR POSTRE	0/12/120/1440/7200	120	183	2,5
		dessert fork, fourchette à dessert, forchetta frutta, dessertgabel				
J	11930	TENEDOR LUNCH	0/12/120/2520/15120	120	148	2
		cake fork, fourchette gâteau, forchetta dolce, kuchengabel				
K	9665	CUCHARA CAFÉ	0/12/120/2520/15120	120	138	2
		tea spoon, cuillère café, cucchiaio caffè, kaffeelöffel				
L	9666	CUCHARA MOKA	0/12/120/2520/15120	120	117	2
		coffee/moka spoon, cuillère moka, cucchiaio moka, mokkalöffel				
M	1626	CAZO SOPA	1/10/50/200/800	10	260	2,5
		soup ladle, louche à potage, mestolo, suppenkelle				
N	1627	CUCHARA SERVIR	1/10/50/800/400	10	235	2,5
		serving spoon, cuillère à servir, cucchiaio servir, servierlöffel				
O	1628	TENEDOR SERVIR	1/10/50/800/400	10	235	2,5
		serving fork, fourchette à servir, forchetta servire, serviergabel				
P	1629	PALA REPOSTERÍA	1/10/50/600/2400	10	240	2,7
		cake server, pelle à tarte, pala torta, tortenheber				
Q	1632	CAZO SALSA	1/10/50/800/4000	10	170	2,7
		sauce ladle, cuillère à sauce, mestolino salsa, soßenkelle				



1297	MAZO 2 CUCHILLO CHULETERO	0/48/1008/3024	48	230		
	film 2 steak knife, film 2 couteau steak, film 2 coltello bistecca, film 2 steakmesser					
1298	MAZO 3 CUCHARA MESA	1/0/48/1200/3600	48	209	3	
	film 3 table spoon, film 3 cuillère table, film 3 cucchiaio tavola, film 3 tafellöffel					
1299	MAZO 3 TENEDOR MESA	1/0/48/1200/3600	48	210	3	
	film 3 table fork, film 3 fourchette table, film 3 forchetta tavola, film 3 tafelgabel					
1315	MAZO 2 CUCHILLO POSTRE	1/0/48/1008/3024	48	200		
	film 2 dessert knife, film 2 couteau dessert, film 2 coltello frutta, film 2 dessertmesser					
1316	MAZO 3 CUCHARA POSTRE	1/0/48/1200/3600	48	178	2,5	
	film 3 dessert spoon, film 3 cuillère à dessert, film 3 cucchiaio frutta, film 3 dessertlöffel					
1317	MAZO 3 TENEDOR POSTRE	1/0/48/1200/3600	48	183	2,5	
	film 3 dessert fork, film 3 fourchette à dessert, film 3 forchetta frutta, film 3 dessertgabel					
NEW 11931	MAZO 6 TENEDOR LUNCH	1/0/48/1152/4608	48	178	2	
	film 6 cake fork, film 6 fourchette gâteau, film 6 forchetta dolce, film 6 kuchengabel					
1301	MAZO 6 CUCHARA CAFÉ	1/0/48/1152/4608	48	138	2	
	film 6 tea spoon, film 6 cuillère café, film 6 cucchiaio caffè, film 6 kaffeelöffel					
1302	MAZO 6 CUCHARA MOKA	1/0/48/1152/4608	48	117	2	
	film 6 coffee/moka spoon, film 6 cuillère moka, film 6 cucchiaio moka, film 6 mokkalöffel					



Sevilla S

INOX Nickel Free 18% / 1,8mm / Mirror



UE MOQ \llcorner mm \times mm

A	4712	CUCHILLO MESA MICRODENTADO table knife micro, couteau table micro, coltello tavola micro, tafelmesser micro	0/12/120/1920/5760	120	224	
B	0451	CUCHARA MESA table spoon, cuillère table, cucchiaio tavola, tafellöffel	0/12/120/1440/7200	120	193	1,5
C	0452	TENEDOR MESA table fork, fourchette table, forchetta tavola, tafelgabel	0/12/120/1440/7200	120	190	1,8
D	0453	TENEDOR LUNCH cake fork, fourchette gâteau, forchetta dolce, kuchengabel	0/12/120/2520/15120	120	143	1,5
E	0454	CUCHARA CAFÉ tea spoon, cuillère café, cucchiaio caffè, kaffeelöffel	0/12/120/2520/15120	120	140	1,5
F	0455	CUCHARA MOKA coffee/moka spoon, cuillère moka, cucchiaio moka, mokkalöffel	0/12/120/2520/15120	120	120	1,2
M3950		MAZO 2 CUCHILLO MESA MICRO film 2 table knife micro, film 2 couteau table micro, film 2 coltello tavola micro, film 2 tafelmesser micro	1/0/48/1008/3024	48	224	
M4306		MAZO 3 CUCHARA MESA film 3 table spoon, film 3 cuillère table, film 3 cucchiaio tavola, film 3 tafellöffel	1/0/48/1200/3600	48	193	1,5
M4307		MAZO 3 TENEDOR MESA film 3 table fork, film 3 fourchette table, film 3 forchetta tavola, film 3 tafelgabel	1/0/48/1200/3600	48	190	1,8
M4755		MAZO 6 TENEDOR LUNCH film 6 cake fork, film 6 fourchette gâteau, film 6 forchetta dolce, film 6 kuchengabel	1/0/48/1152/4608	48	143	1,5
M4756		MAZO 6 CUCHARA CAFÉ film 6 tea spoon, film 6 cuillère café, film 6 cucchiaio caffè, film 6 kaffeelöffel	1/0/48/1152/4608	48	140	1,5
M4757		MAZO 6 CUCHARA MOKA film 6 coffee/moka spoon, film 6 cuillère moka, film 6 cucchiaio moka, film 6 mokkalöffel	1/0/48/1152/4608	48	120	1,2
3950		CORBATA 2 CUCHILLO MESA ECO MICRO Tie 2 table knife eco micro, cavalier 2 couteau table eco micro, cravatta 2 coltello tavola eco micro, krawatte 2 tafelmesser eco micro	1/4/48/672/2688	48	224	
4306		CORBATA 3 CUCHARA MESA Tie 3 table spoon, cavalier 3 cuillère table, cravatta 3 cucchiaio tavola, krawatte 3 takkellöffel	1/4/48/672/2688	48	193	1,5
4307		CORBATA 3 TENEDOR MESA Tie 3 table fork, cavalier 3 fourchette table, cravatta 3 forchetta tavola, krawatte 3 tafelgabel	1/4/48/672/2688	48	190	1,8
4755		CORBATA 6 TENEDOR LUNCH Tie 6 cake fork, cavalier 6 fourchette gâteau, cravatta 6 forchetta dolce, krawatte 6 kuchengabel	1/4/48/672/2688	48	143	1,5
4756		CORBATA 6 CUCHARA CAFÉ Tie 6 tea spoon, cavalier 6 cuillère café, cravatta 6 cucchiaio caffè, krawatte 6 kaffeelöffel	1/4/48/672/2688	48	140	1,5
4757		CORBATA 6 CUCHARA MOKA Tie 6 moka spoon, cavalier 6 cuillère moka, cravatta 6 cucchiaio moka, krawatte 6 mokkalöffel	1/4/48/672/2688	48	120	1,2
4885		24 PIEZAS 24 pieces, écriin 24 pièces, bauletto 24 pz., 24 stück	1/0/4	4	1,8	
4999		24 PIEZAS CON CHULETERO 24 pieces + stak knife, écriin 24 pièces + c.steak, bauletto 24 pz. + bistecca, 24 stück + steakmesser	1/0/4	4	1,8	

Sevilla Vintage

INOX Nickel Free 18% / 2,5mm / Vintage



UE MOQ \llcorner mm \times mm

A	7425	CUCHILLO MESA table knife, couteau table, coltello tavola, tafelmesser	0/12/120/1920/5760	120	225	
B	7426	CUCHARA MESA table spoon, cuillère table, cucchiaio tavola, tafellöffel	0/12/120/1440/7200	120	198	2,5
C	7427	TENEDOR MESA table fork, fourchette table, forchetta tavola, tafelgabel	0/12/120/1440/7200	120	198	2,5
D	8567	PALA PESCADO fish knife, couteau poisson, coltello pesce, fischmesser	0/12/120/1440/7200	120	200	2,5
E	8568	CUCHILLO POSTRE dessert knife, couteau dessert, coltello frutta, dessertmesser	0/12/120/1440/7200	120	195	
F	8569	CUCHARA POSTRE dessert spoon, cuillère à dessert, cucchiaio frutta, dessertlöffel	0/12/120/1440/7200	120	185	2,5
G	8570	TENEDOR POSTRE dessert fork, fourchette à dessert, forchetta frutta, dessertgabel	0/12/120/1440/7200	120	185	2,5
H	11932	TENEDOR LUNCH cake fork, fourchette gâteau, forchetta dolce, kuchengabel	0/12/120/2520/15120	120	148	2
I	7429	CUCHARA CAFÉ tea spoon, cuillère café, cucchiaio caffè, kaffeelöffel	0/12/120/2520/15120	120	138	2
J	7430	CUCHARA MOKA coffee/moka spoon, cuillère moka, cucchiaio moka, mokkalöffel	0/12/120/2520/15120	120	117	2
7917		24 PIEZAS 24 pieces, écriin 24 pièces, bauletto 24 pz., 24 stück	1/0/4	4	1,8	

Granada XL

INOX Nickel Free 18% / 2,5mm / Mirror



Granada XL

INOX Nickel Free 18% / 2,5mm / Mirror



	€	UE	MOQ	✂ mm	✂ mm
A 1283 CUCHILLO CHULETERO steak knife, couteau steak, coltello bistecca, steakmesser	2,43 €	0/12/120/1920/5760	60	223	
B 3522 CUCHILLO MESA table knife, couteau table, coltello tavola, tafelmesser	2,43 €	0/12/120/1920/5760	60	225	
UP C 2700 CUCHARA MESA table spoon, cuillère table, cucchiaio tavola, tafellöffel	1,61 €	0/12/120/1440/7200	120	209	2,5
UP D 2701 TENEDOR MESA table fork, fourchette table, forchetta tavola, tafelgabel	1,61 €	0/12/120/1440/7200	120	210	2,5
E 2702 PALA PESCADO fish knife, couteau poisson, coltello pesce, fischmesser	1,53 €	0/12/120/1440/7200	120	200	2,5
F 2703 TENEDOR PESCADO fish fork, fourchette poisson, forchetta pesce, fischgabel	1,53 €	0/12/120/1440/7200	120	200	2,5
G 3523 CUCHILLO POSTRE dessert knife, couteau dessert, coltello frutta, dessertmesser	2,23 €	0/12/120/1920/5760	120	196	
H 2705 CUCHARA POSTRE dessert spoon, cuillère à dessert, cucchiaio frutta, dessertlöffel	1,53 €	0/12/120/1440/7200	120	178	2,5
I 2706 TENEDOR POSTRE dessert fork, fourchette à dessert, forchetta frutta, dessertgabel	1,53 €	0/12/120/1440/7200	120	183	2,5
NEW J 11933 TENEDOR LUNCH cake fork, fourchette gâteau, forchetta dolce, kuchengabel	0,91 €	0/12/120/2520/15120	120	148	2
UP K 2708 CUCHARA CAFÉ tea spoon, cuillère café, cucchiaio caffè, kaffeelöffel	0,91 €	0/12/120/2520/15120	120	138	2
UP L 2709 CUCHARA MOKA coffee/moka spoon, cuillère moka, cucchiaio moka, mokkalöffel	0,89 €	0/12/120/2520/15120	120	117	2
M 2303 CAZO SOPA soup ladle, louche à potage, mestolo, suppenkelle	5,65 €	1/10/50/150/750	10	260	2,5
N 2304 CUCHARA SERVIR serving spoon, cuillère à servir, cucchiaio servir, servierlöffel	4,18 €	1/10/50/?800?4000	10	230	2,8
O 2305 TENEDOR SERVIR serving fork, fourchette à servir, forchetta servire, serviergabel	4,18 €	1/10/50/?800?4000	10	230	2,5
P 2306 PALA REPOSTERÍA cake server, pelle à tarte, pala torta, tortenheber	4,61 €	1/10/50/600/2400	10	240	2,7
Q 2307 CAZO SALSA sauce ladle, cuillère à sauce, mestolino salsa, soßenkelle	5,53 €	1/10/50/800/4000	10	170	2,7



	UE	MOQ	✂ mm	✂ mm
M1462 MAZO 2 CUCHILLO CHULETERO film 2 steak knife, film 2 couteau steak, film 2 coltello bistecca, film 2 steakmesser	1/0/48/1008/3024	48	223	
1597 MAZO 3 CUCHARA MESA film 3 table spoon, film 3 cuillère table, film 3 cucchiaio tavola, film 3 tafellöffel	1/0/48/1200/3600	48	209	2,5
1598 MAZO 3 TENEDOR MESA film 3 table fork, film 3 fourchette table, film 3 forchetta tavola, film 3 tafelgabel	1/0/48/1200/3600	48	210	2,5
M4564 MAZO 2 CUCHILLO POSTRE film 2 dessert knife, film 2 couteau dessert, film 2 coltello frutta, film 2 dessertmesser	1/0/48/1008/3024	48	196	
1601 MAZO 3 CUCHARA POSTRE film 3 dessert spoon, film 3 cuillère à dessert, film 3 cucchiaio frutta, film 3 dessertlöffel	1/0/48/1200/3600	48	178	2,5
1602 MAZO 3 TENEDOR POSTRE film 3 dessert fork, film 3 fourchette à dessert, film 3 forchetta frutta, film 3 dessertgabel	1/0/48/1200/3600	48	183	2,5
NEW 11934 MAZO 6 TENEDOR LUNCH film 6 cake fork, film 6 fourchette gâteau, film 6 forchetta dolce, film 6 kuchengabel	1/0/48/1152/4608	48	145	2
1604 MAZO 6 CUCHARA CAFÉ film 6 tea spoon, film 6 cuillère café, film 6 cucchiaio caffè, film 6 kaffeelöffel	1/0/48/1152/4608	48	138	2
1605 MAZO 6 CUCHARA MOKA film 6 coffee/moka spoon, film 6 cuillère moka, film 6 cucchiaio moka, film 6 mokkalöffel	1/0/48/1152/4608	48	117	2

Granada S

INOX Nickel Free 18% / 1,8mm / Mirror

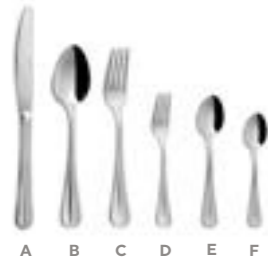

Granada S

INOX Nickel Free 18% / 1,8mm / Mirror

INOX
STAINLESS
STEEL
430

A	4632	CUCHILLO MESA table knife, couteau table, coltello tavola, tafelmesser
B	0424	CUCHARA MESA table spoon, cuillère table, cucchiaio tavola, tafellöffel
C	0425	TENEDOR MESA table fork, fourchette table, forchetta tavola, tafelgabel
D	0426	TENEDOR LUNCH cake fork, fourchette gâteau, forchetta dolce, kuchengabel
E	0427	CUCHARA CAFÉ tea spoon, cuillère café, cucchiaio caffè, kaffeelöffel
F	0428	CUCHARA MOKA coffee/moka spoon, cuillère moka, cucchiaio moka, mokkalöffel
	8083	MAZO 2 CUCHILLO MESA film 2 knife, film 2 couteau, film 2 coltello, film 2 messer
	8084	MAZO 3 CUCHARA MESA film 3 table spoon, film 3 cuillère table, film 3 cucchiaio tavola, film 3 tafellöffel
	8085	MAZO 3 TENEDOR MESA film 3 table fork, film 3 fourchette table, film 3 forchetta tavola, film 3 tafelgabel
	8086	MAZO 6 TENEDOR LUNCH film 6 cake fork, film 6 fourchette gâteau, film 6 forchetta dolce, film 6 kuchengabel
	8087	MAZO 6 CUCHARA CAFÉ film 6 tea spoon, film 6 cuillère café, film 6 cucchiaio caffè, film 6 kaffeelöffel
	8088	MAZO 6 CUCHARA MOKA film 6 coffee/moka spoon, film 6 cuillère moka, film 6 cucchiaio moka, film 6 mokkalöffel
	5107	CORBATA 2 CUCHILLO MESA Tie 2 table knife, cavalier 2 couteau table, cravatta 2 coltello tavola, krawatte 2 tafelmesser
	4623	CORBATA 3 CUCHARA MESA Tie 3 table spoon, cavalier 3 cuillère table, cravatta 3 cucchiaio tavola, krawatte 3 takkellöffel
	4624	CORBATA 3 TENEDOR MESA Tie 3 table fork, cavalier 3 fourchette table, cravatta 3 forchetta tavola, krawatte 3 tafelgabel
	3515	CORBATA 6 TENEDOR LUNCH Tie 6 cake fork, cavalier 6 fourchette gâteau, cravatta 6 forchetta dolce, krawatte 6 kuchengabel
	3516	CORBATA 6 CUCHARA CAFÉ Tie 6 tea spoon, cavalier 6 cuillère café, cravatta 6 cucchiaio caffè, krawatte 6 kaffeelöffel
	3517	CORBATA 6 CUCHARA MOKA Tie 6 moka spoon, cavalier 6 cuillère moka, cravatta 6 cucchiaio moka, krawatte 6 mokkalöffel
4884		24 PIEZAS 24 pieces, écrin 24 pièces, bauletto 24 pz., 24 stück

UE	MOQ	▶ mm	✂ mm
0/12/120/1920/5760	120	224	
0/12/120/1440/7200	120	193	1,5
0/12/120/1440/7200	120	190	1,8
0/12/120/2520/15120	120	143	1,5
0/12/120/2520/15120	120	140	1,5
0/12/120/2520/15120	120	120	1,2
1/0/48/1008/3024	48	224	
1/0/48/1200/3600	48	193	1,5
1/0/48/1200/3600	48	190	1,8
1/0/48/1152/4608	48	143	1,5
1/0/48/1152/4608	48	140	1,5
1/0/48/1152/4608	48	120	1,2
1/4/48/672/2688	48	224	
1/4/48/672/2688	48	193	1,5
1/4/48/672/2688	48	190	1,8
1/4/48/672/2688	48	143	1,5
1/4/48/672/2688	48	140	1,5
1/4/48/672/2688	48	120	1,2
1/0/4	4		1,8



Bilbao XL

INOX Nickel Free 18% / 2,5mm / Mirror



INOX STAINLESS STEEL 430

A	2396	CUCHILLO CHULETERO steak knife, couteau steak, coltello bistecca, steakmesser
B	2338	CUCHILLO MESA table knife, couteau table, coltello tavola, tafelmesser
C	2632	CUCHARA MESA table spoon, cuillère table, cucchiaio tavola, tafellöffel
D	2633	TENEDOR MESA table fork, fourchette table, forchetta tavola, tafelgabel
E	2634	PALA PESCADO fish knife, couteau poisson, coltello pesce, fischmesser
F	2635	TENEDOR PESCADO fish fork, fourchette poisson, forchetta pesce, fischgabel
G	2511	CUCHILLO POSTRE dessert knife, couteau dessert, coltello frutta, dessertmesser
H	2637	CUCHARA POSTRE dessert spoon, cuillère à dessert, cucchiaio frutta, dessertlöffel
I	2638	TENEDOR POSTRE dessert fork, fourchette à dessert, forchetta frutta, dessertgabel
J	11928	TENEDOR LUNCH cake fork, fourchette gâteau, forchetta dolce, kuchengabel
K	2640	CUCHARA CAFÉ tea spoon, cuillère café, cucchiaio caffè, kaffeelöffel
L	2641	CUCHARA MOKA coffee/moka spoon, cuillère moka, cucchiaio moka, mokkalöffel
M	2298	CAZO SOPA soup ladle, louche à potage, mestolo, suppenkelle
N	2040	CUCHARA SERVIR serving spoon, cuillère à servir, cucchiaio servir, servierlöffel
O	2300	TENEDOR SERVIR serving fork, fourchette à servir, forchetta servire, serviergabel
P	2301	PALA REPOSTERÍA cake server, pelle à tarte, pala torta, tortenheber
Q	2302	CAZO SALSA sauce ladle, cuillère à sauce, mestolino salsa, soßenkelle

UP
GRADE

Bilbao XL

INOX Nickel Free 18% / 2,5mm / Mirror



INOX STAINLESS STEEL 430

A	M2397	MAZO 2 CUCHILLO CHULETERO film 2 steak knife, film 2 couteau steak, film 2 coltello bistecca, film 2 steakmesser
C	1635	MAZO 3 CUCHARA MESA film 3 table spoon, film 3 cuillère table, film 3 cucchiaio tavola, film 3 tafellöffel
D	1642	MAZO 3 TENEDOR MESA film 3 table fork, film 3 fourchette table, film 3 forchetta tavola, film 3 tafelgabel
G	M4591	MAZO 2 CUCHILLO POSTRE film 2 dessert knife, film 2 couteau dessert, film 2 coltello frutta, film 2 dessertmesser
H	1644	MAZO 3 CUCHARA POSTRE film 3 dessert spoon, film 3 cuillère à dessert, film 3 cucchiaio frutta, film 3 dessertlöffel
I	1646	MAZO 3 TENEDOR POSTRE film 3 dessert fork, film 3 fourchette à dessert, film 3 forchetta frutta, film 3 dessertgabel
J	11929	MAZO 6 TENEDOR LUNCH film 6 cake fork, film 6 fourchette gâteau, film 6 forchetta dolce, film 6 kuchengabel
K	1648	MAZO 6 CUCHARA CAFÉ film 6 tea spoon, film 6 cuillère café, film 6 cucchiaio caffè, film 6 kaffeelöffel
L	1649	MAZO 6 CUCHARA MOKA film 6 coffee/moka spoon, film 6 cuillère moka, film 6 cucchiaio moka, film 6 mokkalöffel

UE	MOQ	▶ mm	✂ mm
1/0/48/1008/3024	48	223	
1/0/48/1200/3600	48	209	2,5
1/0/48/1200/3600	48	210	2,5
1/0/48/1008/3024	48	200	
1/0/48/1200/3600	48	178	2,5
1/0/48/1200/3600	48	183	2,5
1/0/48/1152/4608	48	148	2
1/0/48/1152/4608	48	138	2
1/0/48/1152/4608	48	117	2



Bilbao S

INOX Nickel Free 18% / 1,8mm / Mirror



Olympia

INOX Nickel Free 18% / 1,8mm / Mirror

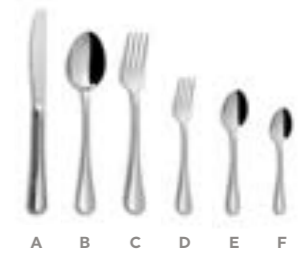

INOX
STAINLESS
STEEL
430

	UE	MOQ	▶ mm	✂ mm
A 1623 CUCHILLO MESA table knife, couteau table, coltello tavola, tafelmesser	0/12/120/1920/5760	120	224	
B 3130 CUCHARA MESA table spoon, cuillère table, cucchio tavola, tafellöffel	0/12/120/1440/7200	120	193	1,5
C 3131 TENEDOR MESA table fork, fourchette table, forchetta tavola, tafelgabel	0/12/120/1440/7200	120	190	1,8
D 3814 TENEDOR LUNCH cake fork, fourchette gâteau, forchetta dolce, kuchengabel	0/12/120/2520/15120	120	143	1,5
E 3812 CUCHARA CAFÉ tea spoon, cuillère café, cucchio caffè, kaffeelöffel	0/12/120/2520/15120	120	140	1,5
F 3813 CUCHARA MOKA coffee/moka spoon, cuillère moka, cucchio moka, mokkalöffel	0/12/120/2520/15120	120	120	1,2
M0010 MAZO 2 CUCHILLO MESA film 2 knife, film 2 couteau, film 2 coltello, film 2 messer	1/0/48/1008/3024	48	224	
M3435 MAZO 3 CUCHARA MESA film 3 table spoon, film 3 cuillère table, film 3 cucchio tavola, film 3 tafellöffel	1/0/48/1200/3600	48	193	1,5
M3970 MAZO 3 TENEDOR MESA film 3 table fork, film 3 fourchette table, film 3 forchetta tavola, film 3 tafelgabel	1/0/48/1200/3600	48	190	1,8
M4540 MAZO 6 TENEDOR LUNCH film 6 cake fork, film 6 fourchette gâteau, film 6 forchetta dolce, film 6 kuchengabel	1/0/48/1152/4608	48	143	1,5
M4541 MAZO 6 CUCHARA CAFÉ film 6 tea spoon, film 6 cuillère café, film 6 cucchio caffè, film 6 kaffeelöffel	1/0/48/1152/4608	48	140	1,5
M4542 MAZO 6 CUCHARA MOKA film 6 coffee/moka spoon, film 6 cuillère moka, film 6 cucchio moka, film 6 mokkalöffel	1/0/48/1152/4608	48	120	1,2
0010 CORBATA 2 CUCHILLO MESA Tie 2 table knife, cavalier 2 couteau table, cravatta 2 coltello tavola, krawatte 2 tafelmesser	1/4/48/672/2688	48	224	
3435 CORBATA 3 CUCHARA MESA Tie 3 table spoon, cavalier 3 cuillère table, cravatta 3 cucchio tavola, krawatte 3 takkelöffel	1/4/48/672/2688	48	193	1,5
3970 CORBATA 3 TENEDOR MESA Tie 3 table fork, cavalier 3 fourchette table, cravatta 3 forchetta tavola, krawatte 3 tafelgabel	1/4/48/672/2688	48	190	1,8
4540 CORBATA 6 TENEDOR LUNCH Tie 6 cake fork, cavalier 6 fourchette gâteau, cravatta 6 forchetta dolce, krawatte 6 kuchengabel	1/4/48/672/2688	48	143	1,5
4541 CORBATA 6 CUCHARA CAFÉ Tie 6 tea spoon, cavalier 6 cuillère café, cravatta 6 cucchio caffè, krawatte 6 kaffeelöffel	1/4/48/672/2688	48	140	1,5
4542 CORBATA 6 CUCHARA MOKA Tie 6 moka spoon, cavalier 6 cuillère moka, cravatta 6 cucchio moka, krawatte 6 mokkalöffel	1/4/48/672/2688	48	120	1,2
2455 24 PIEZAS 24 pieces, écrin 24 pièces, bauletto 24 pz., 24 Stück	1/0/4	4	1,8	

INOX
STAINLESS
STEEL
430

	UE	MOQ	▶ mm	✂ mm
A 1934 CORBATA 2 CUCHILLO MESA Tie 2 table knife, cavalier 2 couteau table, cravatta 2 coltello tavola, krawatte 2 tafelmesser	1/4/48/672/2688	48	224	
B 3976 CORBATA 3 CUCHARA MESA Tie 3 table spoon, cavalier 3 cuillère table, cravatta 3 cucchio tavola, krawatte 3 takkelöffel	1/4/48/672/2688	48	193	1,5
C 3771 CORBATA 3 TENEDOR MESA Tie 3 table fork, cavalier 3 fourchette table, cravatta 3 forchetta tavola, krawatte 3 tafelgabel	1/4/48/672/2688	48	190	1,8
D 4539 CORBATA 6 TENEDOR LUNCH Tie 6 cake fork, cavalier 6 fourchette gâteau, cravatta 6 forchetta dolce, krawatte 6 kuchengabel	1/4/48/672/2688	48	143	1,5
E 2555 CORBATA 6 CUCHARA CAFÉ Tie 6 tea spoon, cavalier 6 cuillère café, cravatta 6 cucchio caffè, krawatte 6 kaffeelöffel	1/4/48/672/2688	48	140	1,5
F 4556 CORBATA 6 CUCHARA MOKA Tie 6 moka spoon, cavalier 6 cuillère moka, cravatta 6 cucchio moka, krawatte 6 mokkalöffel	1/4/48/672/2688	48	120	1,2
2458 24 PIEZAS 24 pieces, écrin 24 pièces, bauletto 24 pz., 24 Stück	1/0/4	4	1,8	

	UE	MOQ	▶ mm	✂ mm
A 1934 CORBATA 2 CUCHILLO MESA Tie 2 table knife, cavalier 2 couteau table, cravatta 2 coltello tavola, krawatte 2 tafelmesser	1/4/48/672/2688	48	224	
B 3976 CORBATA 3 CUCHARA MESA Tie 3 table spoon, cavalier 3 cuillère table, cravatta 3 cucchio tavola, krawatte 3 takkelöffel	1/4/48/672/2688	48	193	1,5
C 3771 CORBATA 3 TENEDOR MESA Tie 3 table fork, cavalier 3 fourchette table, cravatta 3 forchetta tavola, krawatte 3 tafelgabel	1/4/48/672/2688	48	190	1,8
D 4539 CORBATA 6 TENEDOR LUNCH Tie 6 cake fork, cavalier 6 fourchette gâteau, cravatta 6 forchetta dolce, krawatte 6 kuchengabel	1/4/48/672/2688	48	143	1,5
E 2555 CORBATA 6 CUCHARA CAFÉ Tie 6 tea spoon, cavalier 6 cuillère café, cravatta 6 cucchio caffè, krawatte 6 kaffeelöffel	1/4/48/672/2688	48	140	1,5
F 4556 CORBATA 6 CUCHARA MOKA Tie 6 moka spoon, cavalier 6 cuillère moka, cravatta 6 cucchio moka, krawatte 6 mokkalöffel	1/4/48/672/2688	48	120	1,2
2458 24 PIEZAS 24 pieces, écrin 24 pièces, bauletto 24 pz., 24 Stück	1/0/4	4	1,8	



A B C D E F G H

INOX
STAINLESS
STEEL
430

A	2454	CUCHILLO CHULETERO steak knife, couteau steak, coltello bistecca, steakmesser	0/12/120/1920/5760	120	225	
B	1613	CUCHILLO MESA ECO table knife, couteau table, coltello tavola, tafelmesser	0/12/120/1920/5760	120	225	
C	2816	CUCHARA MESA table spoon, cuillère table, cucchiaio tavola, tafellöffel	0/12/120/1440/7200	120	203	1,5
D	2817	TENEDOR MESA table fork, fourchette table, forchetta tavola, tafelgabel	0/12/120/1440/7200	120	208	2
E	0021	CUCHILLO LUNCH cake knife, couteau gâteau, coltello dolce, kuchenmesser	0/12/120/1920/5760	120	165	
F	1825	TENEDOR LUNCH cake fork, fourchette gâteau, forchetta dolce, kuchengabel	0/12/120/2520/15120	120	145	1,5
G	1826	CUCHARA CAFÉ tea spoon, cuillère café, cucchiaio caffè, kaffeelöffel	0/12/120/2520/15120	120	140	1,5
H	1827	CUCHARA MOKA coffee/moka spoon, cuillère moka, cucchiaio moka, mokkalöffel	0/12/120/2520/15120	120	125	1,5
	M9332	MAZO 2 CUCHILLO CHULETERO film 2 steak knife, film 2 couteau steak, film 2 coltello bistecca, film 2 steakmesser	1/0/48/1008/3024	48	225	
	1612	MAZO 2 CUCHILLO MESA ECO film 2 table knife eco, film 2 couteau table eco, film 2 coltello tavola eco, film 2 tafelmesser eco	1/0/48/1008/3024	48	225	
	1607	MAZO 3 CUCHARA MESA film 3 table spoon, film 3 cuillère table, film 3 cucchiaio tavola, film 3 tafellöffel	1/0/48/1200/3600	48	205	1,5
	1608	MAZO 3 TENEDOR MESA film 3 table fork, film 3 fourchette table, film 3 forchetta tavola, film 3 tafelgabel	1/0/48/1200/3600	48	208	2
	1887	MAZO 6 TENEDOR LUNCH film 6 cake fork, film 6 fourchette gâteau, film 6 forchetta dolce, film 6 kuchengabel	1/0/48/1152/4608	48	145	1,5
	1610	MAZO 6 CUCHARA CAFÉ film 6 tea spoon, film 6 cuillère café, film 6 cucchiaio caffè, film 6 kaffeelöffel	1/0/48/1152/4608	48	140	1,5
	1611	MAZO 6 CUCHARA MOKA film 6 coffee/moka spoon, film 6 cuillère moka, film 6 cucchiaio moka, film 6 mokkalöffel	1/0/48/1152/4608	48	125	1,5
	2660	CORBATA 2 CUCHILLO CHULETERO Tie 2 steak knife, cavalier 2 couteau steak, cravatta 2 coltello bistecca, krawatte 2 steakmesser	1/4/48/672/2688	48	225	
	2509	CORBATA 3 CUCHARA MESA Tie 3 table spoon, cavalier 3 cuillère table, cravatta 3 cucchiaio tavola, krawatte 3 takkelöffel	1/4/48/672/2688	48	205	1,5
	2510	CORBATA 3 TENEDOR MESA Tie 3 table fork, cavalier 3 fourchette table, cravatta 3 forchetta tavola, krawatte 3 tafelgabel	1/4/48/672/2688	48	208	2
	1889	CORBATA 6 TENEDOR LUNCH Tie 6 cake fork, cavalier 6 fourchette gâteau, cravatta 6 forchetta dolce, krawatte 6 kuchengabel	1/4/48/672/2688	48	145	1,5
	2513	CORBATA 6 CUCHARA CAFÉ Tie 6 tea spoon, cavalier 6 cuillère café, cravatta 6 cucchiaio caffè, krawatte 6 kaffeelöffel	1/4/48/672/2688	48	140	1,5
	1890	CORBATA 6 CUCHARA MOKA Tie 6 moka spoon, cavalier 6 cuillère moka, cravatta 6 cucchiaio moka, krawatte 6 mokkalöffel	1/4/48/672/2688	48	125	1,5



2515 24 PIEZAS
24 pieces, écrin 24 pièces, bauletto 24 pz, 24 stück

UE 1/0/4
MOQ 4
mm 2



Luna

INOX Nickel Free 18% / 1,8mm / Mirror



A B C D E F



B C D E



A

NEW

INOX
STAINLESS
STEEL
430

	UE	MOQ	▶ mm	✂ mm
A 7142 CUCHILLO MESA table knife, couteau table, coltello tavola, tafelmesser	0/12/120/1920/5760	120	224	
B 7143 CUCHARA MESA table spoon, cuillère table, cucchiaio tavola, tafellöffel	0/12/120/1440/7200	120	193	1,5
C 7144 TENEDOR MESA table fork, fourchette table, forchetta tavola, tafelgabel	0/12/120/1440/7200	120	190	1,8
D 7145 TENEDOR LUNCH cake fork, fourchette gâteau, forchetta dolce, kuchengabel	0/12/120/2520/15120	120	143	1,5
E 7146 CUCHARA CAFÉ tea spoon, cuillère café, cucchiaio caffè, kaffeelöffel	0/12/120/2520/15120	120	140	1,5
F 7147 CUCHARA MOKA coffee/moka spoon, cuillère moka, cucchiaio moka, mokkalöffel	0/12/120/2520/15120	120	120	1,2
7148 MAZO 2 CUCHILLO MESA film 2 knife, film 2 couteau, film 2 coltello, film 2 messer	1/0/48/1008/3024	48	224	
7149 MAZO 3 CUCHARA MESA film 3 table spoon, film 3 cuillère table, film 3 cucchiaio tavola, film 3 tafellöffel	1/0/48/1200/3600	48	193	1,5
7150 MAZO 3 TENEDOR MESA film 3 table fork, film 3 fourchette table, film 3 forchetta tavola, film 3 tafelgabel	1/0/48/1200/3600	48	190	1,8
7151 MAZO 6 TENEDOR LUNCH film 6 cake fork, film 6 fourchette gâteau, film 6 forchetta dolce, film 6 kuchengabel	1/0/48/1152/4608	48	143	1,5
7152 MAZO 6 CUCHARA CAFÉ film 6 tea spoon, film 6 cuillère café, film 6 cucchiaio caffè, film 6 kaffeelöffel	1/0/48/1152/4608	48	140	1,5
7153 MAZO 6 CUCHARA MOKA film 6 coffee/moka spoon, film 6 cuillère moka, film 6 cucchiaio moka, film 6 mokkalöffel	1/0/48/1152/4608	48	120	1,2
7155 CORBATA 2 CUCHILLO MESA Tie 2 table knife, cavalier 2 couteau table, cravatta 2 coltello tavola, krawatte 2 tafelmesser	1/4/48/672/2688	48	224	
7156 CORBATA 3 CUCHARA MESA Tie 3 table spoon, cavalier 3 cuillère table, cravatta 3 cucchiaio tavola, krawatte 3 taffelöffel	1/4/48/672/2688	48	193	1,5
7157 CORBATA 3 TENEDOR MESA Tie 3 table fork, cavalier 3 fourchette table, cravatta 3 forchetta tavola, krawatte 3 tafelgabel	1/4/48/672/2688	48	190	1,8
7158 CORBATA 6 TENEDOR LUNCH Tie 6 cake fork, cavalier 6 fourchette gâteau, cravatta 6 forchetta dolce, krawatte 6 kuchengabel	1/4/48/672/2688	48	143	1,5
7159 CORBATA 6 CUCHARA CAFÉ Tie 6 tea spoon, cavalier 6 cuillère café, cravatta 6 cucchiaio caffè, krawatte 6 kaffeelöffel	1/4/48/672/2688	48	140	1,5
7160 CORBATA 6 CUCHARA MOKA Tie 6 moka spoon, cavalier 6 cuillère moka, cravatta 6 cucchiaio moka, krawatte 6 mokkalöffel	1/4/48/672/2688	48	120	1,2
7154 24 PIEZAS 24 pieces, écrin 24 pièces, bauletto 24 pz., 24 stück	1/0/4	4		1,8



INOX
STAINLESS
STEEL
430

	UE	MOQ	▶ mm	✂ mm
NEW A 12006 CUCHILLO CHULETERO EUROPA europa steak knife, couteau steakeuropa, coltello bistecca europa, steakmesser europa	0/12/120/1920/5760	120	215	
B 5497 CUCHILLO MESA MICRODENTADO table knife, couteau table, coltello tavola, tafelmesser	0/12/120/1920/5760	120	214	2,5
C 6320 CUCHARA MESA EUROPA XL europa XL table spoon, europa XL cuillère table, cucchiaio tavola europa XL, tafellöffel europa XL	0/12/120/1440/7200	120	195	2,5
D 6321 TENEDOR MESA EUROPA XL europa XL table fork, europa XL fourchette table, forchetta tavola europa XL, tafelgabel europa XL	0/12/120/1440/7200	120	195	1,5
E 2686 CUCHARA CAFÉ tea spoon, cuillère café, cucchiaio caffè, kaffeelöffel	0/12/120/2520/15120	120	140	

	UE	MOQ	▶ mm	✂ mm
A	0/12/120/1920/5760	120	215	
B	0/12/120/1920/5760	120	214	2,5
C	0/12/120/1440/7200	120	195	2,5
D	0/12/120/1440/7200	120	195	1,5
E	0/12/120/2520/15120	120	140	



Hotel Extra M

INOX Nickel Free 18% / 2mm / Mirror



Hotel Extra M

INOX Nickel Free 18% / 2mm / Mirror



INOX
STAINLESS
STEEL
430

	UE	MOQ	▶ mm	✕ mm
A 2454 CUCHILLO CHULETERO steak knife, couteau steak, coltello bistecca, steakmesser	0/12/120/1920/5760	120	225	
B 5497 CUCHILLO MESA MICRODENTADO table knife micro, couteau table micro, coltello tavola micro, tafelmesser micro	0/12/120/1920/5760	120	215	
C 0013 CUCHILLO MESA table knife, couteau table, coltello tavola, tafelmesser	0/12/120/1920/5760	120	214	
D 2679 CUCHARA MESA table spoon, cuillère table, cucchiaio tavola, tafellöffel	0/12/120/1440/7200	120	195	2
E 2680 TENEDOR MESA table fork, fourchette table, forchetta tavola, tafelgabel	0/12/120/1440/7200	120	196	2
F 2681 PALA PESCADO fish knife, couteau poisson, coltello pesce, fischmesser	0/12/120/1440/7200	120	190	1,5
G 2682 TENEDOR PESCADO fish fork, fourchette poisson, forchetta pesce, fischgabel	0/12/120/1440/7200	120	180	1,5
H 0018 CUCHILLO POSTRE dessert knife, couteau dessert, coltello frutta, dessertmesser	0/12/120/1920/5760	120	190	
I 2683 CUCHARA POSTRE dessert spoon, cuillère dessert, cucchiaio frutta, dessertlöffel	0/12/120/1440/7200	120	177	1,5
J 2684 TENEDOR POSTRE dessert fork, fourchette dessert, forchetta frutta, dessertgabel	0/12/120/1440/7200	120	180	1,5
K 0021 CUCHILLO LUNCH cake knife, couteau gâteau, coltello dolce, kuchenmesser	0/12/120/1920/5760	120	165	
L 2685 TENEDOR LUNCH cake fork, fourchette gâteau, forchetta dolce, kuchengabel	0/12/120/2520/15120	120	150	1,5
M 2686 CUCHARA CAFÉ tea spoon, cuillère café, cucchiaio caffè, kaffeelöffel	0/12/120/2520/15120	120	140	1,5
N 2687 CUCHARA MOKA coffee/moka spoon, cuillère moka, cucchiaio moka, mokkalöffel	0/12/120/2520/15120	120	110	1,2
O 2688 CUCHARA REFRESCO soda spoon, cuillère mazagran, cucchiaio bibita, longdrinklöffel	0/12/120/1440/7200	120	205	1,5
P 3092 CUCHARA HELADO ice cream spoon, cuillère à glace, cucchiaio gelato, eiscremelöffel	0/12/120/1440/7200	120	132	1,2
Q 2689 CAZO SOPA soup ladle, louche à potage, mestolo, suppenkelle	1/10/50/150/750	10	270	2,6
R 2690 CUCHARA ENSALADA salad spoon, cuillère à servir salade, cucchiaio servire, salatlöffel	1/10/50/800/4000	10	230	2,8
S 2691 TENEDOR ENSALADA salad fork, fourchette à servir salade, forchetta servire, salatgabel	1/10/50/800/4000	10	235	2,6
T 0031 PALA REPOSTERÍA cake server, pelle à tarte, pala torta, tortenheber	1/10/50/600/2400	10	240	2,5
U 5517 CAZO SALSA sauce ladle, cuillère à sauce, mestolino salsa, soßenkelle	1/10/50/800/4000	10	170	2,5



INOX
STAINLESS
STEEL
430

M5206 MAZO 2 CUCHILLO MESA film 2 knife, film 2 couteau, film 2 coltello, film 2 messer	1/0/48/1008/3024	48	215	
M5202 MAZO 3 CUCHARA MESA film 3 table spoon, film 3 cuillère table, film 3 cucchiaio tavola, film 3 tafellöffel	1/0/48/1200/3600	48	195	1,5
M5203 MAZO 3 TENEDOR MESA film 3 table fork, film 3 fourchette table, film 3 forchetta tavola, film 3 tafelgabel	1/0/48/1200/3600	48	196	2
M3036 MAZO 6 TENEDOR LUNCH film 6 cake fork, film 6 fourchette gâteau, film 6 forchetta dolce, film 6 kuchen-gabel	1/0/48/1152/4608	48	150	1,5
M3037 MAZO 6 CUCHARA CAFÉ film 6 tea spoon, film 6 cuillère café, film 6 cucchiaio caffè, film 6 kaffeelöffel	1/0/48/1152/4608	48	140	1,5
M3038 MAZO 6 CUCHARA MOKA film 6 coffee/moka spoon, film 6 cuillère moka, film 6 cucchiaio moka, film 6 mokkalöffe	1/0/48/1152/4608	48	110	1,2

	UE	MOQ	▶ mm	✕ mm
	1/0/48/1008/3024	48	215	
	1/0/48/1200/3600	48	195	1,5
	1/0/48/1200/3600	48	196	2
	1/0/48/1152/4608	48	150	1,5
	1/0/48/1152/4608	48	140	1,5
	1/0/48/1152/4608	48	110	1,2



Hotel Extra Eco

INOX Nickel Free 18% / 1,5mm / Mirror

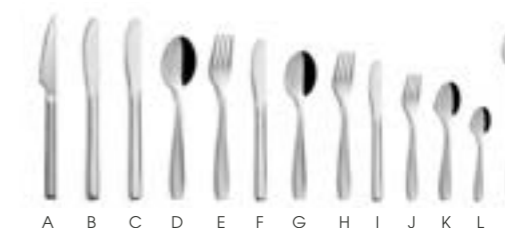
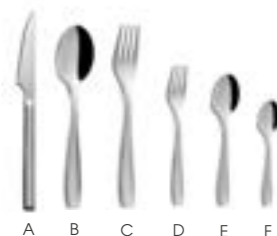

Hotel

INOX Nickel Free 18% / 1,5mm / Vibrado

INOX STAINLESS STEEL 430

	UE	MOQ	▶ mm	✂ mm
A 2454 CUCHILLO CHULETERO steak knife, couteau steak, coltello bistecca, steakmesser	0/12/120/1920/5760	120	225	
B 8009 CUCHARA MESA ECO table spoon eco, cuillère table eco, cucchiaio tavola eco, tafellöffel eco	0/12/120/1440/7200	120	195	1,5
C 8010 TENEDOR MESA ECO table fork eco, fourchette table eco, forchetta tavola eco, tafelgabel eco	0/12/120/1440/7200	120	196	1,5
D 0940 TENEDOR LUNCH ECO cake fork eco, fourchette gâteau eco, forchetta dolce eco, kuchengabel eco	0/12/120/2520/15120	120	150	1,2
E 0941 CUCHARA CAFÉ ECO tea spoon eco, cuillère café eco, cucchiaio caffè eco, kaffeelöffel eco	0/12/120/2520/15120	120	140	1,2
F 0942 CUCHARA MOKA ECO coffee/moka spoon eco, cuillère moka eco, cucchiaio moka eco, mokkalöffel eco	0/12/120/2520/15120	120	110	1
5206 CORBATA 2 CUCHILLO MESA MICRO Tie 2 steak knife micro, cavalier 2 couteau steak micro, cravatta 2 coltello bistecca micro, krawatte 2 steakmesser micro	1/4/48/672/2688	48	215	
5202 CORBATA 3 CUCHARA MESA Tie 3 table spoon, cavalier 3 cuillère table, cravatta 3 cucchiaio tavola, krawatte 3 takkelöffel	1/4/48/672/2688	48	195	1,5
5203 CORBATA 3 TENEDOR MESA Tie 3 table fork, cavalier 3 fourchette table, cravatta 3 forchetta tavola, krawatte 3 tafelgabel	1/4/48/672/2688	48	196	1,5
3036 CORBATA 6 TENEDOR LUNCH Tie 6 cake fork, cavalier 6 fourchette gâteau, cravatta 6 forchetta dolce, krawatte 6 kuchengabel	1/4/48/672/2688	48	150	1,5
3037 CORBATA 6 CUCHARA CAFÉ Tie 6 tea spoon, cavalier 6 cuillère café, cravatta 6 cucchiaio caffè, krawatte 6 kaffeelöffel	1/4/48/672/2688	48	140	1,5
3038 CORBATA 6 CUCHARA MOKA Tie 6 moka spoon, cavalier 6 cuillère moka, cravatta 6 cucchiaio moka, krawatte 6 mokkalöffel	1/4/48/672/2688	48	110	1,2

INOX STAINLESS STEEL 430

	UE	MOQ	▶ mm	✂ mm
A 2454 CUCHILLO CHULETERO steak knife, couteau steak, coltello bistecca, steakmesser	0/12/120/1920/5760	120	225	
B 5497 CUCHILLO MESA MICRODENTADO table knife micro, couteau table micro, coltello tavola micro, tafelmesser micro	0/12/120/1920/5760	120	215	
C 0013 CUCHILLO MESA table knife, couteau table, coltello tavola, tafelmesser	0/12/120/1920/5760	120	214	
D 0014 CUCHARA MESA table spoon, cuillère table, cucchiaio tavola, tafellöffel	0/12/120/1440/7200	120	195	1,5
E 0015 TENEDOR MESA table fork, fourchette table, forchetta tavola, tafelgabel	0/12/120/1440/7200	120	197	1,5
F 0018 CUCHILLO POSTRE dessert knife, couteau dessert, coltello frutta, dessertmesser	0/12/120/1920/5760	120	190	
G 0019 CUCHARA POSTRE dessert spoon, cuillère dessert, cucchiaio frutta, dessertlöffel	0/12/120/1440/7200	120	177	1,5
H 0020 TENEDOR POSTRE dessert fork, fourchette dessert, forchetta frutta, dessertgabel	0/12/120/1440/7200	120	178	1,5
I 0021 CUCHILLO LUNCH cake knife, couteau gâteau, coltello dolce, kuchenmesser	0/12/120/1920/5760	120	165	
J 0022 TENEDOR LUNCH cake fork, fourchette gâteau, forchetta dolce, kuchengabel	0/12/120/2520/15120	120	150	1,2
K 0023 CUCHARA CAFÉ tea spoon, cuillère café, cucchiaio caffè, kaffeelöffel	0/12/120/2520/15120	120	140	1,2
L 0024 CUCHARA MOKA coffee/moka spoon, cuillère moka, cucchiaio moka, mokkalöffel	0/12/120/2520/15120	120	110	1
M 0033 CUCHARA REFRESCO soda spoon, cuillère mazagan, cucchiaio bibita, longdrinklöffel	0/12/120/1440/72008	120	205	1,5

Brooklyn

INOX Nickel Free 18% / 0,6mm / Vibrado



INOX STAINLESS STEEL 430



* Bolsa con apertura lateral. Side-opening bag



* Bolsa con apertura lateral. Side-opening bag



INOX STAINLESS STEEL 430

- A **8334** CUCHILLO MESA
table knife, couteau table, coltello tavola, tafelmesser
- B **8335** CUCHARA MESA
table spoon, cuillère table, cucchiaio tavola, tafellöffel
- C **8336** TENEDOR MESA
table fork, fourchette table, forchetta tavola, tafelgabel
- D **8337** CUCHARA CAFÉ
tea spoon, cuillère café, cucchiaio caffè, kaffeelöffel
- 8338** KIT 4 PCS CUCHILLO, TENEDOR, CUCHARA Y SERVILLETA
set table knife/fork/spoon + napkin
set couteau table/cuillère table/fourchette table + serviette
set coltello tavola/cucchiaio tavola /forchetta tavola + tovagliolo
set tafelmesser/tafellöffel/tafelgabel + serviette
- 5254** KIT CUCHARA HELADO Y SERVILLETA
set ice cream spoon + napkin
set cuillère café + serviette
set cucchiaio caffè + tovagliolo
set kaffeelöffel + serviette
- 8184** KIT 4 PCS CUCHILLO, TENEDOR, CUCHARA CAFÉ Y SERVILLETA
set table knife/fork/tea spoon + napkin
set couteau table/cuillère café/fourchette table + serviette
set coltello tavola/cucchiaio caffè /forchetta tavola + tovagliolo
set tafelmesser/kaffeelöffel/tafelgabel + serviette

UE	MOQ	✂ mm	✂ mm
0/12/360/7200/14400	360	185	0,6
0/12/360/7200/14400	360	170	0,6
0/12/360/7200/14400	360	170	0,6
0/12/600/7200/36000	600	120	0,6
1/0/120/0/0	120		0,6



PP
POLYPROPYLENE

Take Away



* Los cubiertos no van incluidos
Cutlery is not included

8373 CAJA POLIPROPILENO
pp case, boîte pp, scatola pp, box pp

UE	MOQ	Lmm	Wmm
1-0-120-480-960 / 6	6	235	32



INOX STAINLESS STEEL 430

	UE	MOQ	▶ mm	✂ mm
A 1489 CUCHILLO MESA table knife, couteau table, coltello tavola, tafelmesser	0/12/120/1920/5760	120	210	
B 0001 CUCHARA MESA table spoon, cuillère table, cucchiaio tavola, tafellöffel	0/12/360/7200/14400	360	200	1,5
C 0002 TENEDOR MESA table fork, fourchette table, forchetta tavola, tafelgabel	0/12/360/7200/14400	360	200	1,5
D 0009 CUCHILLO POSTRE dessert knife, couteau dessert, coltello frutta, dessertmesser	0/12/120/1920/5760	120	190	
E 0003 CUCHARA CADETE dessert spoon, cuillère dessert, cucchiaio frutta, dessertlöffel	0/12/360/8640/17280	360	185	1,2
F 0004 TENEDOR CADETE dessert fork, fourchette dessert, forchetta frutta, dessertgabel	0/12/360/10800/21600	360	185	1,2
G 0005 TENEDOR LUNCH cake fork, fourchette gâteau, forchetta dolce, kuchengabel	0/12/600/16800/50400	600	140	1,2
H 4504 TENEDOR MINI LUNCH mini cake fork, fourchette minigâteau, forchetta mini dolce, kuchengabel klein	0/12/600/25200/75600	600	110	1
I 1664 CUCHARA CAFÉ REFORZADA tea spoon reinf., cuillère café renforcé, cucchiaio caffè rforzatta, kaffeelöffel verstärkt	0/12/600/12000/36000	600	140	1,2
J 0006 CUCHARA CAFÉ tea spoon, cuillère café, cucchiaio caffè, kaffeelöffel	0/12/600/12000/36000	600	140	1
K 2731 CUCHARA CAFÉ ECO tea spoon eco, cuillère café eco, cucchiaio caffè eco, kaffeelöffel eco	0/12/600/12000/36000	600	140	1
L 0007 CUCHARA MOKA coffee/moka spoon, cuillère moka, cucchiaio moka, mokkalöffel	0/12/600/25200/75600	600	110	1
2459 2 CUCHARA MESA 2 table spoon, 2 cuillère table, 2 cucchiaio tavola, 2 tafellöffel	2/18/270/5400/10800	270	185	1,2
2460 2 TENEDOR MESA 2 table fork, 2 fourchette table, 2 forchetta tavola, 2 tafelgabel	2/18/270/5400/10800	270	185	1,2
2461 4 TENEDOR PASTEL 4 cake fork, 4 fourchette gâteau, 4 forchetta dolce, 4 kuchengabel	2/18/270/5400/10800	270	140	1,2
2462 4 CUCHARA CAFÉ 4 tea spoon, 4 cuillère café, 4 cucchiaio caffè, 4 kaffeelöffel	2/18/270/5400/10800	270	140	1
2463 4 CUCHARA MOKA 4 coffee/moka spoon, 4 cuillère moka, 4 cucchiaio moka, 4 mokkalöffel	4/18/270/6750/13500	270	110	1



INOX STAINLESS STEEL 430

	UE	MOQ	▶ mm	✂ mm
A 0481 CUCHILLO MESA table knife, couteau table, coltello tavola, tafelmesser	0/12/240/6000/18000	240	220	2,5
B 3185 CUCHARA MESA table spoon, cuillère table, cucchiaio tavola, tafellöffel	0/12/360/7200/14400	360	200	1,5
C 3186 TENEDOR MESA table fork, fourchette table, forchetta tavola, tafelgabel	0/12/360/10440/20880	360	200	1,5
D 3187 CUCHARA POSTRE dessert spoon, cuillère dessert, cucchiaio frutta, dessertlöffel	0/12/360/10800/21600	360	170	1,5
H 3188 TENEDOR POSTRE dessert fork, fourchette dessert, forchetta frutta, dessertgabel	0/12/360/10800/21600	360	170	1,5
F 3189 TENEDOR LUNCH cake fork, fourchette gâteau, forchetta dolce, kuchengabel	0/12/600/16800/50400	600	133	1,2
G 3190 CUCHARA CAFÉ tea spoon, cuillère café, cucchiaio caffè, kaffeelöffel	0/12/600/12000/36000	600	133	1,2
H 3191 CUCHARA MOKA coffee/moka spoon, cuillère moka, cucchiaio moka, mokkalöffel	0/12/600/25200/75600	600	110	1
4571 2 CUCHILLO MESA ECO 2 table knife eco, 2 couteau table eco, 2 coltello tavola eco, 2 tafelmesser eco	0/18/270/3240/6480	270	220	
3192 3 CUCHARA MESA 3 table spoon, 3 cuillère table, 3 cucchiaio tavola, 3 tafellöffel	0/12/180/2700/5400	180	170	1,5
3193 3 TENEDOR MESA 3 table fork, 3 fourchette table, 3 forchetta tavola, 3 tafelgabel	0/12/180/3600/7200	180	170	1,5
3194 6 TENEDOR PASTEL 6 cake fork, 6 fourchette gâteau, 6 forchetta dolce, 6 kuchengabel	0/12/180/3600/7200	180	133	1,2
3195 6 CUCHARA CAFÉ 6 tea spoon, 6 cuillère café, 6 cucchiaio caffè, 6 kaffeelöffel	0/12/180/3600/7200	180	133	1,2
3196 6 CUCHARA MOKA 6 coffee/moka spoon, 6 cuillère moka, 6 cucchiaio moka, 6 mokkalöffel	0/12/180/3600/10800	180	110	1



1003

INOX Nickel Free 18% / 1,2mm / Vibrado



INOX STAINLESS STEEL 430

	UE	MOQ	▶ mm	✂ mm
A 3618 CUCHILLO MESA table knife, couteau table, coltello tavola, tafelmesser	0/12/120/1920/5760	120	224	
B 3548 3 CUCHARA MESA 3 table spoon, 3 cuillère table, 3 cucchiaino tavola, 3 tafellöffel	3/12/180/3600/7200	180	185	1,2
C 3549 3 TENEDOR MESA 3 table fork, 3 fourchette table, 3 forchetta tavola, 3 tafelgabel	3/12/180/3600/7200	180	185	1,2
D 3550 6 TENEDOR PASTEL 6 cake fork, 6 fourchette gâteau, 6 forchetta dolce, 6 kuchengabel	6/12/180/3600/7200	180	140	1
E 3551 6 CUCHARA CAFÉ 6 tea spoon, 6 cuillère café, 6 cucchiaino caffè, 6 kaffeelöffel	6/12/180/3600/7200	180	140	1
F 3552 6 CUCHARA MOKA 6 coffee/moka spoon, 6 cuillère moka, 6 cucchiaino moka, 6 mokkalöffel	6/12/180/4500/9600	180	110	1

Nervio

INOX Nickel Free 18% / 1,2mm / Vibrado



INOX STAINLESS STEEL 430

	UE	MOQ	▶ mm	✂ mm
A 0278 3 CUCHARA MESA 3 table spoon, 3 cuillère table, 3 cucchiaino tavola, 3 tafellöffel	3/12/180/3600/7200	180	185	1,2
B 0279 3 TENEDOR MESA 3 table fork, 3 fourchette table, 3 forchetta tavola, 3 tafelgabel	3/12/180/3600/7200	180	185	1,2
C 0280 6 TENEDOR PASTEL 6 cake fork, 6 fourchette gâteau, 6 forchetta dolce, 6 kuchengabel	6/12/180/3600/7200	180	140	1,2
D 0281 6 CUCHARA CAFÉ 6 tea spoon, 6 cuillère café, 6 cucchiaino caffè, 6 kaffeelöffel	6/12/180/3600/7200	180	140	1
E 0282 6 CUCHARA MOKA 6 coffee/moka spoon, 6 cuillère moka, 6 cucchiaino moka, 6 mokkalöffel	6/12/180/4500/9000	180	110	1

UE	MOQ	▶ mm	✂ mm
3/12/180/3600/7200	180	185	1,2
3/12/180/3600/7200	180	185	1,2
6/12/180/3600/7200	180	140	1,2
6/12/180/3600/7200	180	140	1
6/12/180/4500/9000	180	110	1



INOX STAINLESS STEEL 430

	UE	MOQ	▶ mm	✂ mm
A 6338 6 CUCHARA CAFÉ 6 tea spoon, 6 cuillère café, 6 cucchiaino caffè, 6 kaffeelöffel	0/60/600/16800/50400	600	120	1
B 6339 6 CUCHARA MOKA 6 coffee/moka spoon, 6 cuillère moka, 6 cucchiaino moka, 6 mokkalöffel	0/60/600/25200/75600	600	102	1

UE	MOQ	▶ mm	✂ mm
0/60/600/16800/50400	600	120	1
0/60/600/25200/75600	600	102	1



INOX STAINLESS STEEL 430

	UE	MOQ	▶ mm	✂ mm
5651 CORBATA 6 CUCHARA APERITIVO 6 aperitive spoon, 6 aperitive cuillère, 6 aperitive spoon, 6 aperitive spoon	1/4/48/720/3600	48	108	1,5

UE	MOQ	▶ mm	✂ mm
1/4/48/720/3600	48	108	1,5



INOX STAINLESS STEEL 430

	UE	MOQ	▶ mm	✂ mm
0669 CUCHARA DEGUSTACIÓN PELLE pelle aperitive spoon, cuillère degustation pelle, cucchiaino degustazione, pelle aperitivlöffel	0/12/120/9600/38400	120	123	1,3

UE	MOQ	▶ mm	✂ mm
0/12/120/9600/38400	120	123	1,3

Arabica

INOX Nickel Free 18% / 1mm / Vibrado

UE	MOQ	▶ mm	✂ mm
0/60/600/16800/50400	600	120	1
0/60/600/25200/75600	600	102	1

UE	MOQ	▶ mm	✂ mm
1/4/48/720/3600	48	108	1,5

UE	MOQ	▶ mm	✂ mm
0/12/120/9600/38400	120	123	1,3

CHULETEROS

STEAK KNIVES



CHULETEROS

STEAK KNIVES

- 178 KAJI
- 182 MEZZA
- 184 EVEREST
- 186 OLIU
- 188 SILEX
- 190 MAGNOLIA
- 192 HQ: 5Cr15Mov
- 194 HQ
- 204 UTSET + COMAS
- 208 INOX
- 209 NAPOLI PIZZA
- 210 ECO

Diseño moderno con alma de tradición japonesa.
Modern design with Japanese tradition.



Inspirado en los cuchillos japoneses Kiritsuke, Kaji es una pieza de diseño único. Su hoja con acabado damasco revela el saber hacer artesanal con líneas ligeramente curvadas para un corte preciso. El mango, de madera maciza con un toque de color, reinterpreta los mangos octogonales tradicionales para la mesa moderna, ofreciendo ergonomía y equilibrio perfectos.

Le acompaña un tenedor con dos puntas y mango simétrico, completando un conjunto icónico y exclusivo. El Nombre Kaji significa "forja" o "fuego" en japonés, refleja el proceso meticuloso de creación de esta pieza única.

Inspired by the Japanese Kiritsuke knives, Kaji is a unique piece of design. Its damask-finished blade reveals the craftsman's know-how with slightly curved lines for a precise cut. The handle, solid wood with a touch of colour, reinterprets traditional octagonal handles for the modern table, offering perfect ergonomics and balance.

It is accompanied by a fork with two prongs and a symmetrical handle, completing an iconic and exclusive set. The name Kaji means 'forge' or 'fire' in Japanese, reflecting the meticulous process of creating this unique piece.

Proyecto diseñado por:
Project designed by:

Bahigüell

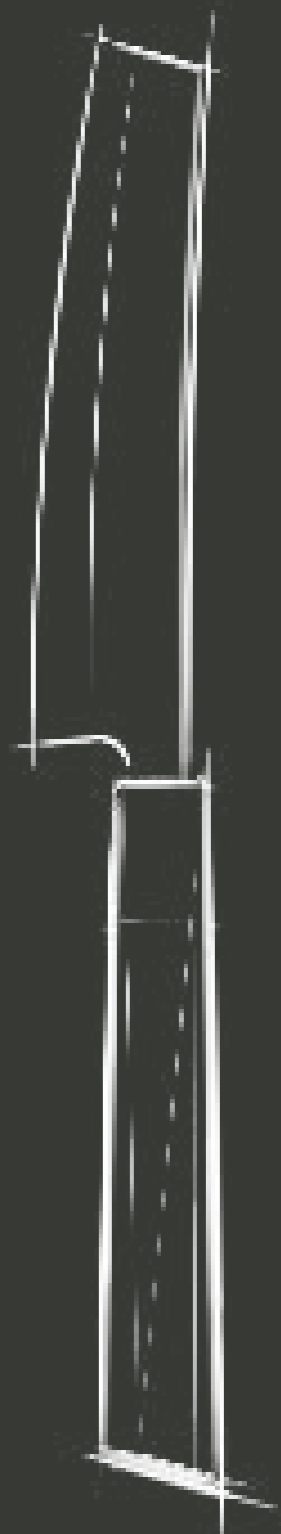

Proyecto diseñado por:
Project designed by:

Bahigüell

INOX 18/10 / Mirror & Satin



Recomendado lavar a mano
Hand washing recommended



33 CAPAS ACERO 316L
33 LAYERS 316L STEEL

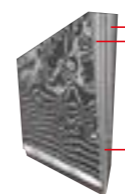

NÚCLEO ACERO VG1
VG10 STEEL CORE



D



A



B



C



SATIN

DAMASCUS 67 LAYERS / VG10 STEEL CORE



A



B



C

	UE	MOQ	mm	mm
A 10997 CUCHILLO CHULETERO KAJI kaji steak knife, couteau steak kaji, coltello bistecca kaji, steakmesser kaji	1/6/30	6	232	
B 11942 TENEDOR CHULETERO KAJI MIRROR kaji steak fork, fourchette steak kaji, forchetta bistecca kaji, steakgabel kaji	0/6/60	60	210	6
C 12000 TENEDOR CHULETERO KAJI SATIN kaji steak fork, fourchette steak kaji, forchetta bistecca kaji, steakgabel kaji	0/6/60	60	210	6
D 12001 ESTUCHE CON CUCHILLO Y TENEDOR KAJI kaji steak knife and fork case, étui à couteau steak et fourchette kaji, astuccio per coltello e forchetta kaji, kaji steakmesser und gabel etui	1/6/36	6		

Mezza

NEW



Proyecto diseñado por:
Project designed by:

Shu Hon Leung Andy

Mezza

INOX 18/10 / Bimaterial



Recomendado lavar a mano
Hand washing recommended



MIKARTA:

Material compuesto hecho a base de capas de tejidos, impregnadas con resina y prensadas. Curadas bajo alta presión y temperatura.

Composite material made of layers of fabrics, impregnated with resin and pressed. Cured under high pressure and temperature.



A B

FRONTAL INOX



REVERSO MIKARTA

MEZZA es mucho más que un juego de mesa para carne. Fusiona tradición, diseño moderno y artesanía impecable. En la cultura gastronómica italiana, Mezza se utiliza a menudo para describir una pequeña porción de aperitivos o bebidas. Representa una experiencia gastronómica relajada y agradable, que permite disfrutar de deliciosa comida y pasar un buen rato con la familia y los amigos.

MEZZA is much more than a meat table set. Fusion of tradition, modern design and impeccable craftsmanship. In Italian dining culture, Mezza is often used to describe a small portion of appetizers or drinks. It represents a relaxed and enjoyable dining experience, allowing you to enjoy delicious food and have a good time with family and friends.

INOX 18/10/ BIMATERIAL



A B

182

INOX
STAINLESS
STEEL
304

- A **12017** CUCHILLO CHULETERO MEZZA
mezza steak knife, couteau steak mezza, coltello bistecca mezza, steakmesser mezza
- B **12018** TENEDOR CHULETERO MEZZA
mezza steak fork, fourchette steak mezza, forchetta bistecca mezza, steakgabel mezza
- 12019** CAJA PRESENTACIÓN CON 2 CUCHILLOS Y 2 TENEDORES MEZZA
box with 2 mezza knives and 2 forks, boîte avec 2 couteaux et 2 fourchettes mezza, scatola con 2 coltelli e 2 forchette mezza, box mit 2 mezzamessen und 2 gaben

UE	MOQ	✂ mm	✂ mm
0/6/60	60	237	4
0/6/60	60	210	3,5
1/0/12	12		

183



Proyecto diseñado por:
Project designed by:

Pablo Castillo

INOX 18/10 / Mirror & Polvo de Luna

Everest surge como un conjunto bipieza de inspiración japonesa pero que a su vez combina en armonía con nuestra colección Atlántida para complementarla y ofrecer una opción más para los platos de carne.

Everest is a Japanese-inspired two-piece set that combines with harmony with our Atlántida collection to complement it and offer another option for meat dishes.



INOX 18/10 / Mirror & Satin

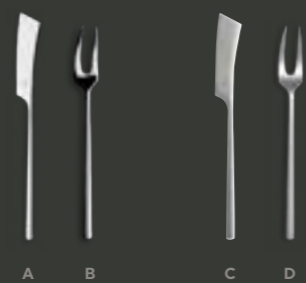

- | | | |
|---|--------------|---|
| A | 11582 | CUCHILLO CHULETERO EVEREST MIRROR
steak knife, couteau steak , coltello bistecca , steakmesser |
| B | 11583 | TENEDOR CHULETERO EVEREST MIRROR
steak fork, fourchette steak , forchetta bistecca, steakgabel |
| C | 10988 | CUCHILLO CHULETERO EVEREST P. DE LUNA
steak knife, couteau steak , coltello bistecca , steakmesser |
| D | 10989 | TENEDOR CHULETERO EVEREST P. DE LUNA
steak fork, fourchette steak , forchetta bistecca, steakgabel |

UE	MOQ	mm	mm
0/6/60/540/2160	60	220	
0/6/60/540/2160	60	206	
0/6/60/540/2160	60	220	
0/6/60/540/2160	60	206	



Proyecto
OLIU.

Proyecto diseñado por:
Project designed by:

Silvia Rodríguez Petit
Liam Kelly Ortiz
Erik Obermüller Vilor
Albert Sadurní Roca

ELISAVA Escuela Universitaria de Barcelona Diseño e Ingeniería

Uno de los proyectos troncales que se desarrollaron en la 18a edición del Master en Diseño y Desarrollo de Producto, fue el proyecto que Comas propuso a los alumnos del Master. El reto consistió en diseñar y desarrollar un cuchillo icónico que pudiera complementar algunas de las colecciones actuales de nuestro catálogo.

Los 26 alumnos del Master, repartidos en 5 grupos, en la 1a fase conceptual presentaron 26 propuestas de diseño de nuevos cuchillos, de los cuales desarrollaron 12 propuestas con todo detalle y llegaron a un prototipo volumétrico de calidad, siguiendo las indicaciones de la empresa.

One of the core projects developed in the 18th edition of the Master's Degree in Product Design and Development was the project that Comas proposed to the Master's students. The challenge consisted of designing and developing an iconic knife that could complement some of the current collections in our catalogue.

The 26 Master's students, divided into 5 groups, presented 26 design proposals for new knives in the 1st conceptual phase, of which they developed 12 proposals in detail and reached a quality volumetric prototype, following the indications of the company.



INOX 18/10 / Mirror



10994 CUCHILLO CHULETERO OLIU
oliu steak knife, couteau steak oliu, Coltello bistecca oliu, oliu steakmesser

UE	MOQ	mm
0/6/60/540/2160	60	226

Proyecto en colaboración con:



INOX 18/10 / Satin



A B



INOX
STAINLESS
STEEL
420



INOX
STAINLESS
STEEL
304



BAMBOO
WOOD

	UE	MOQ	mm	mm
A 6318 CUCHILLO CHULETERO SILEX silex steak knife, couteau steak silex, coltello bistecca silex, steakmesser silex	1/0/20/130/390	20	185	
B 6319 TENEDOR CHULETERO SILEX silex steak fork, fourchette steak silex, forchetta bistecca silex, steakgabel silex	1/0/20/130/390	20	185	
6322 CUCHILLO + TENEDOR SILEX silex knife + fork, couteau + fourchette silex, coltello + forchetta silex, silex messer + gabel	1/0/8/72/216	8		



Magnolia

Proyecto diseñado por:
Project designed by:

Lúcid Design Agency



INOX 18/10 / 9mm / PVD Negro / Mirror



A B

190

Proyecto diseñado por:
Project designed by:

Lúcid Design Agency



reddot design award
winner 2018

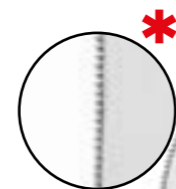

INOX
STAINLESS
STEEL
420



INOX
STAINLESS
STEEL
304



* Compatible con:
5207 / 5208

UE

MOQ

mm

mm

- A **6445** CUCHILLO CHULETERO K9 MAGNOLIA SIERRA
k9 magnolia steak knife, couteau steak k9 magnolia saw, coltello bistecca sega k9
magnolia scie, steakmesser k9 magnolia säge
- B **6446** TENEDOR CHULETERO K9 MAGNOLIA
k9 magnolia steak fork, fourchette steak k9 magnolia, forchetta bistecca k9
magnolia, steakgabel k9 magnolia

0/6/60/720/3600

6

226

0/6/60/720/3600

6

203

9



191

5CR15Mov

Acero de gran dureza
High hardness steel



¿Eres un amante de la carne? Si es así, deberías utilizar cuchillos con un acero de gran calidad y un buen afilado para que el corte de la carne sea fácil y limpio. Y es que con un buen cuchillo se puede disfrutar al máximo de un delicioso trozo de carne.

Are you a meat lover? If so, you should use knives with high quality steel and a good sharpening to make cutting meat easy and clean. With a good knife, you can enjoy a delicious piece of meat to the full.

ACERO DE GRAN DUREZA
HIGH HARDNESS STEEL



CUCHILLO CHULETERO ANETO MIKARTA



* Caja 6 chuleteros.



* Compatible con estuches acacia: 5207 / 5208

	UE	MOQ	mm
A 8508 CUCHILLO CHULETERO ANETO MIKARTA aneto mikarta steak knife, couteau steak aneto mikarta, coltello bistecca aneto mikarta, steakmesser aneto mikarta	0/6/60/720/2880	60	223
B 7532 CUCHILLO CHULETERO ANETO aneto steak knife, couteau steak aneto, coltello bistecca aneto, steakmesser aneto	0/6/60/720/2880	60	223
C 3013 CHULETERO ALPS FILO alps filo steak knife, couteau steak alps filo, coltello bistecca alps filo, steakmesser alps filo	0/6/60/720/3600	60	230
* 6887 6 PCS MADERA ALPS FILO alps filo steak knife 6 pieces wood, écrin bois 6 couteaux alps filo, 6 pz legno alps filo, 6- teilige holz-untersetzer alps filo	1/6/78/234	6	230
D 7068 CUCHILLO CHULETERO MONTBLANC montblanc steak knife, couteau steak montblanc, coltello bistecca montblanc, steakmesser montblanc	6/60/720/3600	60	230
* 5285 6 PCS MADERA MONTBLANC montblanc steak knife 6 pieces wood, écrin bois 6 couteaux montblanc, 6 pz legno montblanc, 6- teilige holz-untersetzer montblanc	1/6/78/234	6	230
E 8595 CUCHILLO CHULETERO MONTBLANC NEGRO montblanc black steak knife, couteau steak montblanc black, coltello bistecca montblanc black, steak messer montblanc black	6/60/720/3600	60	230
F 10972 CUCHILLO ABREOSTRAS oyster knife, couteau à huîtres, aprostriche, austernmesser	0/6/60/540/2160	60	160



HQ: 5Cr15Mov

El acero 5CR15Mov tiene una baja porción de carbono lo que lo hace un material de gran dureza, por lo que el filo conserva más tiempo la capacidad de corte.

Además, ofrece una gran resistencia a la corrosión con más del 15% de cromo.

5CR15Mov steel has a low carbon content which makes it a very hard material, so the cutting edge retains its cutting ability for a longer period of time.

In addition, it offers high corrosion resistance with more than 15% chromium.

ALTA DUREZA
HIGH HARDNESS 5Cr15Mov





CUCHILLO CHULETERO ALPS



* Caja 6 chuleteros.



* Compatible con estuches acacia: 5207 / 5208

	UE	MOQ	mm
A 10971 CUCHILLO CHULETERO DENALI denali steak knife, couteau steak denali, coltello bistecca denali, denali steakmesser	0/6/60/540/2160	60	225
B 3000 CHULETERO ALPS alps steak knife, couteau steak alps, coltello bistecca alps, steakmesser alps	0/6/60/720/3600	60	230
* 5286 6 PCS MADERA ALPS alps steak knife 6 pieces wood, écrin bois 6 couteaux alps, 6 pz legno alps, 6-teilige holz-untersetzer alps	1/6/78/234	6	230
C 6162 TENEDOR CHULETERO ALPS alps steak fork, fourchette steak alps, forchetta bistecca alps, steakgabel alps	0/6/60/720/3600	60	227
* 6334 6 PCS MADERA TENEDOR ALPS alps fork 6 pieces wood, écrin 6 pièces fourchette alps, bauletto in legno 6 pz. forchetta alps, gabel 6 stück holz alps	1/6/78/234	6	227
D 10973 CUCHILLO CHULETERO MINI ALPS alps mini steak knife, couteau steak alps mini, coltello bistecca alps mini, steakmesser alps mini	0/6/60/540/2160	60	190
E 10974 TENEDOR CHULETERO MINI ALPS alps mini steak fork, fourchette steak alps mini, forchetta bistecca alps mini, steakgabel alps mini	0/6/60/540/2160	60	175
F 3001 CHULETERO NICOLAS nicolas steak knife, couteau steak nicolas, coltello bistecca nicolas, steakmesser nicolas	0/6/60/720/3600	60	230
* 5280 6 PCS MADERA NICOLAS nicolas 6 pieces wood, écrin 6 pièces nicolas, bauletto in legno 6 pz. nicolas,	1/6/78/234	6	230
G 3137 CHULETERO K2 NEGRO k2 black steak knife, couteau steak k2 noir, coltello bistecca k2 nero, steakmesser k2 schwarz	0/6/60/720/3600	60	225
* 5278 6 PCS MADERA K2 NEGRO k2 black 6 pieces wood, écrin 6 pièces k2 noir, bauletto in legno 6 pz. k2 nero, k2 schwarz 6 stück holz	1/6/78/234	6	225
H 3136 CHULETERO K2 k2 steak knife, couteau steak k2, coltello bistecca k2, steakmesser k2	0/6/60/720/3600	60	225
* 5287 6 PCS MADERA K2 k2 6 pieces wood, écrin 6 pièces k2, bauletto in legno 6 pz. k2, k2 6 stück holz	1/6/78/234	6	225





CUCHILLO CHULETERO K6 - BOJ SATIN GOLD



* Caja 6 chuleteros.



NEW

A

B

C

D

E

F

G

H

I

J

NEW

- A **12006** CUCHILLO CHULETERO EUROPA
europa steak knife, couteau steakeuropa, coltello bistecca europa, steakmesser europa
- B **11584** CUCHILLO CHULETERO SANTORINI
santorini steak knife, couteau steak santorini, coltello bistecca santorini, steakmesser santorini
- C **6161** CUCHILLO CHULETERO GEOMETRIC
geometric steak knife, couteau steak geometric, coltello bistecca geometric, steakmesser geometric
- * **6333** 6 PCS MADERA GEOMETRIC
geometric 6 pieces wood, écrin 6 pièces geometric, bauletto in legno 6 pz. geometric, geometric 6 stück holz
- D **3107** CUCHILLO CHULETERO SUTIL
sutil steak knife, couteau steak sutil, coltello bistecca sutil, sutil steakmesser
- * **5277** 6 PCS MADERA SUTIL
sutil 6 pieces wood, écrin 6 pièces sutil, bauletto in legno 6 pz. sutil, sutil 6 stück holz
- E **2818** CUCHILLO CHULETERO RAMBO
rambo steak knife, couteau steak rambo, coltello bistecca rambo, rambo steakmesser
- * **5288** 6 PCS MADERA RAMBO
rambo 6 pieces wood, écrin 6 pièces rambo, bauletto in legno 6 pz. rambo, rambo 6 stück holz
- F **2999** CUCHILLO CHULETERO K6 BOJ SATIN
k6 boj satin steak knife, couteau steak k6 boj satin, coltello bistecca k6 boj satin, steakmesser k6 boj satin
- G **6013** CUCHILLO CHULETERO K6.2 BOJ
k6.2 boj steak knife, couteau steak k6.2 boj, coltello bistecca k6.2 boj satin, steakmesser k6.2 boj
- H **7432** CUCHILLO CHULETERO K6 BOJ SATIN GOLD
boj satin/k6 steak knife gold, couteau steak boj satin/k6 gold, coltello bistecca boj satin/k6 gold, steakmesser boj satin/k6 gold
- I **7433** CUCHILLO CHULETERO K6 BOJ SATIN GUNMETAL
boj satin/k6 steak knife gunmetal, couteau steak boj satin/k6 gunmetal, coltello bistecca boj satin/k6 gunmetal, steakmesser boj satin/k6 gunmetal
- J **7431** CUCHILLO CHULETERO K6 BOJ SATIN COPPER
boj satin/k6 steak knife copper, couteau steak boj satin/k6 copper, coltello bistecca boj satin/k6 copper, steakmesser boj satin/k6 copper

UE	MOQ	mm
0/6/60/720/3600	60	215
1/12/120/1920/5760	120	235
0/6/60/720/3600	60	232
0/6/60/720/3600	6	232
0/6/60/720/3600	60	232
0/6/60/720/3600	6	232
0/6/60/720/2880	60	225
0/6/60/720/2880	6	225
0/6/60/720/2880	60	221
1/6/60/720/2880	60	221
1/6/60/720/2880	60	221
1/6/60/720/2880	60	221
1/6/60/720/2880	60	221





3CR13



3CR13



3CR13



		UE	MOQ	▶ mm
A	7445 CUCHILLO CHULETON ACONCAGUA BLACK aconcagua black steak knife, couteau steak aconcagua black, coltello bistecca acon- cagua black, steak messer aconcagua black	0/6/60/540/2160	60	177
B	7446 CUCHILLO CHULETON ACONCAGUA aconcagua steak knife, couteau steak aconcagua, coltello bistecca aconcagua, steak messer aconcagua	0/6/60/540/2160	60	165
C	3100 CUCHILLO CHULETERO CHURRASCO churrasco steak knife, couteau steak churrasco, couteau steak churrasco, coltello bistecca churrasco, steakmesser churrasco	0/6/60/540/2160	60	254

NEW



		UE	MOQ	▶ mm
A	12016 CUCHILLO CHULETERO KAMET WENGÉ kamet wengé steak knife, couteau steak kamet wengé , coltello bistecca kamet wengé , steak messer kamet wengé	0/6/60/540/2160	60	235
B	12015 CUCHILLO CHULETERO KAMET ROSEWOOD kamet rosewood steak knife, couteau steak kamet rosewood, coltello bistecca kamet rosewood, steak messer kamet rosewood	0/6/60/540/2160	60	235
C	12031 CUCHILLO CHULETERO LHOSTE PAKKA BLACK lhoste pakka steak knife, couteau steak lhoste pakka, coltello bistecca lhoste pakka, steak messer lhoste pakka	0/6/60/540/2160	60	248
D	12032 CUCHILLO CHULETERO LHOSTE PAKKA RED lhoste pakka steak knife, couteau steak lhoste pakka, coltello bistecca lhoste pakka, steak messer lhoste pakka	0/6/60/540/2160	60	248
E	12033 CUCHILLO CHULETERO LHOSTE PAKKA VERDE lhoste pakka steak knife, couteau steak lhoste pakka, coltello bistecca lhoste pakka, steak messer lhoste pakka	0/6/60/540/2160	60	248





* Caja 6 chuleteros.



* Compatible con estuches acacia: 5207 / 5208

- A **7442** CUCHILLO CHULETERO ACR WHITE
acr white steak knife, couteau steak acr white, coltello bistecca acr white, steak
messer acr white
- B **7443** CUCHILLO CHULETERO ACR RED
acr red steak knife, couteau steak acr red, coltello bistecca acr red, steak messer
acr red
- C **3010** CUCHILLO CHULETERO ACR BLACK
steak knife rambo, couteau steak rambo, coltello bistecca rambo, steakmesser
rambo
- 5279** 6 PCS MADERA ACR BLACK
rambo 6 pieces wood, écriin 6 pièces rambo, bauletto in legno 6 pz. rambo, rambo
6 stück holz
- D **3011** TENEDOR CHULETERO ACR NEGRO
zermatt steak knife, couteau steak zermatt, coltello bistecca zermatt, steakmes-
ser zermatt
- 6335** 6 PCS MADERA TENEDOR ACR BLACK
kilimanjaro steak knife, couteau steak kilimanjaro, coltello bistecca kilimanjaro,
steakmesser kilimanjaro
- E **7447** CUCHILLO QUESO ZERMATT
zermatt cheese knife, couteau à fromage zermatt, coltello da formaggio zermatt,
kassmesser zermatt
- F **6163** CUCHILLO CHULETERO ZERMATT
zermatt steak knife, couteau steak zermatt, coltello bistecca zermatt, steakmes-
ser zermatt

UE **MOQ** **mm**

0/6/60/720/3600	60	225
0/6/60/720/3600	60	225
0/6/60/720/3600	60	225
1/6/78/234	6	225
0/6/60/720/3600	60	210
1/6/78/234	6	210
0/6/60/540/2160	60	123
0/6/60/780/3120	60	227

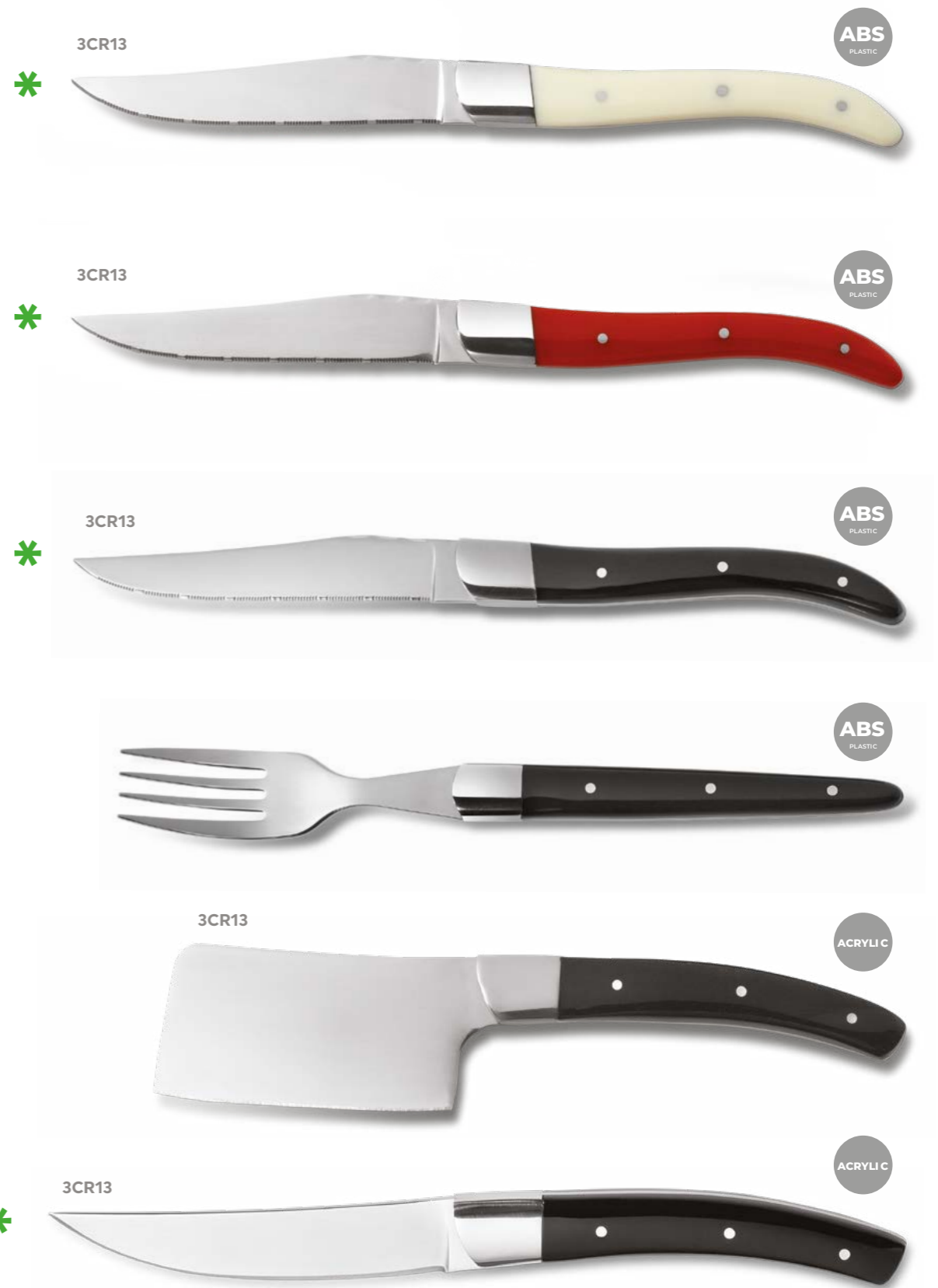



NEW



MIX
6 COLORES
6 COLOURS

REF.: 11993

Sistema de cierre con imán integrado en la madera.

Locking system with magnet integrated in the wood.

Madera de Acacia

Acacia wood



Se recomienda lavar a mano.
Hand washing is recommended



A



B



C



OPCIÓN DE PERSONALIZAR LA CAJA CON LASER.



OPTION TO CUSTOMISE THE BOX WITH LASERMARK.

1,54€ / PIEZA PIECE

- A **11993** CAJA ESTUCHE MADERA 6 CHULETEROS MIX COLORES
wooden 6 steak knives mix coloured case, 6 couteau steak mix couleurs caisse en bois, scatola di legno 6 coltello bisteca colorate mix, 2 steakmesser holzkistewooden
- B **11988** CAJA ESTUCHE MADERA VACÍA 2 CHULETEROS
2 steak knives case, 2 couteau steak caisse en bois, scatola di legno 2 coltello bisteca, 2 steakmesser holzkiste
- C **11987** CAJA ESTUCHE MADERA VACÍA 6 CHULETEROS
wooden 6 steak knives case, 6 couteau steak caisse en bois, scatola di legno 6 coltello bisteca, 2 steakmesser holzkiste

UE	MOQ	L x W x Hmm
1/6	6	260 x 130 x 40
1/2	2	260 x 80 x 35
1/6	6	260 x 130 x 40



HQ: 7Cr17Mov



Conoce UTSET en la página: 494
More about UTSET in page: 494

Corte / Cuchillos de mesa Cutting / Table knives



Se recomienda lavar a mano.
Hand washing is recommended

Acero inoxidable 7Cr17Mov 7Cr17Mov Stainless steel

El acero de los cuchillos de mesa Utset ha sido tratado térmicamente para alcanzar una alta dureza y resistencia al desgaste y durabilidad, lo que significa que mantendrá su filo y estructura en condiciones de uso exigente.

El acero 7Cr17Mov es un tipo de acero que se ha hecho popular en la fabricación de cuchillos gracias a su resistencia a la corrosión.

The steel in Utset table knives has been heat-treated to achieve high hardness and wear resistance and durability, which means it will maintain its sharpness and structure under demanding conditions of use.

7Cr17Mov steel is a type of steel that has become popular in knife making due to its resistance to corrosion.

Madera estabilizada Stabilised wood

Material fabricado mediante la inyección de resinas termoestables y color en la madera. Con esta inyección de resina se obtiene un sellado de mayor dureza, impermeabilidad y resistencia.

Además, con el color podemos personalizar la madera y crear diferentes patrones y variedad de gamas dándole un toque de sofisticación y originalidad al cuchillo.

Material manufactured by injecting thermosetting resins and color into the wood. With this injection, a seal of greater hardness, impermeability and resistance is obtained.

In addition, with colour we can personalise the wood and create different patterns and a variety of ranges, giving a touch of sophistication and originality to the knife.



Conoce
UTSET.



ALTA DUREZA
HIGH HARDNESS
54-1 HRC  5Cr15Mov



Se recomienda lavar a mano.
Hand washing is recommended

	UE	MOQ	✂ mm
A 12005 CUCHILLO ABREOSTRAS CON FUNDA oyster knife with sleeve, couteau à huîtres avec étui, apriostriche con fodero, austernmesser mit scheid	1/6/60	6	148
B 11018 CUCHILLO DE MESA UTSET OLIVO olive knife, couteau a olivier, coltello oliva, olivenmesser	0/6/60/540/2160	6	225
C 11019 CUCHILLO DE MESA UTSET ÉBANO ebony knife, couteau a ebène, coltello ebano, ebenholz-messer	0/6/60/540/2160	6	225
D 11067 CUCHILLO DE MESA MADERA ESTABILIZADA AZUL blue stabilized wood knife, couteau en bois stabilisé bleu, coltello in legno stabilizzato blue, blaues stabilisiertes holzmesser	0/6/60/540/2160	6	225
E 11068 CUCHILLO DE MESA MADERA ESTABILIZADA VERDE green stabilized wood knife, couteau en bois stabilisé vert, coltello in legno stabilizzato verde, grünes stabilisiertes holzmesser	0/6/60/540/2160	6	225
F 11069 CUCHILLO DE MESA MADERA ESTABILIZADA NATURAL natural stabilized wood knife, couteau en bois stabilisé chaud, coltello in legno stabilizzato calce, kalk stabilisiertes holzmesser	0/6/60/540/2160	6	225
G 11070 CUCHILLO DE MESA MADERA ESTABILIZADA NARANJA orange stabilized wood knife, couteau en bois d'orange stabilisé, coltello in legno stabilizzato d'arancio, orange stabilisiertes holzmesser	0/6/60/540/2160	6	225
H 11071 CUCHILLO DE MESA MADERA ESTABILIZADA NEGRA black stabilized wood knife, couteau en bois stabilisé noir, coltello in legno stabilizzato nero, schwarzes stabilisiertes holzmesser	0/6/60/540/2160	6	225
I 11072 CUCHILLO DE MESA MADERA ESTABILIZADA ROJA red stabilized wood knife, couteau en bois stabilisé rouge, coltello in legno stabilizzato rosso, rot stabilisiertes holzmesser	0/6/60/540/2160	6	225

Conoce UTSET en la página: 494
More about UTSET in page: 494

Corte / Cuchillos de mesa
Cutting / Table knives

NEW 

EXTRA DURO
EXTRA HARD
57-59 HRC  7Cr17Mov



MIX
6 COLORES
6 COLOURS

REF.: 11993
PAG.: 203



		UE	MOQ	▶ mm
A	2072 CUCHILLO CHULETERO PERFECT perfect steak knife, couteau steak perfect, coltello bistecca perfect, perfekt steakmesser	0/12/120/1920/5760	120	224
B	5903 TENEDOR CHULETERO PERFECT perfect steak fork, fourchette steak perfect, forchetta bistecca perfect, perfekt steakgabel	0/12/120/1920/7200	120	195
C	2732 CUCHILLO CHULETERO PERFECT PREMIUM perfect premium steak knife, couteau steak perfect premium, coltello bistecca perfect premium, perfekt premium steakmesser	0/12/120/1920/5760	120	224
D	5447 CUCHILLO CHULETERO PERFECT ECO 2 perfect steak knife lacasa, 2 couteau steak perfect lacasa, 2 coltello bistecca perfect lacasa, 2 perfekt steakmesser lacasa	2/0/48/1008/2016	48	215
E	M1538 2 CUCHILLO CHULETERO PERFECT ECO nordic steak knife, couteau steak nordic, coltello bistecca nordic, nordic steakmesser	0/12/120/1920/5760	60	230
F	5631 CUCHILLO CHULETERO NORDIC nordic steak knife, couteau steak nordic, coltello bistecca nordic, nordic steakmesser	0/12/120/1920/5760	120	224
G	4713 CUCHILLO CHULETERO NORDIC ECO nordic steak knife eco, couteau steak nordic eco, coltello bistecca nordic eco, nordic steakmesser eco	0/12/120/1920/5760	120	230
H	1339 CUCHILLO CHULETERO MADRID steak knife, couteau steak madrid, coltello bistecca madrid, steakmesser madrid	0/12/120/1920/5760	120	230



		UE	MOQ	▶ mm	✕ mm
A	3263 CUCHILLO PIZZA pizza knife, couteau pizza, coltello pizza, pizza tafelmesser	0/12/120/1920/5760	120	205	
B	3264 TENEDOR PIZZA pizza fork, fourchette pizza, forchetta pizza, pizza gabel	0/12/120/1920/5760	120	202	4
C	3265 BLISTER 3 CUCHILLO PIZZA blister 3 pizza knife, blister 3 couteau pizza, blister 3 coltello pizza, blister pizza-messer	1/0/24/4561/2280	24	205	
D	3266 BLISTER CUCHILLO + TENEDOR PIZZA blister pizza knife + fork, blister couteau + fourchette pizza, blister coltello + forchetta pizza, blister pizza messer + gabel	1/0/48/576/2304	48	205	4





		UE	MOQ	✂ mm
A	7535 CUCHILLO CHULETERO ROJO PUNTILLA steak knife red couteau steak red coltello bistecca rosso steakmesser rot	1/0/48/1152/2304	24	230
B	8301 BLISTER CHULETERO ROJO PUNTILLA steak knife red 2 blister blister 2 couteau steak red blister 2 coltello bistecca rosso blister 2 steakmesser red	1/0/24/0/0	24	230
C	11585 CUCHILLO CHULETERO NEGRO PUNTILLA steak knife, couteau steak, coltello bistecca, steakmesser	1/0/48/1152/2304	24	230
D	10990 BLISTER 6 CHULETERO FINO SIERRA blister 6 slim serrated steak knife blister 6 couteaux steak avec lame dentelée blister 6 coltelli bistecca lama dentata blister de 6 couteaux à steak avec lame dentelée	1/12/24/0/0	48	215
E	10991 BLISTER 6 CHULETERO FINO LISO blister 6 fine smooth steak knife blister 6 couteaux steak avec lame lisse blister 6 icoltelli bistecca lama liscia blister 6 fine smooth steak knife	1/12/48/0/0	48	215
F	10992 BLISTER 6 CUCHILLO MESA ECO blister 6 eco table knife blister de 6 couteaux table eco blister 6 coltelli tavola eco blister 6 eco table knife	1/12/48/0/0	48	215
G	10993 BLISTER 2 CHULETERO FORJADO blister 2 forged steak knife blister 2 couteaux steak forgés blister 2 coltelli bistecca forgiati blister 2 forged steak knife	1/12/48/0/0	48	225



		UE	MOQ	✂ mm
A	3002 CHULETON NEGRO big black steak knife, gros couteau steak noir, grande coltello bistecca nero, gros steakmesser schwarz	0/12/120/2520/5040	120	232
B	3004 CHULETERO FINO NEGRO black thin steak knife, couteau steak fin noir, coltello bistecca sottile nero, steakmesser schwarz dünn	0/12/120/2880/5760	120	212
C	3003 TENEDOR CHULETERO NEGRO black steak fork, fourchette steak noire, forchetta bistecca nera, steakgabel schwarz	0/12/120/2520/5040	120	191
D	0072 CUCHILLO MANTECA MARFIL ivory knife couteau ivoire coltello avorio elfenbeinmesser	0/12/288/6336/19008	288	200
E	3006 CHULETERO ECO eco steak knife, couteau steak eco, coltello bistecca eco, steakmesser eco	0/6/144/2304/6912	144	220



Acabados y PVD

Finishes and PVD

Sorprende con una nueva forma de vestir la mesa con un toque distinto y elegante gracias a nuestros cubiertos con recubrimiento PVD (Physical Vapor Deposition).

Este innovador proceso no solo otorga un acabado espectacular a cada pieza, sino que también asegura una mayor resistencia y durabilidad, para que tus cubiertos luzcan como nuevos por más tiempo.

El recubrimiento PVD no es solo estética; es una tecnología avanzada que aporta una capa protectora ultra resistente a los arañazos, corrosión y el desgaste del día a día.

Los cubiertos PVD combinan diseño moderno con un rendimiento inigualable. Haz de cada comida una experiencia extraordinaria con la calidad y sofisticación que solo el recubrimiento PVD puede ofrecer.

Surprise with a new way of dressing the table with a different and elegant touch thanks to our cutlery with PVD (Physical Vapor Deposition) coating.

This innovative process not only gives each piece a spectacular finish, but also ensures greater strength and durability, so your cutlery will look as good as new for longer.

PVD coating is not just about aesthetics; it is an advanced technology that provides an ultra-resistant protective layer against scratches, corrosion and everyday wear and tear.

PVD cutlery combines modern design with unrivalled performance. Make every meal an extraordinary experience with the quality and sophistication that only PVD coating can offer.



Acabados Finishes

Escoge el acabado que prefieras para cualquier colección del catálogo.
Choose the finish you prefer for any collection in the catalogue.



VINTAGE

Aspecto antiguo y desgastado que proporciona elegancia a la pieza. Efecto envejecido.

Ancient and worn aspect that gives elegance to the piece. Aged effect.



SATIN

Este tratamiento regala al cubierto un efecto satinado agradable al tacto.

This treatment gives the cover a satin effect pleasant to the touch.



MIRROR

El acabado más extremado, efecto espejo, sumará elegancia y sofisticación a la mesa.

The most extreme finish, mirror effect, will add elegance and sophistication to the table.

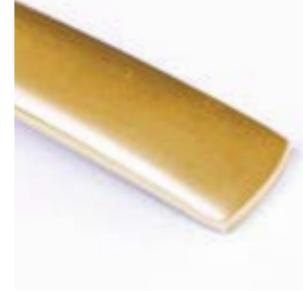

ICE POLVO DE LUNA

Efecto granulado "shot blasting". Acabado mate, suave y liso, que resalta la delicadeza de cada pieza.

"Shot blasting" effect. A matt and smooth finish that stand out the delicacy of every piece.



SILVER PLATE

Dale un toque de distinción a tus cubiertos añadiendo un acabado en plata.

Add a touch of distinction to your cutlery by adding a silver plated.



LASER MARK

Escoge la cubertería y customiza con tu logo cada una de las piezas.

Choose the cutlery and customize each piece with your logo.



TAMPO

Personaliza con los motivos que prefieras las piezas de tu cubertería.

Personalize with the motives that you prefer the pieces of your cutlery.

Plazo entrega 30 días. Delivery time 30 days.



Certificado SGS de calidad.
SGS Quality Certificate.



Garantizado para el contacto con alimentos.
Guaranteed for contact with food.



Garantizado el lavado en lavavajillas.
Guaranteed dishwashing.

COCINA

KITCHEN



218 CORTE / STEAK KNIVES

- 218 TABLAS DE CORTE
- 222 PUNTILLAS
- 224 CUCHILLOS COCINA
 - 226 CARBON
 - 230 IBÉRICA
 - 232 MARBLE
 - 236 ZEN
 - 240 130
 - 242 MESTRE MAURICI
- 246 ACCESORIOS
- 254 RALLADORES Y ACCESORIOS DE CORTE
- 260 ESPÁTULAS

262 UTENSILIOS / UTENSILS

- 262 EMPLATADO
- 264 JUEGOS COCINA
 - 264 MONOBLOCK
 - 266 NYLON
- 274 PASTELERÍA

276 COCCIÓN / COOKING

- 280 SARTENES PROFESIONALES ALUMINIO
- 283 SARTENES PROFESIONALES INOX
- 284 GAMA CROSCAT
- 288 PAELLERAS
- 292 AMT
- 302 RISOLÍ

320 GASTRONORM

- 322 CUBERTAS GN AISI 304 - 18/10
- 326 CUBETAS GN INOX
- 331 CARROS



Download
Cutting
Catalogue



Espesores de 2cm y 3cm.
2cm and 3cm Thicknesses.



Tacos antideslizantes de silicona para un mejor agarre en la superficie.
Silicone anti-slip pads for better grip on the surface.



Mayor rigidez. No se deforma con las altas temperaturas. Máx. 70°C
Higher rigidity, no deformation at high temperatures. Max. 70°C



Apto para contacto con alimentos.
Suitable for food contact.



Apto para lavavajillas.
Dishwasher safe.



Impermeable. No absorbe los líquidos.
SUPERFICIE AUTOCICATRIZANTE
Más higiénica. Evita que se acumule suciedad y bacterias en los cortes.

Waterproof, does not absorb liquids.

AUTOHEAL SURFACE
More hygienic, prevents dirt and bacteria from accumulating in the cuts.



POLIETILENO 500 DE ALTA DENSIDAD DE ALTO PESO MOLECULAR(HD-HMW)

HIGH MOLECULAR WEIGHT HIGH DENSITY POLYETHYLENE 500 (HD-HMW)

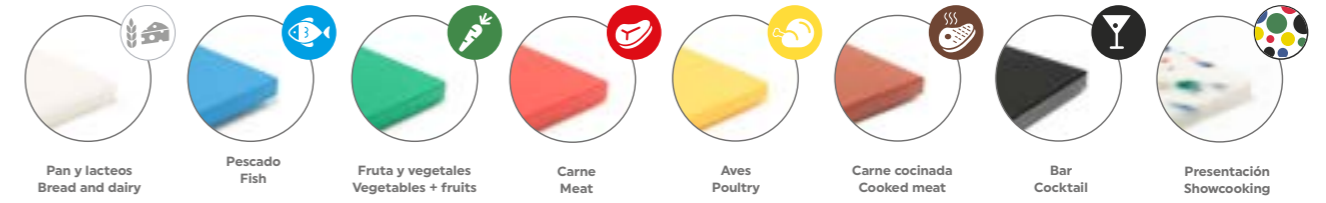

GN 1/1



GN 1/2



20x30cm



30x40cm



40x50cm

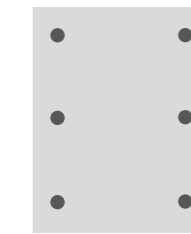

40x60cm

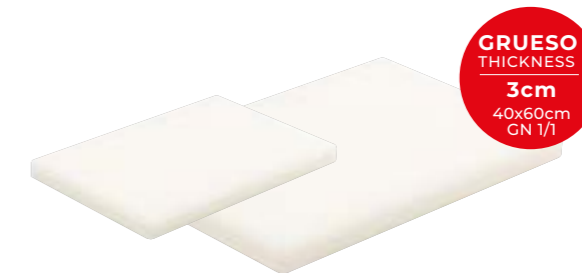
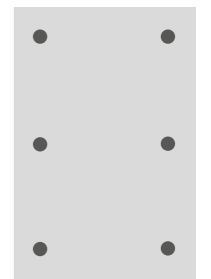

GRUESO THICKNESS
3cm
40x60cm
GN 1/1

Tabla corte pan y lacteos blanca
White cutting board
Planche à découper blanche
Tagliere bianco
Wibes schneidebrett



REF.	W mm	L mm	ESPEJOR cm	TACOS	€	UE / MOQ
NEW 11756	GN 1/1	GN 1/1	3	6		1-0-4 / 1
8523	GN 1/2	GN 1/2	2	6		1-0-10-60-180 / 1
8525	300	200	2	4		1-0-10-60-180 / 1
8526	400	300	2	6		1-0-6-36-108 / 1
8527	500	300	2	6		1-0-6-36-108 / 1
NEW 11758	600	400	3	6		1-0-2 / 1

NEW

Tabla corte bar
Black cutting board
Planche à découper noir
Tagliere nero
Schwarzes schneinebrett



REF.	WxL cm	ESPEJOR cm	TACOS	€	UE / MOQ
11760	30x20	2	4		1-0-5-30-90 / 1
11759	40x30	2	6		1-0-10-60-180 / 1

NEW

Tabla corte presentación
Cutting board presentation
Présentation de la planche à découper
Presentazione del tagliere
Präsentation des Schneebrett



REF.	W.L cm	ESPEJOR cm	TACOS	€	UE / MOQ
11998	30x20	2	4		1-0-8-0-0 / 1

Tabla corte pescado azul
Blue cutting board
Planche à découper bleu
Tagliere blue
Blau schneidebrett



REF.	W mm	L mm	ESPEJOR cm	TACOS	€	UE / MOQ
8529	GN 1/1	GN 1/1	2	6		1-0-5-30-90 / 1
8532	300	200	2	4		1-0-10-60-180 / 1
8533	400	300	2	6		1-0-6-36-108 / 1
8534	500	300	2	6		1-0-6-36-108 / 1
8535	600	400	2	6		1-0-4-24-72 / 1

Tabla corte fruta y vegetales verde
Green cutting board
Planche à découper vert
Tagliere verde
Grün schneidebrett

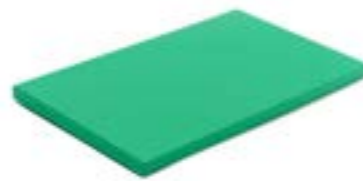

REF.	W mm	L mm	ESPEJOR cm	TACOS	€	UE / MOQ
8536	GN 1/1	GN 1/1	2	6		1-0-5-30-90 / 1
8539	300	200	2	4		1-0-10-60-180 / 1
8540	400	300	2	6		1-0-6-36-108 / 1
8541	500	300	2	6		1-0-6-36-108 / 1
8542	600	400	2	6		1-0-4-24-72 / 1

Tabla corte carne cruda roja
Red cutting board
Planche à découper rouge
Tagliere rosso
Rot schneidebrett



REF.	W mm	L mm	ESPEJOR cm	TACOS	€	UE / MOQ
8543	GN 1/1	GN 1/1	2	6		1-0-5-30-90 / 1
8546	300	200	2	4		1-0-10-60-180 / 1
8547	400	300	2	6		1-0-6-36-108 / 1
8548	500	300	2	6		1-0-6-36-108 / 1
8549	600	400	2	6		1-0-4-24-72 / 1



Tabla corte carne cruda aves amarilla
Yellow cutting board
Planche à découper jaune
Tagliere giallo
Gelb schneidebrett



REF.	W mm	L mm	ESPEJOR cm	TACOS	€	UE / MOQ
8550	GN 1/1	GN 1/1	2	6		1-0-5-30-90 / 1
8553	300	200	2	4		1-0-10-60-180 / 1
8554	400	300	2	6		1-0-6-36-108 / 1
8555	500	300	2	6		1-0-6-36-108 / 1
8556	600	400	2	6		1-0-4-24-72 / 1

Tabla corte carnes cocidas marrón
Brown cutting board
Planche à découper marron
Tagliere marrone
Braun schneidebrett



REF.	W mm	L mm	ESPEJOR cm	TACOS	€	UE / MOQ
8557	GN 1/1	GN 1/1	2	6		1-0-5-30-90 / 1
8560	300	200	2	4		1-0-10-60-180 / 1
8561	400	300	2	6		1-0-6-36-108 / 1
8562	500	300	2	6		1-0-6-36-108 / 1
8563	600	400	2	6		1-0-4-24-72 / 1

NEW

Soporte inox para tablas
Cutting board support
Support planche à découper
Supporto tagliere
Schneidebretthalterung

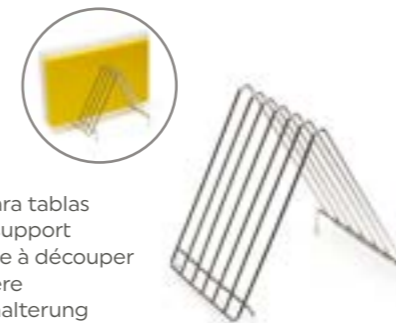

REF.	W mm	L mm	H mm	€	UE / MOQ
11640	265	310	280		1-0-20 / 1

NEW

Rascador para tabla
Cutting board scraper
Brosse pour planche à découper
Spazzola per tagliere
Reinigungsbürste für Schneebrett



REF.	W mm	L mm	H mm	€	UE / MOQ
11761	60	170	90		1-0-36 / 1

NEW

Pack 6 tacos silicona
6 Pack rubber stoppers
Pack 6 tacos silicone
Confezione di 6 tacos in silicone
Pack 6 taco-ständer silikon



REF.	TACOS	€	UE / MOQ
11941	6		1-0-1000 / 1



ACERO:
3Cr13

PP
POLYPROPYLENE

MANGO



Cuchillo multiusos.
Micro serrated knife.



Cuchillo pelador.
Peeling knife.



Cuchillo chuletero.
Steak knife.



Cuchillo fruta micro.
Micro serrated fruit knife.

El 3Cr13MoV es un acero inoxidable sólido que ofrece una buena resistencia a la corrosión, dureza y de fácil afilado. Es ideal para aquellos que quieren un cuchillo de bajo mantenimiento y uso general. Se desempeña de manera óptima en las tareas típicas de corte.

3Cr13MoV is a solid stainless steel that offers good corrosion resistance, hardness and easy sharpening. It is ideal for those who want a low-maintenance, general-purpose knife. It performs optimally in typical cutting tasks.



Cuchillo chuletero
Steak knife
Couteau steak
Coltello bistecca
Steakmesser

REF.	HOJA (mm)	L (mm)	€	UE / MOQ
7535	120	230		1-24-240-7200-21600 / 24
8301	BLISTER 2 U.			1-0-24-360-1440 / 24

sierra microdentada
micro toothed saw



Cuchillo fruta micro
Micro serrated fruit knife
Couteau à fruits micro
Coltello fruta micro
Universalmesser Obst micr

REF.	HOJA (mm)	L (mm)	€	UE / MOQ
7538	88	199		1-24-240-7200-21600 / 24
8304	BLISTER 2 U.			1-0-24-360-1440 / 24

Cuchillo chuletero
Steak knife
Couteau steak
Coltello bistecca
Steakmesser

REF.	HOJA (mm)	L (mm)	€	UE / MOQ
11585	120	230		1-0-24-360-1440 / 24

Cuchillo pelador
Peeling knife
Couteau à éplucher
Coltello spellucchino
Schälmesser

REF.	HOJA (mm)	L (mm)	€	UE / MOQ
11586	80	195		1-0-24-360-1440 / 24

sierra microdentada
micro toothed saw



Cuchillo multiusos micro
Micro serrated utility knife
Couteau multi-usage micro
Coltello multiuso micro
Universalmesser micro

REF.	HOJA (mm)	L (mm)	€	UE / MOQ
7537	100	09		1-24-240-7200-21600 / 24
8303	BLISTER 2 U.			1-0-24-360-1440 / 24



Cuchillo pelador
Peeling knife
Couteau à éplucher
Coltello spellucchino
Schälmesser

REF.	HOJA (mm)	L (mm)	€	UE / MOQ
7536	80	195		1-24-240-7200-21600 / 24
8302	BLISTER 2 U.			1-0-24-360-1440 / 24

Cuchillo multiusos micro
Micro serrated utility knife
Couteau multi-usage micro
Coltello multiuso micro
Universalmesser micro

REF.	HOJA (mm)	L (mm)	€	UE / MOQ
11587	100	09		1-0-24-360-1440 / 24

PACKAGING
BOX





PUNTILLA / MONDADOR / UTILITY

Versátil, tanto para fruta y verdura, como para piezas pequeñas de carne. Versatile, both for fruit and vegetables, as well as for small pieces of meat.



PELADOR / VERDURAS / PEELING

Para trabajos pequeños y delicados. For small and delicate jobs.



DESHUESADOR / WRECKER

Su forma permite acceder a la carne y retirar huesos y tendones sin perder la forma. Its shape allows access to the flesh and the removal of bones and tendons without losing its shape.



JAMONERO / SLICER

Indicado para cortar jamón y carnes curadas. Suitable for cutting ham and cured meats.



SALMÓN / SALMON KNIFE

Hoja fina y alargada, con alvéolos para evitar que la carne se adhiera a la hoja. Thin, elongated blade, with sockets to prevent meat from sticking to the blade.



PANERO / BREAD KNIFE

Hoja dura y dentada que permite cortar alimentos con el exterior rígido con facilidad. Hard, serrated blade for easy cutting of food with a rigid exterior.



HACHA / CLEAVER

Hoja grande y gruesa que se utiliza para cortar y desosar carne cruda o cocinada. A large, thick blade used for cutting and boning raw or cooked meat.



FILETADOR / SLICER

Hoja larga y flexible que permite preparar carne y pescado con precisión. Long, flexible blade for precise meat and fish preparation.



SANTOKU / SANTOKU

Versión japonesa del cuchillo chef, ideal para preparar carne, pesca y verduras. Japanese version of the chef's knife, ideal for preparing meat, fish and vegetables.



CHEF / CHEF

El más popular de los cuchillos, con hoja grande y resistente sirve para todo tipo de cortes. The most popular of the knives, with a large, sturdy blade for all types of cutting.

La gama de productos de corte Comas, ha sido creada y mejorada para ofrecer a los cocineros y jefes de cocina, una amplia variedad de utensilios y cuchillos para corte que garantizan la calidad y durabilidad necesaria para el día a día de las cocinas profesionales.

The Comas range of cutting products has been created and improved to offer chefs and wide variety of cutting utensils and knives that guarantee the quality and durability necessary for everyday use in professional kitchens.



COLECCIÓN
COLLECTION

GRANITE	IBERICA	MARBLE	ZEN	130	MAURICI
---------	---------	--------	-----	-----	---------



MATERIAL	X50 Cr Mo V15	X50 Cr Mo V15	DIN 1.4116	AUS 8 SANMAI	AUS 10 SANMAI	CARBON STEEL 52100
DUREZA DE LA HOJA BLADE HARDNESS	HRC55 ± 57	HRC55 ± 57	HRC55 ± 2	HRC58 ± 2	HRC60 ± 1	HRC62 ± 2
MANGO HANDLE	POLIPROPILENO	POLIPROPILENO	ABS	POM	MADERA DE ÉBANO EBONY WOOD	ABEDUL ESTABILIZADO ABEDUL ESTABILIZADO
ORIGEN MATERIA PRIMA RAW MATERIAL ORIGIN	ALEMANIA GERMANY	ALEMANIA GERMANY	ALEMANIA GERMANY	CHINA CHINA	JAPÓN JAPAN	JAPÓN JAPAN
LAVAVAJILLAS DISHWASHER	✓	✓	✗	✗	✗	✗

El afilado de las hojas hecho manualmente. Garantiza un afilado perfecto y duradero.

Blades sharpening is carried out manually. Guarantees a perfect and durable sharpening.

La forma convexa de la hoja en ambas caras otorga a la hoja un grosor más continuado hasta el filo, garantizando una mayor firmeza en el corte. El pulido asegura un acabado liso e impecable.

The convex line of the blade on both sides grants the blade a more skiving continuing thickness up to the edge, ensuring a steadfast cutting. The polishing ensures a flawless flattening and finishing.

Mangos ergonómicos y antideslizantes para una mayor sujeción.

Ergonomic, non-slip handles for a better grip.



Alta calidad en el corte
 Resistencia a la corrosión

Strong cutting ability
 Resistant to corrosion.



Sello de calidad del fabricante y su compromiso de durabilidad y fiabilidad del producto.

Manufacturer's seal of quality and commitment to product durability and reliability.

TechFlex: Polímeros de PP con EVA para más sensibilidad, adherencia, confort y disminución de fatiga.

TechFlex: Polymers of PP with EVA for a more sensitivity, adhesion, comfort and decreased fatigue

El X50CrMoV15 es un excelente acero inoxidable de gama media que ofrece un rendimiento completo en cuchillos de cocina y cuchillos multiusos con una gran resistencia a la corrosión y una buena retención del filo. Es fácil de afilar, por lo que es ideal para aquellos que prefieren cuchillos de bajo mantenimiento que se pueden mantener afilados sin necesidad de un afilado profesional.

X50CrMoV15 is an excellent mid-range stainless steel that offers all-round performance in kitchen knives and utility knives, with high corrosion resistance and good edge retention. It is easy to sharpen, making it ideal for those who prefer low maintenance knives that can be kept sharp without the need for professional sharpening.



- 10074
 - 10093
 - 10104
 - 10114
 - 10128
- Cuchillo chef 180**
 Chef knife 180
 Couteau de cuisine 180
 Coltello chef 180
 Kochmesser 180

UE / MOQ:
 1-12-144-576-1728 / 12



- 10075
 - 10094
 - 10105
 - 10115
 - 10129
- Cuchillo chef 200**
 Chef knife 200
 Couteau de cuisine 200
 Coltello chef 200
 Kochmesser 200

UE / MOQ:
 1-12-72-288-864 / 12



- 10076
 - 10095
 - 10106
 - 10116
 - 10130
- Cuchillo chef 250**
 Chef knife 250
 Couteau de cuisine 250
 Coltello chef 250
 Kochmesser 250

UE / MOQ:
 1-12-72-288-864 / 12



- 10077
 - 10096
 - 10107
 - 10117
 - 10131
- Cuchillo chef 300**
 Chef knife 300
 Couteau de cuisine 300
 Coltello chef 300
 Kochmesser 300

UE / MOQ:
 1-6-48-192-576 / 6



- 10079
- 10098
- 10109
- 10119

Cuchillo carnicero 160
Butcher knife 160
Couteau boucher 160
Coltello scannare 160
Fleischermesser 180

UE / MOQ:
1-12-144-576-1728 / 12



- 10080
- 10099
- 10110
- 10120

Cuchillo carnicero 180
Butcher knife 180
Couteau boucher 180
Coltello scannare 180
Fleischermesser 180

UE / MOQ:
1-12-144-576-1728 / 12



- 10081
- 10100
- 10111
- 10121

Cuchillo carnicero 200
Butcher knife 200
Couteau boucher 200
Coltello scannare 200
Fleischermesser 200

UE / MOQ:
1-12-72-288-864 / 12



- 10082
- 10101
- 10112
- 10122

Cuchillo carnicero 240
Butcher knife 240
Couteau boucher 240
Coltello scannare 240
Fleischermesser 240

UE / MOQ:
1-12-72-288-864 / 12



- 10083
- 10102
- 10113
- 10123

Cuchillo carnicero 300
Butcher knife 300
Couteau boucher 300
Coltello scannare 300
Fleischermesser 300

UE / MOQ:
1-6-48-192-576 / 6



- 10092

Cuchillo chuletero 130
Steak knife 130
Couteau à steak 130
Coltello per bistecca 130
Steakmesser 130

UE / MOQ:
1-12-60-240-720 / 12



- 10078
- 10097
- 10108
- 10118

Cuchillo deshuesador 140
Wrecker knife 140
Couteau de desossage 140
Coltello disossato 140
Ausbeinmesser 140

UE / MOQ:
1-12-144-576-1728 / 12



- 10084
- 10127

Cuchillo pan y pastelero 250
Bread and pastry knife 250
Couteau à pain et pâtisserie 250
Coltello pane 250
Brotmesser 250

UE / MOQ:
1-12-72-288-864 / 12



- 10085
- 10124

Cuchillo para fiambres 300
Slicing knife 300
Couteau à charcuterie 300
Coltello affettati 300
Tranchiermesser 300

UE / MOQ:
1-6-48-192-576 / 6



- 10086
- 10103
- 10125

Cuchillo salmón 300
Salmon knife 300
Couteau saumon 300
Coltello salmone 300
Lachsmesser 300

UE / MOQ:
1-6-48-192-576 / 6



- 10087
- 10126

Cuchillo jamonero 280
Ham knife 280
Couteau à jambon 280
Coltello prosciutto 280
Schinkenmesser 280

UE / MOQ:
1-6-48-192-576 / 6



Los cuchillos de la línea IBÉRICA al igual que GRANITE, están fabricados en acero X50 CrMo V15 y pueden ser utilizados para cortar o filetear gracias a su fino espesor. Esta gama presenta un mango moderno, ergonómico y antideslizante que garantiza un mayor confort y seguridad en su uso.

The knives of the IBÉRICA line, like GRANITE, are made of X50 CrMo V15 steel and can be used for cutting or filleting thanks to their thin thickness. This range has a modern, ergonomic and non-slip handle that guarantees greater comfort and safety in use.

Ideal para cortar o filetear.
Ideal for slicing or filleting.

Mango ergonómico y antideslizante.
Ergonomic, non-slip handle.

Hoja de bajo espesor que lo hace ligero y facilita el manejo.
Thin blade makes it light and easy to handle.



Macheta 180
Cleaver 180
Couperet 180
Mannaietta 180
Hackmesser 180

REF.	HOJA (mm)	L(mm)	€	UE / MOQ
● 10088	180/7"	300		1-12-12-48-144 / 12



Hachuela 250
Cleaver 250
Couperet 250
Mannaietta 250
Hackmesser 250

REF.	HOJA (mm)	L(mm)	€	UE / MOQ
● 10089	250/10"	345		1-12-12-48-144 / 12



Macheta filetera 220
Fillets cleaver 220
Couperet filet 220
Mannaietta per affettare 220
Filetirmesser 220

REF.	HOJA (mm)	L(mm)	€	UE / MOQ
● 10090	220/8'6"	315		1-6-6-24-72 / 6



Macheta filetera 280
Fillets cleaver 280
Couperet filet 280
Mannaietta per affettare 280
Filetirmesser 280

REF.	HOJA (mm)	L(mm)	€	UE / MOQ
● 10091	280/11"	362		1-6-6-24-72/6

ACERO:
GERMAN
STEEL
DIN 1.4116

DUREZA:
HRC55 ± 2

ABS
PLASTIC
MANGO

La colección Marble está creada por 12 cuchillos exclusivos. Están realizados en acero alemán que garantiza la calidad por su alta resistencia. Este conjunto, caracterizado por su diseño funcional, destaca por su elegante color blanco. El aliado perfecto para cualquier profesional de la cocina

The Marble collection consists of 12 exclusive knives. They are made of German steel, which guarantees quality and high resistance. This set, characterised by its functional design, stands out for its elegant white colour. The perfect ally for any kitchen professional.



El acero alemán DIN 1.4116 es reconocido por su calidad excepcional y versatilidad, que lo convierte en uno de los materiales preferidos en la fabricación de cuchillos.

Su composición equilibrada ofrece una resistencia superior al desgaste y la oxidación, esto significa que mantienen el filo durante más tiempo y resisten un uso intensivo, algo esencial para los chefs.

German DIN 1.4116 steel is renowned for its exceptional quality and versatility, making it one of the preferred materials in knife making.

Its balanced composition offers superior resistance to wear and oxidation, which means it holds its edge longer and withstands intensive use - essential for chefs.



FILO: Afilado en "V" para una mejor precisión en el corte.

EDGE: With "V"-grind for a finer cut.

HOJA: Fabricado con acero alemán de alta calidad: DIN1.4116 HRC55 ± 2.

BLADE: Made with high-quality German steel: DIN1.4116 HRC55 ± 2.

Proceso de endurecimiento de la hoja en frío para un afilado duradero y resistente al óxido.

Cold-hardened blade for a long-lasting, rust-free grind.

REFUERZO: Cabezal cónico para un agarre cómodo y seguro.

REINFORCEMENT: Cone-shaped bolster for a comfortable, secure grip.

MANGO: Diseño ergonómico para un mejor agarre, proporcionando el equilibrio perfecto en la sujeción del cuchillo.

HANDLE: Ergonomically designed for better grip, giving perfect balance in the hand.



Remaches resistentes a la corrosión. Fabricado en ABS, le proporciona una mayor dureza y una alta resistencia al calor.

Rust-resistant rivets. Made from boron steel which makes it tougher and more heat resistant.

Talón acabado en acero inoxidable que proporciona protección y mayor robustez al mango.

Butt finished in stainless steel to provide protection and make the handle more durable.

Cocina / Kitchen
MARBLE COLLECTION

ACERO:
GERMAN
STEEL
DIN 1.4116

DUREZA:
HRC55 ±2



Cuchillo chef 20
Chef knife 20
Couteau de cuisine 20
Coltello chef 20
Kochmesser 20

REF.	HOJA (mm)	L (mm)	€	UE / MOQ
8108	200/8"	320		1-6-36-144-432 / 6



Cuchillo chef 25
Chef knife 25
Couteau de cuisine 25
Coltello chef 25
Kochmesser 25

REF.	HOJA (mm)	L (mm)	€	UE / MOQ
8117	250/10"	380		1-6-36-216-432 / 6



Cuchillo mini Santoku
Mini Santoku knife
Couteau mini Santoku
Coltello mini Santoku
Mini Santoku-Messer

REF.	HOJA (mm)	L (mm)	€	UE / MOQ
8112	115/5"	230		1-6-48-288-576 / 6



Cuchillo verduras
Utility knife
Couteau à légumes
Coltello multiuso
Universalmesser

REF.	HOJA (mm)	L (mm)	€	UE / MOQ
8113	125/5"	230		1-6-48-288-576 / 6



Cuchillo fileteador
Carving knife
Couteau à filet
Coltello per affettare
Tranchiermesser

REF.	HOJA (mm)	L (mm)	€	UE / MOQ
8109	200/8"	320		1-6-36-144-432 / 6



Cuchillo panero
Bread knife
Couteau à pain
Coltello pane
Brotmesser

REF.	HOJA (mm)	L (mm)	€	UE / MOQ
8110	200/8"	320		1-6-36-144-432 / 6



Cuchillo chuletero
Steak knife
Couteau à steak
Coltello per bistecca
Steakmesser

REF.	HOJA (mm)	L (mm)	€	UE / MOQ
8114	115/4,5"	220		1-6-48-288-576 / 6



Cuchillo Mondador
Paring knife
Couteau d'office
Coltello sbucciatore
Schälmesser

REF.	HOJA (mm)	L (mm)	€	UE / MOQ
8115	80/3,5"	190		1-6-48-288-576 / 6



Cuchillo Santoku
Santoku knife
Couteau Santoku
Coltello Santoku
Santoku-Messer

REF.	HOJA (mm)	L (mm)	€	UE / MOQ
8111	165/7"	300		1-6-36-144-432 / 6



Cuchillo jamonero
Slicing knife
Couteau à jambon
Coltello da prosciutto
Schinkenmesser

REF.	HOJA (mm)	L (mm)	€	UE / MOQ
8116	260/10"	385		1-6-36-144-432 / 6



Cuchillo deshuesador
Boning knife
Couteau de désossage
Coltello disossato
Ausbeinmesser

REF.	HOJA (mm)	L (mm)	€	UE / MOQ
8118	155/7,8"	280		1-6-36-216-432 / 6

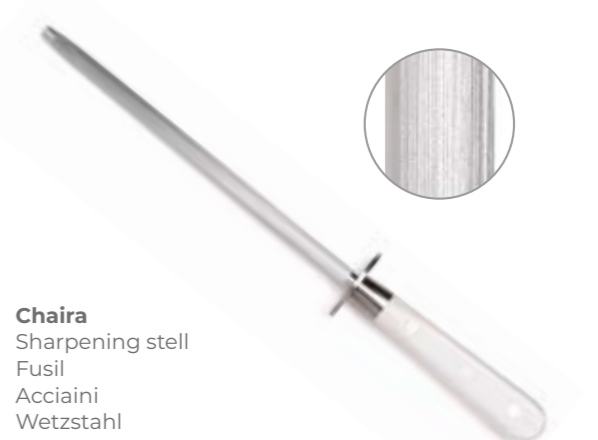

Chaira
Sharpening stell
Fusil
Acciaini
Wetzstahl

REF.	HOJA (mm)	L (mm)	€	UE / MOQ
8119	205/7,8"	325		1-6-36-216-432 / 6



ACERO:
AUS8

DUREZA:
HRC 58±2



La colección de cuchillos ZEN está diseñada para perdurar en el tiempo. Se caracteriza por su diseño elegante y minimalista que refleja la estética japonesa convirtiéndola en una pieza tradicional, innovadora e imprescindible para complementar cualquier cocina.

Esta colección es ideal para aquellos que buscan calidad, rendimiento y belleza en una sola herramienta. El filo tiene un excelente afilado que facilita el corte preciso de cualquier ingrediente.

The ZEN knife collection is designed to last over time. It is characterised by its elegant and minimalist design that reflects Japanese aesthetics, making it a traditional, innovative and essential piece to complement any kitchen.

This collection is ideal for those looking for quality, performance and beauty in a single tool. The cutting edge has an excellent sharpness that facilitates the precise cutting of any ingredient.

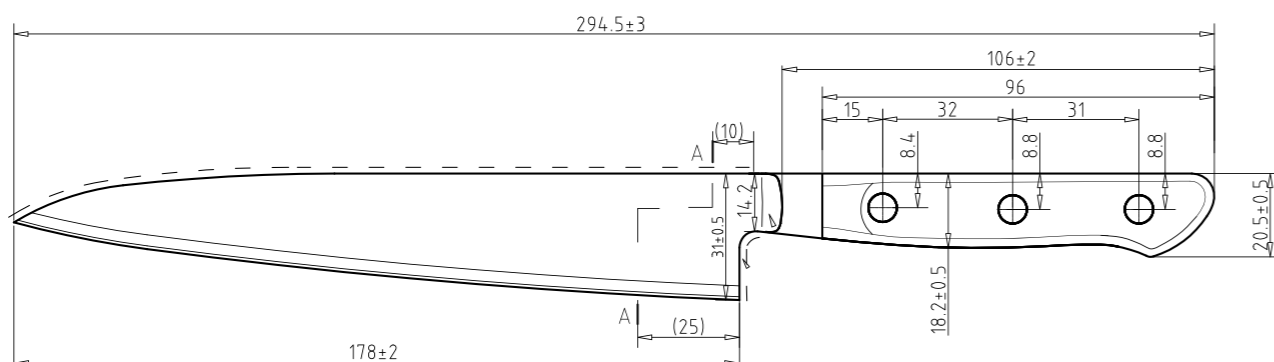

ACERO SAN MAI 3 CAPAS
SAN MAI STEEL 3 LAYERS

Exterior:
Acero inoxidable al cromo 13

Outer layers:
13 chrome stainless steel.

Núcleo:
Acero de aleación (AUS8)

Core: Alloy steel (AUS8)

Diseño ergonómico para un mejor agarre. Acabado suave y satinado.

Ergonomic design for a better grip.

SAN MAI, significa "3 capas" en japonés y es una técnica tradicional de forjado de cuchillos que consiste en la combinación de diferentes tipos de acero con en una estructura laminada, con el fin de aprovechar las mejores características de cada material.

NÚCLEO: El AUS-8 es una opción versátil para los cuchillos de acero inoxidable. Es un acero con un rendimiento sólido.

EXTERIOR: A ambos lados del núcleo encontramos un acero más suave y resistente a la corrosión, protegiendo el núcleo de impactos y roturas.



Afilado en "V" para una mejor precisión en el corte.

With V-grind for a finer cut.

Viola 18/0 con estructura de espiga completa.

18/10 Ferrule full tang structure.

SAN MAI, which means '3 layers' in Japanese, is a traditional knife forging technique that consists of combining different types of steel in a laminated structure, in order to take advantage of the best characteristics of each material.

CORE: AUS-8 is a versatile choice for stainless steel knives. It is a steel with a solid performance.

EXTERIOR: On both sides of the core is a softer, corrosion resistant steel, protecting the core from impact and breakage.

ACERO:
AUS8

DUREZA:
HRC 58±2

POM
PLASTIC
MANGO



NEW



PACKAGING
BOX

Cuchillo santoku
Santoku zen knife
Couteau santoku
Coltello santoku
Santoku-Messer

REF.	HOJA (mm)	L (mm)	€	UE / MOQ
10968	165	295		1-6-36-0-0/1



Cuchillo puntilla
Peeling knife
Couteau éplucheur
Coltello da cucina professionale
Schälmesser

REF.	HOJA (mm)	L (mm)	€	UE / MOQ
10964	90	205		1-6-36-0-0/1



Cuchillo fileteador
Slice knife
Couteau tranche
Coltello fetta
Tranchiermesser

REF.	HOJA (mm)	L (mm)	€	UE / MOQ
10966	180	290		1-6-36-0-0/1



Cuchillo verduras
Vegetable knife
Couteau à légumes
Coltello per verdure
Gemüsemesser

REF.	HOJA (mm)	L (mm)	€	UE / MOQ
10965	145	275		1-6-36-0-0/1



Cuchillo chef
Chef's knife
Couteau chef
Coltello chef
Küchenmesser

REF.	HOJA (mm)	L (mm)	€	UE / MOQ
10967	210	335		1-6-36-0-0/1



Cuchillo nakiri
Nakiri knife
Couteau nakiri
Coltello nakiri
Nakiri messer

REF.	HOJA (mm)	L (mm)	€	UE / MOQ
10969	165	295		1-6-36-0-0/1



Cuchillo fileteador
Sharpening stone
Fusil
Acciaini
Tranchiermesser

REF.	HOJA (mm)	L (mm)	€	UE / MOQ
10970	240	365		1-6-36-0-0/1

Cuchillo chef
Chef's knife
Couteau chef
Coltello chef
Küchenmesser



REF.	HOJA (mm)	L (mm)	€	UE / MOQ
11022	210MM	365		1-0-0-0-0 / 1

Cuchillo fileteador
Carving knife
Couteau à filet
Coltello sfilettatore
Filetirmesser



REF.	HOJA (mm)	L (mm)	€	UE / MOQ
11605	235MM	385MM		1-0-0-0-0 / 1

Cuchillo Puntilla
Paring Knife
Couteau À Pointe
Coltello Da Cucina Professionale
Ausbeinmesser



REF.	HOJA (mm)	L (mm)	€	UE / MOQ
11024	100MM	213MM		1-0-0-0-0 / 1

Cuchillo Fileteador
Carving Knife
Couteau À Filet
Coltello Sfilettatore
Filetirmesser



REF.	HOJA (mm)	L (mm)	€	UE / MOQ
11023	180MM	320MM		1-0-0-0-0 / 1

Cuchillo Kiritsuke
Kiritsuke Knife
Couteau Kiritsuke
Coltello Kiritsuke
Kiritsuke-Messer



REF.	HOJA (mm)	L (mm)	€	UE / MOQ
11606	170MM	313MM		1-0-0-0-0 / 1



PIN
Mosaico de la familia UTSET con sus cuatro puntos generacionales.

Mosaic of the UTSET family with its four generational points.



HOJA / BLADE
Acero japonés
SANMAI AUS10
Dureza 60 1 HRC

Japanese steel
SANMAI AUS10
Hardness 60 1 HRC

VIROL / FERRULE
Diseñada para distintos agarres.
Anillo de raíz estabilizada.

Designed for different grips. stabilised root ring.

MANGO / HANDLE
Cuerpo de madera de ébano.

Ebony wood body.

El acero japonés AUS10 destaca como una opción versátil y de alta calidad entre los aceros japoneses para cuchillos.

Japanese AUS10 stands out as a versatile and high quality choice among Japanese knife steels.

Con una dureza notable que oscila entre 58 y 60 HRC y un contenido en cromo de aproximadamente el 13%, este acero ofrece una excelente resistencia a la corrosión, garantizando una larga durabilidad y rendimiento.

With a remarkable hardness ranging from 58 to 60 HRC and a chromium content of approximately 13%, this steel offers excellent corrosion resistance, ensuring long durability and performance.

Cuchillo Panero
Bread knife
Couteau à pain
Coltello da pane
Brotmesser

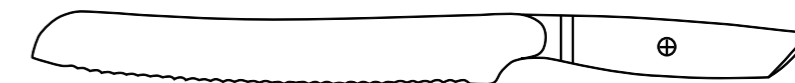

REF.	HOJA (mm)	L (mm)	€	UE / MOQ
12020	235MM	385MM		1-0-0-0-0 / 1

Tenedor Trinchador
Carving fork
Fourchette à découper
Forchetta da intaglio
Tranchiergabel

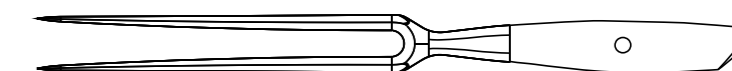

REF.	HOJA (mm)	L (mm)	€	UE / MOQ
12021	160MM	306MM		1-0-0-0-0 / 1

ACERO JAPONÉS:
 52100
 HOJA ENNEGRECIDA

DUREZA:
 62 ± 2 HRC



Acero de carbono

El 52100 es un acero al cromo con alto contenido en carbono que ha ganado popularidad en el mundo de la cuchillería para hojas de alto rendimiento.

Conocido por su excepcional dureza, resistencia al desgaste y retención del filo, se utiliza a menudo en cuchillos personalizados de gama alta que requieren una durabilidad superior.

Al ser un cuchillo no inoxidable, se le ha aplicado una pátina negra en toda la hoja para evitar que se oxide fácilmente. Aún así aconsejamos lavarlo siempre a mano y secarlo rápido.

Si se guarda durante tiempo es aconsejable untar de aceite mineral la hoja y la espiga así como guardarlo protegido con funda o saya.

Carbon steel

52100 is a high-carbon chrome steel that has gained popularity in the world of high-performance knife making.

Known for its exceptional hardness, wear resistance and edge retention, it is often used in high-end custom knives that require superior durability.

As a non-stainless knife, a black patina has been applied to the entire blade to prevent it from rusting easily. Even so, we advise to always wash it by hand and dry it quickly.

If it is stored for a long time, it is advisable to smear mineral oil on the blade and tang and to keep it protected with a saya.



Raíz de abedul estabilizada

El mango, de raíz de abedul estabilizada proporciona a la colección la elegancia de una madera noble.

El proceso de estabilización protege y sella la porosidad de la madera para garantizar una mayor durabilidad y resistencia, además de resultar muy agradable al tacto.

Aún siendo un material duradero y resistente es importante evitar el lavavajillas y mantener siempre el cuchillo seco.

Stabilised birch root

The handle, made of stabilised birch root, gives the collection the elegance of a noble wood.

The stabilisation process protects and seals the porosity of the wood to ensure greater durability and strength, as well as being very pleasant to the touch.

Yet being a durable and resistant material, it is important to avoid dishwashing and to always keep the knife dry.



Conoce UTSET en la página: 494
 More about UTSET in page: 494

NEW

HASAKI

Parte afilada que se convierte en el filo del cuchillo.

The sharp part that becomes the cutting edge of the knife.

Hoja fabricada con acero al carbono, conocido por su capacidad de mantener un filo excepcional y su facilidad para ser afilados.

Blade made of carbon steel, known for its ability to maintain an exceptional sharpness and ease of sharpening.

HAMOTO

Parte del filo cerca del mango. Al cortar pescado crudo para hacer sashimi, normalmente se corta desde el hamoto.

Part of the blade near the handle. When cutting raw fish for sashimi, it is usually cut from the hamoto.

KIREHA

Parte final de la hoja, normalmente con forma curva para facilitar el agarre del cuchillo.

The end of the blade, usually curved to make it easier to grip the knife.

PASADOR PIN MOSAICO

Con 4 puntos de acero que representan las 4 generaciones con 130 años de experiencia y pasión por los cuchillos

With 4 steel points representing the 4 generations with 130 years of experience and passion for knives.

KISSAKI

La punta de la hoja. Puede variar de forma según el tipo de cuchillo. Se utiliza el realizar cortes en carnes y pescado o en esculpir verduras

The tip of the blade. It can vary in shape depending on the type of knife. Used for cutting meat and fish or carving vegetables.

MINE

Columna vertebral de la hoja. Parte opuesta al filo.

Spine of the blade. The part opposite the blade.

AGO

Parte más ancha y gruesa de la hoja. Se usa para tareas que requieren más precisión, como cortar alimentos más duros.

The wider, thicker part of the blade. Used for tasks requiring more precision, such as cutting harder foods.

E

Cuerpo principal del mango.

Main body of the handle.

Mango fabricado con raíz de abedul estabilizada. Muy agradable al tacto y mucho más resistente al lavado.

Handle made of stabilised birch root. Very pleasant to the touch and much more resistant to washing.



Cuchillo Chef
 Chef's knife
 Couteau chef
 Coltello chef
 Küchenmesser



REF.	HOJA (mm)	L (mm)	€	UE / MOQ
11608	215MM	351MM		1-0-0-0-0- /1

Cuchillo Fileteador
 Slicer
 Couteau à filet
 Coltello sfilettatore
 Filetiermesser



REF.	HOJA (mm)	L (mm)	€	UE / MOQ
11609	185MM	312MM		1-0-0-0-0- /1

Cuchillo Puntilla
 Utility knife
 Couteau à pointe
 Coltello da cucina
 Ausbeinmesser



REF.	HOJA (mm)	L (mm)	€	UE / MOQ
11610	100MM	212MM		1-0-0-0-0- /1

Cuchillo Fileteador
 Slicer
 Couteau à filet
 Coltello sfilettatore
 Filetiermesser



REF.	HOJA (mm)	L (mm)	€	UE / MOQ
11657	235MM	367MM		1-0-0-0-0- /1

Cuchillo Kiritsuke
 Kiritsuke knife
 Couteau Kiritsuke
 Coltello Kiritsuke
 Kiritsuke-Messer



REF.	HOJA (mm)	L (mm)	€	UE / MOQ
11658	170MM	300MM		1-0-0-0-0- /1

Cuchillo Verduras
 Petty knife
 Couteau à légumes
 Coltello per verdure
 Gemüsemesser



REF.	HOJA (mm)	L (mm)	€	UE / MOQ
11659	150MM	265MM		1-0-0-0-0- /1

Cuchillo Santoku
 Santoku Knife
 Couteau Santoku
 Coltello Santoku
 Santoku-Messer



REF.	HOJA (mm)	L (mm)	€	UE / MOQ
11660	170MM	302MM		1-0-0-0-0- /1



Funda Saya Madera
 Saya wooden sheath
 Étui en bois saya
 Custodia saya in legno
 Holzkiste saya

REF.	CUCHILLO / KNIFE	L (mm)	€	UE / MOQ
11083	CHEF	215		1-12-120-0-0 /1
11084	FILETEADOR	185		1-12-120-0-0 /1
11085	PUNTILLA	150		1-12-120-0-0 /1
11086	FILETEADOR	235		1-12-120-0-0 /1
11087	KIRITSUKE	170		1-12-120-0-0 /1
11088	VERDURAS	150		1-12-120-0-0 /1
11661	SANTOKU	170		1-12-120-0-0 /1



Madera de acacia de alta calidad.

High quality acacia wood.

4 lados magnéticos.

4 magnetic sides.

Base de acero inoxidable con almohadillas antideslizantes.

Stainless steel base with non-slip pads.

Giratorio 360°

360° rotatable



NEW

Iman Taco Rotable Cuchillos
Rotating Magnet Knife Display
Aimant Taco Rotatif Pour Couteaux
Barra Magnetica Taco Rotabile Coltelli
Drehbarer Tischmagnet für Messer



REF.	L(mm)	W(mm)	H(mm)	€	UE / MOQ
11636	105	105	280	55,70	1-0-4-0-0 / 1



NEW

Iman Sobremesa Cuchillos
Tabletop Magnet Knife Display
Aimant De Table Pour Couteaux
Barra Magnetica Portacoltelli
Tischmagnet für Messer



REF.	L(mm)	W(mm)	H(mm)	€	UE / MOQ
11038	90	280	245	51,56	1-0-5-0-0 / 1



NEW

Expositor Madera Cuchillo Chef
Wooden Chef'S Knives Display
Présentoir En Bois Pour Couteau De Chef
Espositore In Legno Coltelli Chef
Messerhalter für Küchenmesser



REF.	L(mm)	W(mm)	H(mm)	€	UE / MOQ
11637	340	80	180		1-0-10-0-0 / 1





Imán pared madera
Wooden wall magnet
Porte-couteaux magnetic
Barra magnetica legno
Magnetleiste für Messer Holz



REF.	L(mm)	H(mm)	€	UE / MOQ
8471	460	67		1-0-8-88-264 / 6



Imán pared inox
Magnetic bar inox
Porte-couteaux magnetic inox
Barra magnetica inox
Magnetleiste für Messer inox



REF.	L(mm)	H(mm)	€	UE / MOQ
8470	350	47		1-6-8-144-288 / 6



Imán pared PP
PP magnetic bar
Porte-couteaux magnetic PP
Barra magnetica PP
Magnetleiste für Messer PP



REF.	L(mm)	H(mm)	€	UE / MOQ
8472	550	50		1-6-12-108-432 / 6



Madera de acacia de alta calidad.

High quality acacia wood.

Tratada con aceites naturales para resaltar su color y protegerla de la humedad.

Treated with natural oils to enhance its colour and protect it from moisture.

Grosor considerable para mayor durabilidad y estabilidad.

Substantial thickness for durability and stability.



Hendiduras laterales para el agarre. Facilitan el levantamiento y transporte, incluso cargada con alimentos.

Side grooves for gripping and easy lifting and transport, even when loaded with foodstuffs.

Tacos de goma antideslizantes. Colocados en las esquinas, evitan que la tabla se deslice durante su uso, proporcionando estabilidad.

Non-slip rubber pads on the corners prevent the board from slipping during use and provide stability.



Tabla madera acacia
Acacia wood board
Planche en bois d'acacia
Tavola in legno di acacia
Akazienholzplatte



REF.	W(mm)	L(mm)	H(mm)	€	UE / MOQ
12034	400	320	38		1-0-0 / 1



Corte / Accesorios de corte
Cutting / Cutting accessories

El patrón de bolques END GRAIN ofrece mayor resistencia al desgaste y menor daño a los cuchillos.

The END GRAIN bolt pattern offers greater wear resistance and less damage to knives.

Ideal para mantener la piedra fija durante el proceso de afilado.

Ideal for holding the stone in place during the sharpening process.

Soporte de caucho ajustable a distintos tamaños de piedras.

Adjustable rubber support for different stone sizes.

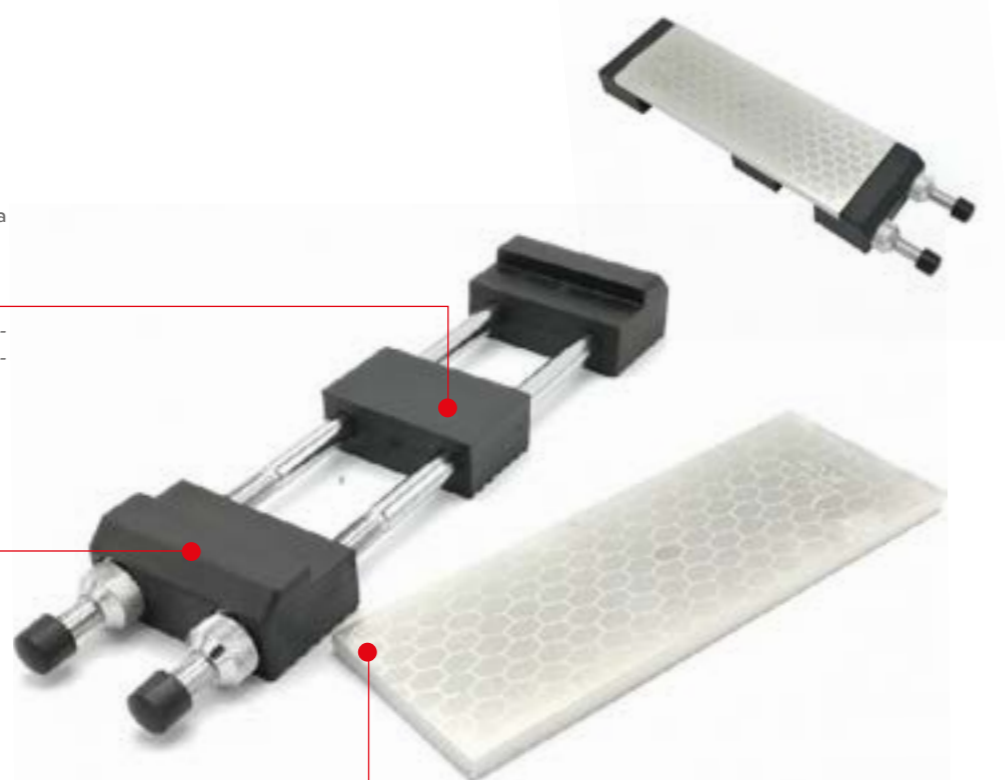

Placa diamantada de doble cara (grano 400 / 1000) y doble función: reparación de hojas dañadas y realizar un filo completamente nuevo. También la podemos usar para aplanar y limpiar las piedras de afilar usadas.

Double-sided diamond plate (grit 400/1000) with double function: repairing damaged blades and making a completely new cutting edge. It can also be used to flatten and clean used whetstones.

NEW

Placa diamantada para afilado con soporte

Diamond encrusted sharpening and levelling stone with stand
Plaque diamantée pour affûtage et aplatissage avec support
Piastra diamantata per affilare e appiattare con supporto
Diamantschleifstein mit Haltern

REF.	L(mm)	W(mm)	H(mm)	€	UE / MOQ
11939	286	70	30		1-0-10-0-0 / 1



Piedra afilar

Whetstone
Pierre à aiguiser
Cote
Schärfstein Messer

REF.	L(mm)	€	UE / MOQ
6958	180		1-0-16-176-528 / 2



Afilador mango

Two stage knife sharpener
Affûteur couteau
Arrotino
Messerschärfer mit Griff

REF.	L(mm)	€	UE / MOQ
6957	190		1-0-36-180-360 / 6



Puente bambú piedra afiladora

Bamboo sharpening stone
Pierre à aiguiser en bambou
Pietra per affilare in bambù
Schärfstein aus bambus

* No incluye piedra de afilar
Sharpening stone not includes

REF.	L(mm)	W(mm)	H(mm)	€	MOQ
11029	430	100	90		1-0-0-0-0 / 1



Piedra de afilar 1000

Sharpening stone 1000
Pierre a aiguiser 1000
Pietra per affilare 1000
Schärfstein 1000

REF.	L(mm)	W(mm)	H(mm)	€	MOQ
11031	210	70	25		1-0-0-0-0 / 1



Piedra de afilar 5000

Sharpening stone 5000
Pierre a aiguiser 5000
Pietra per affilare 5000
Schärfstein 5000

REF.	L(mm)	W(mm)	H(mm)	€	MOQ
11033	210	70	25		1-0-0-0-0 / 1



Asentador

Strop
Strop
Strop
Strop

REF.	L(mm)	W(mm)	H(mm)	€	MOQ
11037	350	80	45		1-0-0-0-0 / 1



Piedra de afilar 400

Sharpening stone 400
Pierre a aiguiser 400
Pietra per affilare 400
Schärfstein 400

REF.	L(mm)	W(mm)	H(mm)	€	MOQ
11030	210	70	25		1-0-0-0-0 / 1



Piedra de afilar 3000

Sharpening stone 3000
Pierre a aiguiser 3000
Pietra per affilare 3000
Schärfstein 3000

REF.	L(mm)	W(mm)	H(mm)	€	MOQ
11032	210	70	25	139,50	1-0-0-0-0 / 1



Placa acero diamantada

Diamond steel plate
Plaque en acier diamant
Piastra in acciaio diamantato
Diamant-stahlplatte

REF.	L(mm)	W(mm)	H(mm)	€	MOQ
11034	203	76	10		1-0-0-0-0 / 1



El maletín es la mejor opción para mantener tus cuchillos organizados y con el filo protegido para un afilado duradero.

La manera más segura de transportar tu selección de cuchillos donde necesites.

The Knife roll is the best option to keep your knives organised and edge protected for long-lasting sharpness

The safest way to transport your knife selection wherever you need it.

2 cierres de plástico de alta seguridad

2 high-security plastic closures

Tela adicional con cremallera para proteger los cuchillos

The long cuffs provide extra protection for your forearms.

Bolsillos con banda elástica para sujetar los cuchillos con seguridad.

Pockets with elastic band to hold knives securely.

Asa de mano + tira ajustable para colgar para un transporte más práctico.

Hand grip handle + adjustable hanging strap for convenient carrying.

Bolsa Porta Cuchillos
Knife roll
Sac porte-couteaux
Borsa portacoltelli
Tragebeutel für messer

REF.	L(mm)	W(mm)	H(mm)	€	UE / MOQ
11035	520	60	200		1-0-10-0-0/1



NEW

Funda Protectora Abs
Abs protective sheath
Étui de protection abs
Custodia protettiva In plastica
Schutzhülle abs

REF.	MEDIDAS / SIZES	€	UE / MOQ
11734	120 x 35 mm		1-30-240-0-0 /1
11735	160 x 35 mm		1-30-240-0-0 /1
11736	200 x 55 mm		1-30-240-0-0 /1
11737	240 x 65 mm		1-30-240-0-0 /1
11738	270 x 55 mm		1-30-240-0-0 /1

Tejido de Nylon resistente que protege los cuchillos de golpes y evita pinchazos y cortes.

Durable nylon fabric protects knives from knocks and prevents punctures and cuts.

Incluye maletín con compartimentos específicos para utensilios de cocina.

Includes case with specific compartments for kitchen utensils.



NEW

Mochila chef con maletín portacuchillos
Chef backpack with knife holder case
Sac à dos de chef avec étui porte-couteaux
Zaino da chef con custodia portacoltelli
Kochrucksack mit Messerhalteretui

REF.	L(mm)	W(mm)	H(mm)	€	UE / MOQ
12022	320	140	460		1-0-6-0-0/1

NEW

Delantal cocina
Kitchen apron
Tablier de cuisine
Crembiule da cucina
Küchenschürze

REF.	L(mm)	€	UE / MOQ
12023	180		1-0-12-0-0 /1

Acero inoxidable AISI 420-4034

Stainless steel

HRc 56 Rockwell

Microdentada

Micro-Toothed

Forjada en caliente

Hot forged

Diseño ergonómico

Ergonomic design

Todo tipo de alimentos

All types of food



INOX STAINLESS STEEL 420

Tijera profesional 8"
Scissors prof. Inox 8"
Ciseaux prof. Acier 8"
Forbice prof. Acciaio 8"
Stahl prof Schere 8"

REF.	L(mm)	€	UE / MOQ
5164	200	83,65	1-0-6-84-588 / 1



INOX STAINLESS STEEL 420

Tijera cocina inox
Kitchen scissors
Ciseaux de cuisine
Forbici cucina
Küchenschere

REF.	L(mm)	€	UE / MOQ
3910	220		1-12-48-288-576 / 12



Cascañueces
Nut cracker
Case-noix
Rompinoci
Nussknacker



REF.	L(mm)	€	UE / MOQ
3623	160		1-10-50-900-2700 / 10

INOX STAINLESS STEEL 304



Tenedor marisco
Shellfish fork
Fourchette crustacé
Forchetta crostacei
Fischgabel

REF.	L(mm)	€	UE / MOQ
5099	220		0-12-120-3000-15K / 12



INOX STAINLESS STEEL 2Cr14

PP POLYPROPYLENE

Tijera para aves
Poultry shears
Coupe volailles
Trinciapollo
Geflügelschere

REF.	L(mm)	€	UE / MOQ
8989	200		1-6-36-216-432 / 6



INOX STAINLESS STEEL 3Cr13

NYLON

Tijera cocina 8,5
Kitchen scissors 8,5
Ciseaux cuisine 8,5
Forbice multiuso 8,5
Küchenschere 8,5

REF.	L(mm)	€	UE / MOQ
8988	210		1-12-96-576-576 / 12



Pinza rompe marisco
Lobster cracker
Pince homard
Pinza per aragosta
Hummerkuacker



REF.	L(mm)	€	UE / MOQ
0738	190		1-5-50-350-1400 / 12



NEW

Pinza marisco
Shellfish cracker
Pince à fruits de mer
Pinza per frutti di mare
Schalentier-pinzette



REF.	L(mm)	€	UE / MOQ
11827	190		1-12-96 / 1



INOX STAINLESS STEEL 420

Tijera master 8"
Scissors master inox 8"
Ciseaux master acier 8"
Forbice master acciaio 8"
Stahl Maister Schere 8"

REF.	L(mm)	€	UE / MOQ
5165	200		1-0-6-84-588 / 1





Regulador de grueso del corte.

Cutting thickness regulator.

Soporte para sujeción de verduras y frutas con protección para los dedos.

Vegetable and fruit holder with finger protection.

Pies plegables y antideslizantes.

Foldable, non-slip feet.

INOX STAINLESS STEEL 420

CUCHILLA / BLADE:
RODAJAS

CUCHILLA / BLADE:
JULIANA 4MM

CUCHILLA / BLADE:
JULIANA 6MM

CUCHILLA / BLADE:
JULIANA 10MM

CUCHILLA / BLADE:
GOFRADO



NEW

Mandolina Inox
Stainless Steel Mandoline
Mandoline Inox
Mandolina Inox
Edelstahl Mandoline



PACKAGING BOX

REF.	L(mm)	W(mm)	H(mm)	€	UE / MOQ
11748	395	123	42		1-0-6-0-0 / 1



Corte / Ralladores profesionales
Cutting / Professional graters



Rallador WIDE extra fino
St. Steel "wide" grater extra-thin
Râpe en inox coupe ultra fine
Grattugia taglio superfine
Breit rostfreie Reibe extra fein



REF.	L HOJA	L TOTAL	€	UE / MOQ
8946	135	320		1-6-96-576-576 / 6

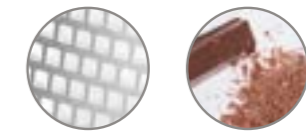

Rallador WIDE fino
St. Steel "wide" grater thin
Râpe en inox coupe fine
Grattugia taglio fine
Breit rostfreie Reibe fein



REF.	L HOJA	L TOTAL	€	UE / MOQ
8947	135	320		1-6-96-0-576-576 / 6

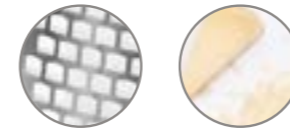

Rallador WIDE grueso
St. Steel "wide" grater extra coarse
Râpe en inox coupe épaisse
Grattugia taglio spesso
Breit rostfreie Reibe grob



REF.	L HOJA	L TOTAL	€	UE / MOQ
8948	135	320		1-6-96-576-576 / 6

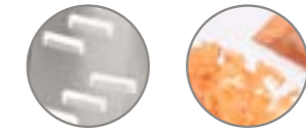

Rallador WIDE tiras largas
St. Steel "wide" grater large shaver
Râpe en inox coupe julienne
Grattugia taglio julienne
Breit rostfreie Reibe mit lange



REF.	L HOJA	L TOTAL	€	UE / MOQ
8949	135	320		1-6-96-768-768 / 6



Rallador SLIM fino
St. Steel lengthways grater thin
Râpe longue en inox coupe fine
Grattugia lunga taglio fine
Schmal rostfreie Reibe fein



REF.	L HOJA	L TOTAL	€	UE / MOQ
8950	220	410		1-6-96-576-576 / 6

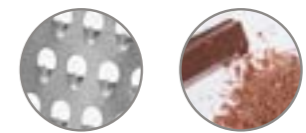

Rallador SLIM medio redondo
St. Steel lengthways grater medium
Râpe longue en inox coupe redondo moyen
Grattugia lunga taglio mezzo giro
Schmal rostfreie Reibe medium



REF.	L HOJA	L TOTAL	€	UE / MOQ
8951	220	410		1-6-96-576-576 / 6



Rallador SLIM grueso
St. Steel lengthways grater extra coarse
Râpe longue en inox coupe épaisse
Grattugia lunga taglio spesso
Schmal rostfreie Reibe grob



REF.	L HOJA	L TOTAL	€	UE / MOQ
8952	220	410		1-6-96-576-576 / 6

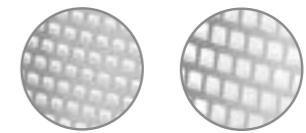

Rallador SLIM dual
St. Steel lengthways grater dual
Râpe longue en inox coupe dual
Grattugia lunga taglio dual
Duale schmal rostfreie Reibe



REF.	L HOJA	L TOTAL	€	UE / MOQ
8953	220	410		1-6-96-576-576 / 6

Se presenta con una funda de plástico para proteger la zona de corte

Comes with a plastic sheath to protect the cutting edge

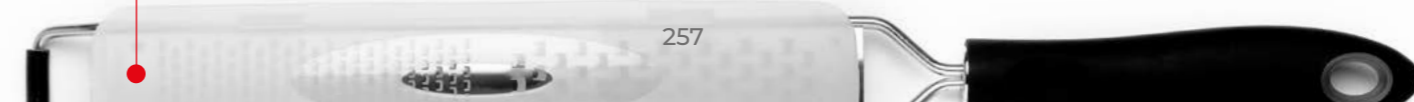

Mango ergonómico

Ergonomic handle

INOX
STAINLESS
STEEL
430

Acero inoxidable resistente al desgaste y la corrosión.

Wear and corrosion resistant stainless steel.

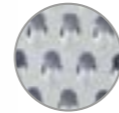

Grueso
Coarse

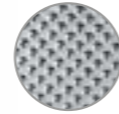

Fino
Fine

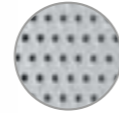

Medio
Medium



Rebanador
Slicer

Rallador 4 caras HQ

4 side grater HQ
Rape 4 cotés HQ
Grattugia 4 facce HQ
Vierkantreibe HQ

REF.	H(mm)	€	UE / MOQ
7448	240	7,32	1-12-72-288-288 / 6

INOX
STAINLESS
STEEL
201

Rallador 4 caras

4 side grater
Râpe 4 faces
Grattugia 4 lam.
Vierkantreibe

REF.	H(mm)	€	UE / MOQ
1150	210		1-0-60-720-2160 / 6



NEW

Abrelatas Inox

Stainless Steel Tin Opener
Ouvre-Boîte Inox
Apriscatole In Acciaio Inox
Dosenöffner Edelstahl



REF.	L(mm)	W(mm)	H(mm)	€	UE / MOQ
11818	65	45	28		1-0-96-0-0 / 1

INOX
STAINLESS
STEEL
430

Pelapatatas

Potato-peeler
Économe acier inox
Pelapatate
Kartoffelschäler



REF.	L(mm)	€	UE / MOQ
3455	110		1-12-12-36-72 / 12



Rasqueta plancha profesional 30cm

Professional scraper
Racleur professionnelle
Raschietti
Schaber glatt

REF.	L(mm)	€	UE / MOQ
8474	300		1-12-24-288-2016 / 12

Recambio 10 cuchillas

Blister 10 blades
Blister 10 lames
Blister 10 lame
Blister 10 messer



REF.	€	UE / MOQ
8507		1-50-100-1100-6600 / 10

Rodillo de recambio

Wheel (spare part)
Rouleau (pièce de rechange)
Rullo
Austauschrad

REF.	€	UE / MOQ
8566		1-0-200-3000-9000 / 1

Cuchilla de recambio

Knife (spare part)
Couteau (pièce de rechange)
Lame
Austauschklinge

REF.	€	UE / MOQ
8565		1-0-200-3000-9000 / 1



NEW

Cepillo

Scraper
Brosse À Gratter
Raschietto
Schaber

REF.	L(mm)	W(mm)	H(mm)	€	UE / MOQ
11946	470	125	55		1-0-6-0-0 / 1

Recambio Cepillo

Replacement Scraper Brush
Pièce De Recharge Brosse À Gratter
Ricambio Spazzola Raschietto
Ersatzbürste Schaber

REF.	L(mm)	W(mm)	H(mm)	€	UE / MOQ
11947	125	70	17		1-0-24-0-0 / 1



Abrelatas industrial

Can opener
Ouvre-boîtes professionnel
Apriscatole
Industrieller edelstahl dosenöffner

REF.	H(mm)	€	UE / MOQ
8564	600		1-0-8-16-16 / 1

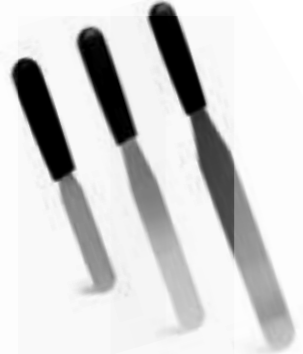

Espátula pastelera
Baker spatula
Palette
Spatola cuoco
Kuchenspachtel

REF.	SIZE	HOJA (mm)	€	UE / MOQ
8932	S	135		1-12-48-576-1152 / 12
8933	M	225		1-12-48-480-960 / 12
8934	L	300		1-12-48-432-864 / 12

Mango de polipropileno (PP) de forma redondeada para una sujeción más cómoda.

Rounded polypropylene (PP) handle for a more comfortable grip.

Piezas aptas para lavavajillas.

Dishwasher safe.

Alta resistencia a la corrosión.

Highly rust-resistant.

Pala fabricada en Acero inoxidable endurecido de alta calidad.

Spatula in high-quality hardened stainless steel.

Acabado satinado.

Satin finished.

Resistencia y flexibilidad para facilitar el trabajo en la cocina.

Hard-wearing and versatile round the kitchen.

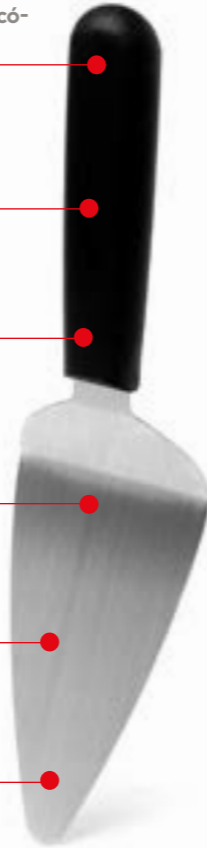

Paleta plancha triangular
Cleaning spatula
Palette triangle
Spatola triangolare
Dreieckige Bratenspachtel

REF.	SIZE	HOJA (mm)	€	UE / MOQ
8939	S	80		1-12-48-576-1152 / 12
8940	L	100		1-12-48-480-960 / 12



Espátula pescado
Fish Spatula
Spatule poisson
Pesce spatola
Fischpachtel

REF.	W (mm)	L (mm)	€	UE / MOQ
9996	80	290		1-12-48-384-768 / 1



Espátula plancha rectangular biselada mango madera
Spatula. Wood handle
Palette. Manche en bois
Spatola hamburger
Bratenwender mit Holzgriff

REF.	MODELO	W (mm)	L (mm)	€	UE / MOQ
8942	RECTANGULAR	80	290		1-12-48-384-768 / 12
8943	TRIANGULAR	80	235		1-12-48-384-1920 / 12



Pala repostería
Cake server
Pelle à gâteau
Spatola dolci
Kekss-Spachtel

REF.	W (mm)	€	UE / MOQ
8941	120	2,74	1-12-48-384-1152 / 12



Espátula pescado biselada
Fish turner
Palette poisson
Spatola pesce
Fischschaufel

REF.	W (mm)	H (mm)	€	UE / MOQ
8936	75	165		1-12-48-384-768 / 12



Espátula flexible acodada
Angular spatula
Palette coudée
Spatola cuoco con scalino
Winkelpalette

REF.	SIZE	HOJA (mm)	€	UE / MOQ
8938	S	140		1-12-48-384-768 / 12
8937	L	200		1-12-48-288-864 / 12



Espátula plancha rectangular biselada
Solid, beveled turner
Palette pleine, biseautée
Spatola hamburger
Bratenspachtel Rechtechige

REF.	W (mm)	H (mm)	€	UE / MOQ
8935	80	120		1-12-48-384-768 / 12



Espátula angular emplatado
Angular spatula
Mini spatule
Spatola
Kleine Winhelpalette

REF.	L Total (mm)	Paleta (mm)	€	UE / MOQ
8476	220	95		1-48-288-1728-5184 / 12



Mini lengua de silicona
Silicone spoon
Cuillère silicone
Spatola silicone
Silikonlöffel

REF.	L (mm)	COLOR	€	UE / MOQ
5161	170	ROJA		1-24-96-1920-5760 / 24





Punta estriada para un mejor agarre de los alimentos

Grooved tip for a better grip of the foods.

30 cm

24 cm
20 cm

21 cm

16 cm

Pinza chef recta
Straight chef tong
Pince chef droite
Pinze chef diritta
Pinzettenzange

INOX STAINLESS STEEL 430

Pinza chef precisión
Precision chef tong
Pince chef précision
Pinze chef precisione
Präzisions-Kochpinzette

INOX STAINLESS STEEL 430

REF.	L(mm)	€	UE / MOQ
7477	210		1-24-96-1920-5760 / 6
7478	300		1-24-96-1920-5760 / 6

REF.	L(mm)	€	UE / MOQ
7475	160		1-24-96-1920-5760 / 6
7476	240		1-24-96-1920-5760 / 6



Pinza chef curva
Curved chef tong
Pince chef courbée
Pinze chef curve
Gebogene Pinzette

INOX STAINLESS STEEL 430

REF.	L(mm)	COLOR	€	UE / MOQ
7473	145	INOX		1-24-96-1920-5760 / 6
7474	200	INOX		1-24-96-1920-5760 / 6
8680	200	ORO		1-24-96-1920-5760 / 6
8681	200	COBRE		1-24-96-1920-5760 / 6
8682	200	NEGRO		1-24-96-1920-5760 / 6



8682
8681
8680

OPCIÓN DE PERSONALIZACIÓN CON LASER.
LASER PERSONALISATION OPTION



INOX STAINLESS STEEL 430

INOX STAINLESS STEEL 430

Molde redondo
Round ring
Moulage rond
Teglia tondo
Runckle Kochringe

Molde cuadrado
Square ring
Moulage carre
Teglia quadrato
Quadratische Kochringe

REF.	Ø(mm)	H(mm)	€	UE / MOQ
7461	60	45		1-32-128-512-1536 / 12
7462	70	45		1-32-128-768-1536 / 12
7463	80	45		1-32-128-768-1536 / 12
7464	90	45		1-32-128-768-1536 / 12
7465	100	45		1-32-128-256-512 / 12
7466	120	45		1-32-128-256-512 / 12

REF.	W/L (mm)	H(mm)	€	UE / MOQ
7467	60x60	45		1-32-128-512-1536 / 12
7468	70x70	45		1-32-128-768-1536 / 12
7469	80x80	45		1-32-128-768-1536 / 12
7470	90x90	45		1-32-128-768-1536 / 12
7471	100x100	45		1-32-128-768-1536 / 12
7472	120x120	45		1-32-128-768-1536 / 12

REF.	SET	€	UE / MOQ
7449	PACK 6		1-24-48-192-392 / 6

REF.	SET	€	UE / MOQ
7450	PACK 6		1-24-48-192-392 / 6



Pinza chef quitaespinas
Fish bone chef tong
Pince chef à désarêter
Pinze lisca del pesce chef
Frischgräten küchenmeister zange

INOX STAINLESS STEEL 430

REF.	L(mm)	€	UE / MOQ
7479	120		1-24-96-1920-5760 / 6



Pinza quitaespinas
Fish bone tong
Pince à désarêter
Pinze lisca del pesce
Frischgräten pinzette

NEW INOX STAINLESS STEEL 430

REF.	L(mm)	W(mm)	H(mm)	€	UE / MOQ
11819	135	19	20		1-0-72 / 1



Mango con gancho para un fácil almacenamiento.

Hook handle for easy storage



Capacidad grabada en el mango.

Capacity engraved on the handle

Acabado brillo. Menos poroso, facilita la limpieza.

Mirror finish.. Less porous, easier to clean.

Mango más grueso con nervio central que le proporciona más rigidez y resistencia.

Thicker handle with a central rib for more rigidity and stiffens and strengthens the handle.

INOX STAINLESS STEEL 201

Espumadera con malla
Mesh skimmer
Écumoire maillée
Schiumarola a rete passabrodo
Draht Schaumlöffel

REF.	Ø(mm)	€	UE / MOQ
9735	140		1-0-50-120-450 / 10
9736	160		1-0-30-120-360 / 10
9737	180		1-0-30-120-360 / 10
9738	200		1-0-30-90-270 / 10
9739	240		1-0-30-90-270 / 10

INOX STAINLESS STEEL 430

Cazo Monoblock
One piece laddle
Louche monoblock
Mestolo monoblock
Schöpfhelle monoblock

REF.	Ø(mm)	L(mm)	ml	€	UE / MOQ
9712	65	300	70		1-10-240-720 / 10
9713	80	320	125		1-6-60-240-480 / 10
9714	90	330	200		1-10-40-160-480 / 10
9715	100	370	250		1-10-40-160-320 / 10
9716	120	430	430		1-10-40-160-320 / 10
9717	140	440	650		1-10-40-160-320 / 10
9718	160	470	950		1-10-20-40-160 / 10

INOX STAINLESS STEEL 201

Cuchara servir monoblock
One piece spoon
Coulliere monoblock
Cucchiaio monoblock
Servierlöffel

REF.	L(mm)	€	UE / MOQ
9726	330		1-10-60-120-480 / 10

INOX STAINLESS STEEL 201

Tenedor 2 púas monoblock
One piece meat fork
Fourchette monoblock
Forchetta monoblock
Fleischgabel monoblock

REF.	L(mm)	€	UE / MOQ
9728	520		1-20-60-300-1500 / 10

INOX STAINLESS STEEL 201

Araña
Tinned skimer
Escumoire etamée
Schiumarola filo
Fritierlöffel

REF.	Ø(mm)	€	UE / MOQ
9729	140		1-0-50-200-400 / 10
9730	160		1-0-25-100-200 / 10
9731	180		1-0-25-100-200 / 10
9732	200		1-0-25-100-200 / 10
9733	220		1-0-25-100-200 / 10
9734	240		1-0-25-100-200 / 10

INOX STAINLESS STEEL 201

Espumadera Monoblock
One piece skimmer
Écumoire monoblock
Schiumarola monoblock
Schäumerlöffel

REF.	Ø(mm)	L(mm)	€	UE / MOQ
9719	80	290		1-10-60-240-480 / 10
9720	100	320		1-10-60-240-720 / 10
9721	120	350		1-10-40-160-480 / 10
9722	140	380		1-10-40-160-480 / 10
9723	160	410		1-10-40-160-320 / 10
9724	180	430		1-10-40-80-240 / 10
9725	200	450		1-10-40-80-240 / 10

INOX STAINLESS STEEL 201

Espátula perforada
Perforated spatula
Spatule perforée
Spatola forata
Pfanneschaufel perforiert

REF.	L(mm)	€	UE / MOQ
9727	350		1-12-48-420-840 / 10



Nylon
Fibra de alta calidad.
Poca porosidad mayor du-
reza.

Nylon
High-quality fibres.
Non-porous, more hard-wea-
ring.

BPA FREE
BPA FREE

Alta resistencia térmica.
Soportan temperatura de
hasta 220°C

Strong heat-resistance.
For use in temperatures
up to 220 °C

No raya.
Suavidad con las superfi-
cies antiadherentes

Non-scratching.
Delicate on
non-stick surfaces

Gancho que permite colgar
para un práctico almacenaje.

*Hanging for convenient stor-
age.*



Muesca
antivuelco
No tipping

		L mm	Ø mm	ml	UE / MOQ
A	11809 CUCHARA NYLON Spoon, Cuillère, Cucchiaino, Löffel	49			1-0-75 / 1
B	11810 CUCARÓN NYLON 10 Spoon, Louche, Mestolo, Schöpflöffel	48	Ø 100	200ml	1-0-50 / 1
	11811 CUCARÓN NYLON 12 Spoon, Louche Mestolo, Schöpflöffel	50	Ø 120	350ml	1-0-75 / 1
	11812 CUCARÓN NYLON 14 Spoon, Louche, Mestolo, Schöpflöffel	51	Ø 140	500ml	1-0-50 / 1
C	11813 ESPÁTULA NYLON PERFORADA Slotted, Spatula, Spatule Perforé, Spatola Forata, Schanfel perforiert	51			1-0-75 / 1
D	11814 ESPÁTULA NYLON SIN AGUJEROS Spatula W/O, Spatule Sans Trou, Spatola Senza Buchi, Pfannenwender Ohne Löcher	51			1-0-75 / 1
E	11815 ESPUMADERA NYLON 10 Skimmer, Écumaire, Schiumarola, Schaumlöffel	44	Ø 100		1-0-75 / 1
	11816 ESPUMADERA NYLON 12 Skimmer, Écumaire, Schiumarola, Schaumlöffel	45	Ø 120		1-0-75 / 1
	11817 ESPUMADERA NYLON 14 Skimmer, Écumaire, Schiumarola, Schaumlöffel	47	Ø 140		1-0-75 / 1

		L mm	UE / MOQ
A	8405 CUCHARA SPAGUETTI Spaguetti server, Cuillère spaguetti, Servispaguetti, SpaguettiLöffel	325	1-0-12-120-480 / 12
B	8407 PINZA COCINA Kitchen pincers, pince, pinza cucina, zange	310	1-0-12-120-480 / 12
C	8398 CAZO Ladle, louche, mestolo, schöpföffel	330	1-0-24-120-480 / 12
D	8400 ESPÁTULA PERFORADA Slotted Spatula, Spatule Perforé, Spatola Forata, Pfannenwender Mit Schlitzen	345	1-0-12-120-480 / 12
E	8399 ESPUMADERA Skimmer Écumaire Schiumarola Schaumlöffel	335	1-0-12-120-480 / 12
F	8402 PALA LASAÑA Lasagna shovel, palette à lasagne, pala lasagna, lasagneheber	290	1-0-12-120-480 / 12
G	8404 PALA FREIR Lasagna shovel, palette à lasagne, pala lasagna, lasagneheber	290	1-0-12-120-480 / 12
H	8403 CUCHARA SERVIR Rice shovel, cuillère de service, cucchiaino riso, servierlöffel	285	1-0-12-120-480 / 12
I	8406 ESPÁTULA CREPES creppes spatula, palette, spatola creppes, kuchenheber	335	1-0-12-120-480 / 12
J	8401 PALETA PESCADO Universal shovel, pelle à poisson, pala multiuso, fischheber	335	1-0-12-120-480 / 12



Espátula madera
Solid turner
Spatule en bois
Spatola di legno
Holzspachtel



REF.	L(mm)	€	UE / MOQ
10717	330		1-12-72/12



Cuchara madera
Pointed spoon
Cuillère en bois
Cucchiaio di legno
Holzlöffel



REF.	L(mm)	€	UE / MOQ
10718	330		1-12-72/12



Barra de comandas
Order rack
Porte-fiches à billes
Asta portascontrini
Zettelfeiste



REF.	W(mm)	L(mm)	H(mm)	€	UE / MOQ
9760	24	615	24		1-6-24-168-672 / 6
11776	58	1000	22		1-0-24 / 1



Espolvoreador 3 posiciones
Stainless steel sprinkler 3p
Saupoudreuse acier 3p
Draga acciaio 3p
Strendose 3 pos.



REF.	H(mm)	€	UE / MOQ
8794	110		1-1-100-600-1200 / 1



Escurre fritos y carnes
Fry colander
Passoire à frites
Cesta per friggere
Frittensieb



REF.	W(mm)	L(mm)	€	UE / MOQ
8381	290	400		1-0-6-24-24 / 1
8382	390	500		1-0-4-12-24 / 1
8383	390	600		1-0-3-9-27 / 1

Biberón rojo
Red squeeze bottles
Distributeur
à pression rouge
Garrafa rosso
Dosierflasche rot



REF.	ml	H(mm)	€	UE / MOQ
8439	240	190		1-4-24-240-720 / 24
8440	360	220		1-4-24-192-960 / 24
8441	720	260		1-4-24-144-576 / 24

Biberón amarillo
Yellow squeeze bottles
Distributeur
à pression jaune
Garrafa giallo
Dosierflasche Gelb



REF.	ml	H(mm)	€	UE / MOQ
8442	240	190		1-4-24-240-720 / 24
8443	360	220		1-4-24-192-960 / 24
8444	720	260		1-4-24-144-720 / 24



Triple boquilla:
ideal para decoraciones.
Triple nozzle:
great for decorations.

Biberón triple
Triple squeeze bottle
Triple distributeur
Garrafa com boquilha triplo
Dosierflasche mit Dreifachdüse

REF.	ml	H(mm)	€	UE / MOQ
8449	360	180		1-4-24-192-960 / 24
8450	720	245		1-4-24-144-576 / 24



Todos los biberones
tienen marcas de medición
en milímetros.
All bottles
have measurement marks
in millimeters.

Biberón transparente
Clear squeeze bottles
Distributeur à pression transparent
Garrafa trasparente
Dosierflasche transparent

REF.	ml	H(mm)	€	UE / MOQ
8445	240	190		1-4-24-240-1200 / 24
8446	360	220		1-4-24-216-1080 / 24
8447	720	260		1-4-24-144-576 / 24
8448	1.000	310		1-4-24-96-384 / 24



INOX
STAINLESS
STEEL
201

Rustidera
Lasagna pan
Plat à rôtir
Rostiera
Lasagneform



REF.	W(mm)	L(mm)	H(mm)	€	UE / MOQ
1422	250	180	40		1-0-24-144-288 / 4
1421	300	220	50		1-0-12-72-144 / 4
1420	350	260	50		1-0-12-72-144 / 4
1419	400	300	60		1-0-12-72-144 / 4
5282	450	320	65		1-0-4-16-48 / 4
5283	500	360	70		1-0-4-16-32 / 4
5284	600	400	75		1-0-4-16-16 / 4

INOX
STAINLESS
STEEL
201

Pinza para rustidera
Lasagna pan tong
Pince plat à rôtir
Molla forno
Ofenzange



REF.	L(mm)	€	UE / MOQ
5656	185		1-10-100-600-1800 / 6

INOX
STAINLESS
STEEL
304

Harinero
Flour bin
Tamis à farine inox
Farinheiro
Mehlsieb

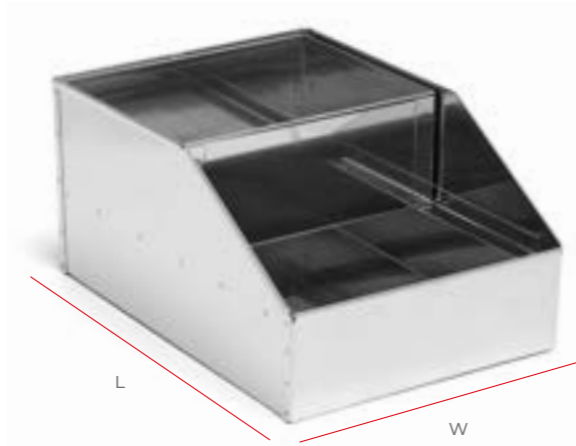

REF.	W(mm)	L(mm)	H(mm)	€	UE / MOQ
8384	265	370	180		1-0-1-8-24 / 1
8385	265	500	180		1-0-1-6-18 / 1
8386	330	500	180		1-0-1-4-12 / 1

NEW

INOX
STAINLESS
STEEL
201

Colador Chino Piston
Piston Funnel
Passoire Chinois Piston
Colino Chinese A Pistone
Passiersieb



REF.	L (mm)	W(mm)	H(mm)	€	UE / MOQ
11777	280	200	240		1-0-8-0-0 / 1

INOX
STAINLESS
STEEL
201

Colador chino con clip
Conical soup strainer with clip
Passoire chinois
Cornetto cinese
Spitzsieb



REF.	Ø(mm)	€	UE / MOQ
9764	160		1-0-60-240-480 / 10
9765	180		1-0-60-240-480 / 10
9766	200		1-0-60-240-480 / 10
9767	220		1-0-60-240-480 / 10
9768	240		1-0-30-120-240 / 10
9769	260		1-0-30-120-240 / 10

NEW

INOX
STAINLESS
STEEL
201

Colador Malla
Mesh Sieve
Passoire Maille
Colino A Maglia
Küchensieb



REF.	Ø(mm)	H(mm)	€	UE / MOQ
11950	200	220		1-0-6-0-0 / 1
11949	250	270		1-0-6-0-0 / 1

INOX
STAINLESS
STEEL
201

Colador fino
Oil strainer
Passoire à huile
Colino per l'olio
Ölsieb

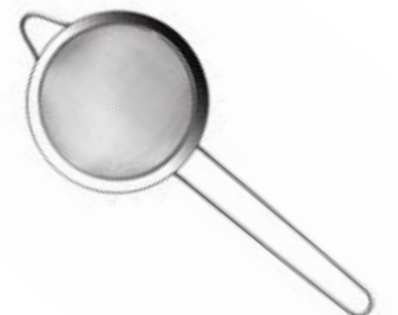

REF.	Ø(mm)	€	UE / MOQ
2884	80		1-0-24-960-1920 / 6
2885	100		1-0-24-960-1920 / 6
2886	120		1-0-24-960-1920 / 6
2887	140		1-0-24-960-1920 / 6
2888	160		1-0-24-960-1920 / 6
2889	180		1-0-24-960-1920 / 6
2890	200		1-0-24-960-1920 / 6

INOX
STAINLESS
STEEL
304

Cedazo Velo

Sieve velo
Tamis velo
Setaccio velo
Mehlsieb

REF.	Ø(mm)	€	UE / MOQ
10650	250		1-6-12-96-192 / 1
10651	300		1-6-12-36-108 / 1
10652	350		1-4-8-48-96 / 1



MEDIDA MALLA / MESH SIZE:
1,5 x 1 mm

INOX
STAINLESS
STEEL
304

Cedazo Harina

Flour sieve
Tamis farine
Setacciofarina
Mehlsieb

REF.	Ø(mm)	€	UE / MOQ
10653	250		1-6-12-96-192 / 1
10654	300		1-6-12-72-144 / 1
10655	350		1-4-8-48-96 / 1

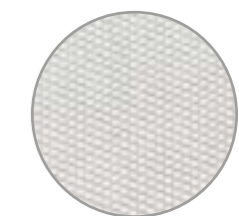

MEDIDA MALLA / MESH SIZE:
2,5 x 1,4 mm

INOX
STAINLESS
STEEL
304

Cedazo Pan

Bread Sieve
Tamis pain
Setaccio pane
Brotsieb

REF.	Ø(mm)	€	UE / MOQ
10656	300		1-6-12-36-108 / 1
10657	350		1-4-8-48-96 / 1

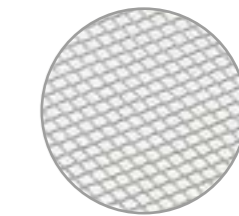

MEDIDA MALLA / MESH SIZE:
4 x 3 mm

INOX
STAINLESS
STEEL
304

Cedazo Pescado

Fish sieve
Tamis poisson
Setaccio peixe
Fischsieb

REF.	Ø(mm)	€	UE / MOQ
10658	300		1-6-12-36-108 / 1
10659	350		1-4-8-48-96 / 1

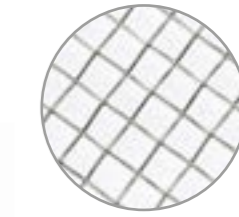

MEDIDA MALLA / MESH SIZE:
11 x 9 mm

INOX
STAINLESS
STEEL
430

Barillas de acero inoxidable de alta resistencia.

Tough stainless steel bars.

NYLON

Mango de nylon de forma ergonómica. Con relieves para mejorar el agarre.

Ergonomic nylon handle. Raised pattern for better grip.

Fácil almacenaje.

Easy to store.



Batidor 8 varillas Nylon

Whisk 8 wires
Fouet 8 fils
Frusta 8 fili
Rührbesen 8 Drähte

REF.	L (mm)	VARILLAS (mm)	€	UE / MOQ
8480	250	12		1-12-48-380-1920 / 12
8481	300	170		1-12-48-288-864 / 12
8482	350	220		1-12-48-284-864 / 12
8483	400	250		1-6-24-120-600 / 6



INOX
STAINLESS
STEEL
201

Batidor 8 varillas

Whisk 8 wires
Fouet 8 fils
Frusta 8 fili
Rührbesen 8 Drähte

REF.	L (mm)	VARILLAS (mm)	€	UE / MOQ
9740	250	12		1-0-30-360-720 / 10
9741	300	170		1-0-30-270-540 / 10
9742	350	220		1-0-30-240-480 / 10
9743	400	250		1-0-30-180-360 / 10
9744	450	290		1-0-30-120-240 / 10
9745	500	370		1-0-30-120-240 / 10



Cuchara silicona

Silicon spoon
Cuillère silicone
Cucchiaio silicone
Silikonlöffel

SILICONE
MÁX. 230°C

REF.	L (mm)	€	UE / MOQ
8484	250		1-12-7-108-6048 / 12
8485	350		1-12-72-648-2592 / 12
8486	400		1-12-72-576-2304 / 12



Espátula silicona

Silicon spatula
Spatule silicone
Spatola silicone
Silikonspachtel

SILICONE
MÁX. 230°C

REF.	L (mm)	€	UE / MOQ
8487	250		1-12-72-1296-7776 / 12
8488	350		1-12-72-792-3168 / 12
8489	400		1-12-72-720-2880 / 12

PP
POLYPRO-
PYLENE

Jarra medidora

Measuring PP jug
Pichet gradué PP
Caraffa graduata
Messbecher



REF.	ml	H(mm)	€	UE / MOQ
8451	500	133		1-12-72-360-1080 / 12
8452	1.000	160		1-6-60-180-540 / 6
8453	2.000	215		1-6-60-180-180 / 6



PASTELERÍA
PASTRY
PP
POLYPRO-
PYLENE

Espátula pastelera

Small baker spatula
Palette
Spatola cuoco
Kuchenspachtel

REF.	SIZE	HOJA (mm)	€	UE / MOQ
8932	s	135		1-12-48-576-152 / 12
8933	M	225		1-12-48-480-960 / 12
8934	L	300		1-12-48-432-864 / 12

INOX
STAINLESS
STEEL
201

Bol semiesférico

Mixing bowl
Bassine hémisphérique
Bastardella semisferica
Schnees Schlagkessel



REF.	Ø(mm)	€	UE / MOQ
9748	160		1-0-100-1000-3000 / 10
9749	220		1-0-50-600-1200 / 10
9750	240		1-0-50-600-1800 / 10
9751	300		1-0-50-300-600 / 10
9752	340		1-0-25-150-450 / 5
9753	360		1-0-25-150-450 / 5
9754	400		1-0-25-150-300 / 5

INOX
STAINLESS
STEEL
201

Flanera profesional

Pudding mould
Moule à flan
Crème caramel
Becherförmchen



REF.	Ø(mm)	H(mm)	€	UE / MOQ
9632	75	50		1-12-120-960-3840 / 12
9633	85	55		1-12-120-960-3840 / 12



COLECCIÓN SARTENES / FRY PANS COLLECTION

/ ETNA / TEIDE / VULCANO / CROSCAT / AUVERNIA / USSON / VESUVIO / FUJI



	SARTÉN FRY PAN	ALUMINIO ALUMINIUM	ALUMINIO ALUMINIUM	ALUMINIO ALUMINIUM	ALUMINIO ALUMINIUM	ALUMINIO ALUMINIUM	ALUMINIO ALUMINIUM	INOX	INOX
	MANGO HANDLE	INOX	INOX	INOX	INOX	HIERRO IRON	HIERRO IRON	INOX	INOX
	ANTIADHERENTE NON-STICK								
	VITRO	●	●	●	●	●	●	●	●
	ELÉCTRICO ELECTRIC	●	●	●	●	●	●	●	●
	GAS	●	●	●	●	●	●	●	●
	INDUCCIÓN INDUCTION		●		●		●	●	●
	HORNO OVEN	●	●	●	●				
	APTO CONTACTO ALIMENTARIO FOODCONTACT SAFE								

COLECCIÓN BATERIA / COOKWARE COLLECTION

CROSCAT



	CUERPO BODY		ASAS HANDLES		ANTIADHERENTE NON-STICK		VITRO		ELÉCTRICO ELECTRIC		GAS		INDUCCIÓN INDUCTION		HORNO OVEN		APTO CONTACTO ALIMENTARIO FOODCONTACT SAFE
--	----------------	--	-----------------	--	----------------------------	--	-------	--	-----------------------	--	-----	--	------------------------	--	---------------	--	--



Doble capa antiadherente de alta calidad.

High quality double non-stick coating.

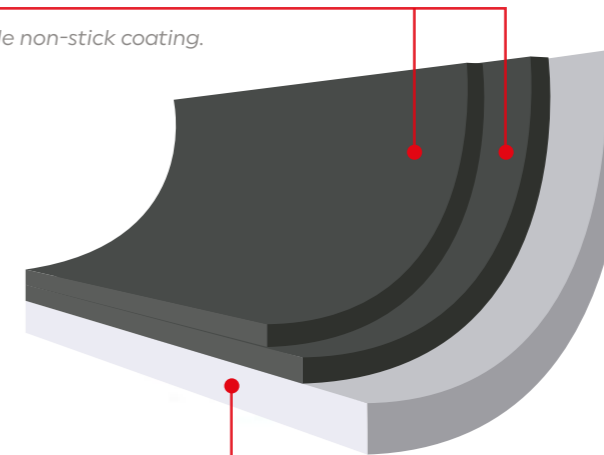

Aluminio de 3mm de espesor

3mm thick aluminium



Recomendamos el uso de utensilios de nylon para alargar la vida del recubrimiento antiadherente en perfectas condiciones.

We recommend the use of nylon utensils to extend the life of the non-stick coating in perfect condition.

Revestimiento antiadherente de fluororesina de grado universal de PFLUON con sistemas de revestimiento de dos capas. Esta serie de revestimientos es densa, antiadherente y fácil de limpiar.

PFLUON trabaja con el instituto de certificación de renombre mundial SGS para garantizar que los productos y servicios cumplen las normas mundiales y la normativa local. Podemos demostrarle que el antiadherente COOKMARK cumple las normas y especificaciones nacionales e internacionales.

PFLUON universal grade fluororesin non-stick coating with two-layer coating systems. This coating series is dense, non-stick and easy to clean.

PFLUON works with the world-renowned certification institute SGS to ensure that products and services meet global standards and local regulations. We can prove that COOKMARK non-stick coating meets national and international standards and specifications.



Sartenes diseñadas para resistir los servicios más exigentes.

Mango hermético.

Sealed handle.

Mango fabricado en acero inoxidable de forma tubular para facilitar la sujeción de la sartén.

Tubular stainless steel handle for easy handling.

Remachado al cuerpo de la sartén para proporcionar una sujeción superior y una máxima seguridad en el momento de su uso.

Riveted to the pan for strength and safety in use.

Eficiencia de la distribución calórica: Su cuerpo de aluminio de alta calidad capta y distribuye de la mejor manera el calor por toda la superficie.

Efficient conduction of heat: The high-quality aluminium body captures and conducts heat across the whole surface.

Recubrimiento totalmente libre de PFOA.

Coating totally PFOA-free.



4mm de grosor en tamaños grandes.
4mm thickness in large sizes.



Fondo de inducción. Difusión rápida y uniforme del calor.
Induction base. Rapid, uniform distribution of heat.



SARTÉN HONDA DEEP PAN

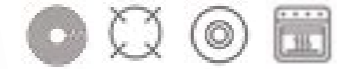

ETNA

Sartén aluminio mango inox

Aluminium fry pan with inox handle
Poêle aluminium manche en inox
Padella in alluminio manico in inox
Bratpfanne aluminium mit inoxgriff

REF.	Ø(mm)	e(mm)	€	UE / MOQ
8342	180	2,5		1-0-6-54-324 / 12
8343	200	3,5		1-0-6-36-324 / 12
8344	220	3,5		1-0-6-30-240 / 12
8345	240	3,5		1-0-6-24-216 / 6
8346	260	4		1-0-6-24-216 / 6
8347	280	4		1-0-6-24-192 / 6
8348	320	4		1-0-6-12-96 / 6
8349	360	4		1-0-6-12-84 / 6
8350	400	4		1-0-6-12-96 / 6



TEIDE

Sartén aluminio mango inox / Inducción

Aluminium induction fry pan with inox handle
Poêle induction aluminium manche en inox
Padella induzione in alluminio manico in inox
Bratpfanne aluminium mit inoxgriff induktion

REF.	Ø(mm)	e(mm)	€	UE / MOQ
8954	200	3		1-0-6-36-324 / 6
8955	240	3		1-0-6-24-216 / 6
8956	280	3		1-0-6-24-192 / 6
8957	320	3		1-0-6-12-96 / 6
11778	360	3		1-0-6-12-84 / 6
11996	400	3		1-0-6-12-96 / 6



VULCANO

Sartén aluminio antiadherente alta mango inox

Deep frypan, non stick coating
Poêle avec revêtement anti-adhésif
Padella inox antiaderente
Bratpfanne Aluminium mit inoxgriff

REF.	Ø(mm)	e(mm)	H(mm)	€	UE / MOQ
9971	200	3	55		1-0-6-36-288 / 6
9972	240	3	60		1-0-6-24-192 / 6
9973	280	3	65		1-0-6-24-144 / 6
9974	320	3	75		1-0-6-0-0 / 6
9975	360	3	80		1-0-6-0-0 / 6
9976	400	3	85		1-0-6-0-0 / 6

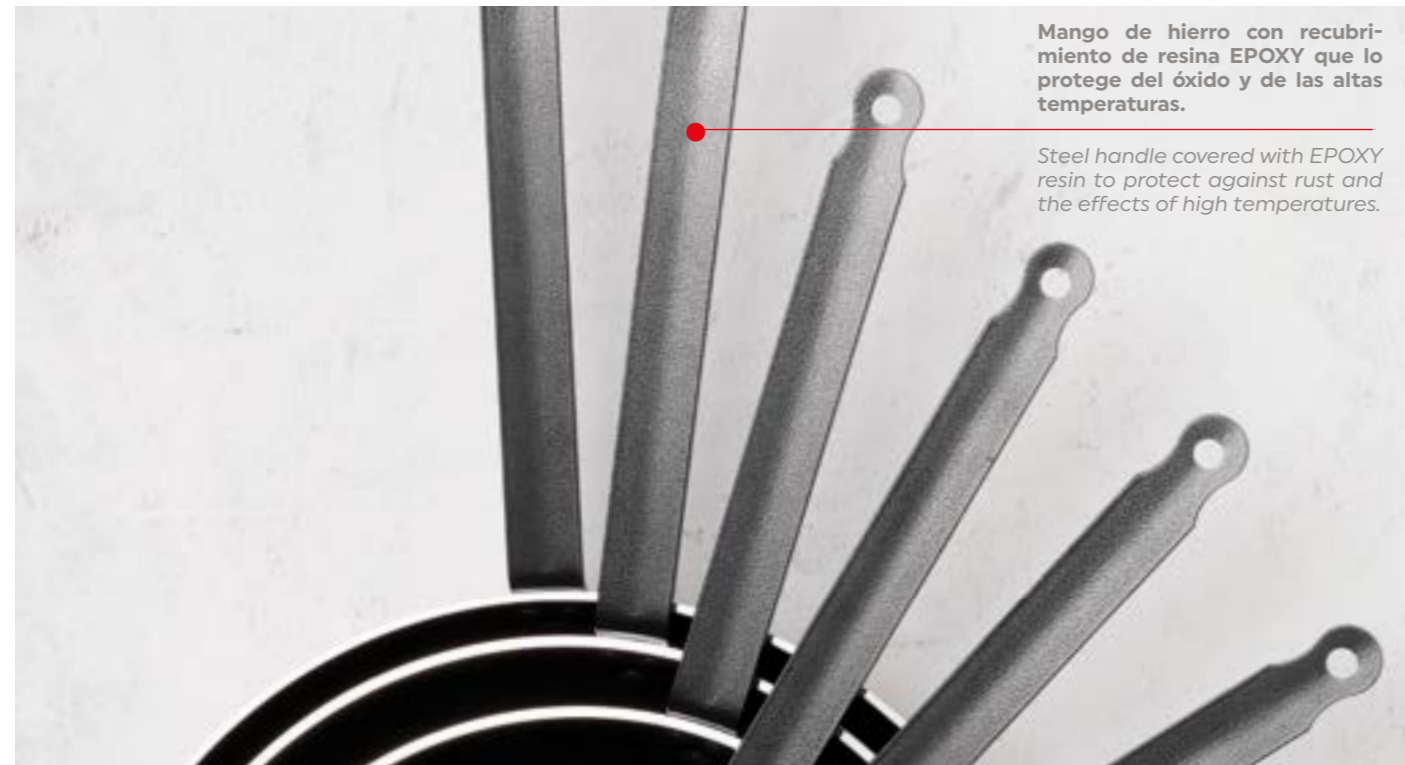

Mango de hierro con recubrimiento de resina EPOXY que lo protege del óxido y de las altas temperaturas.

Steel handle covered with EPOXY resin to protect against rust and the effects of high temperatures.

CAPAS EXTERIORES
ACERO INOXIDABLE
SUPERIOR
Mezcla cromo, titanio y cobre.

EXTERIOR LAYERS
SUPERIOR STAINLESS
STEEL
Mixing chrome, titanium and copper.



CAPA INTERIOR
ALUMINIO
INTERIOR LAYER
ALUMINIUM

BASE SANDWICH SYSTEM



- Alta resistencia a la corrosión y los ácidos alimentarios.
Highly resistant to rust and food acids.
- Menos porosidad, más higiénico.
Less porous, more hygienic surface.
- Óptima difusión del calor por toda la superficie.
Optimum heat distribution across the whole base.
- Muy resistente a las altas temperaturas y al desgaste.
Hard-wearing and tolerant of high temperatures.
- Apta para inducción.
Suitable for induction.



4mm de grosor en tamaños grandes.
4mm thickness in large sizes.



AUVERNIA

Sartén aluminio mango hierro
Aluminium fry pan with iron handle
Poêle aluminium manche en fer
Padella in alluminio manico in ferro
Aluminium-Bratpfanne mit Eisengriff

REF.	Ø(mm)	e(mm)	€	UE / MOQ
8351	180	2,5		1-0-6-54-324 / 12
8352	200	3,5		1-0-6-36-324 / 12
8353	220	3,5		1-0-6-30-240 / 12
8354	240	3,5		1-0-6-24-216 / 6
8355	260	4		1-0-6-24-216 / 6
8356	280	4		1-0-6-24-192 / 6
8357	320	4		1-0-6-12-96 / 6
8358	360	4		1-0-6-12-84 / 6
8359	400	4		1-0-6-12-96 / 6

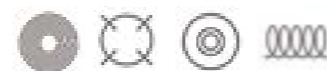

USSON

Sartén aluminio mango hierro / Inducción
Aluminium induction fry pan with inox handle
Poêle induction aluminium manche en inox
Padella induzione in alluminio manico in inox
Induktion aluminium-Bratpfanne mit inoxgriff induktion

REF.	Ø(mm)	e(mm)	€	UE / MOQ
8958	200	3		1-0-6-36-324 / 6
8959	240	3		1-0-6-24-216 / 6
8960	280	3		1-0-6-24-192 / 6
8961	320	3		1-0-6-12-96 / 6



Fondo de inducción. Difusión rápida y uniforme del calor.
Induction base. Rapid, uniform distribution of heat.



Base sistema SANDWICH
SADWICH system base



Asa adicional en diámetros grandes.
Additional handle on large diameters.

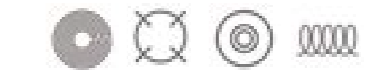

FUJI

Sartén inox mango inox
Frypan inox
Poêle à frire inox
Padella inox
Inox-Bratpfanne

REF.	Ø(mm)	e(mm)	€	UE / MOQ
8515	200	0,7		1-0-6-36-288 / 1
8516	240	0,7		1-0-6-24-192 / 1
8517	280	0,7		1-0-6-24-192 / 1
* 8518	320	1		1-0-4-8-64 / 1
* 8519	360	1		1-0-4-4-24 / 1
* 8520	400	1		1-0-4-4-28 / 1



VESUVIO

Sartén inox antiadherente mango inox
Frypan, non stick coating
Poêle avec revêtement anti-adhésif
Padella inox antiaderente
Bratpfanne mit Antihftbeschichtung

REF.	Ø(mm)	e(mm)	€	UE / MOQ
8509	200	0,7		1-0-6-36-288 / 1
8510	240	0,7		1-0-6-24-192 / 1
8511	280	0,7		1-0-6-24-144 / 1
* 8512	320	1		1-0-4-8-64 / 1
* 8513	360	1		1-0-4-4-28 / 1
* 8514	400	1		1-0-4-4-28 / 1

Nuestra colección CROSCAT está diseñada para satisfacer las exigencias de la cocina profesional, con una batería de servicio que incluye todas las piezas esenciales para la preparación de recetas perfectas.

Our CROSCAT collection is designed to meet the demands of the professional kitchen, with a service set that includes all the essential pieces for the preparation of perfect recipes.

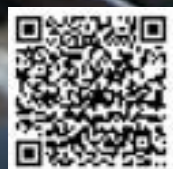

**Descubre la
gama de bate-
rías y sartenes.**



SARTÉN
HONDA
DEEP
PAN

Asa adicional en diámetros grandes.
Additional handle on large diameters.

Sartén aluminio antiadherente alta mango inox
Deep frypan, non stick coating
Poêle avec revêtement anti-adhésif
Padella inox antiaderente
Bratpfanne mit antihaftbes

REF.	Ø(mm)	e(mm)	H(mm)	€	UE / MOQ
10897	240	3	70		1-0-6-24-144 / 6
10898	280	3	75		1-0-6-24-144 / 6
10899	320	3	80		1-0-6-18-108 / 6
NEW 11599	360	3	80		1-0-4-0-0 / 4 *
NEW 11601	400	3	90		1-0-4-0-0 / 4 *

Cazuela aluminio
Aluminium casserole
Casserole aluminium
Casseruola in alluminio
Aluminiumkasserolle

REF.	Ø(mm)	e(mm)	H(mm)	€	UE / MOQ
11611	280	3	70		1-0-6-24-144 / 6
11612	320	3	80		1-0-6-18-108 / 6
11613	360	3	80		1-0-4-0-0 / 4
11615	400	3	90		1-0-4-0-0 / 4



NEW

Cazo Recto
Straight Ladle
Casserole Droite
Mestolo Dritto
Stieltopf

REF.	Ø(mm)	e(mm)	H(mm)	LITROS	€	UE / MOQ
11789	140	3	68	0,95		1-0-6-0-0 / 6
11790	160	3	76	1,4		1-0-6-0-0 / 6
11791	180	3	85	2		1-0-6-0-0 / 6
11792	200	3	98	2,88		1-0-6-0-0 / 6



NEW

Olla
Saucepan
Casserole
Pentola
Topf

REF.	Ø(mm)	e(mm)	H(mm)	LITROS	€	UE / MOQ
11780	200	3	140	4,18		1-0-4-0-0 / 4
11781	240	3	150	6,46		1-0-4-0-0 / 4
11782	280	3	170	9,98		1-0-4-0-0 / 4
11951	300	3	180	12,22		1-0-4-0-0 / 4
11952	320	3	185	14,32		1-0-4-0-0 / 4



NEW

Cacerola
Casserole
Fait-Tout
Casseruola
Stielkasserolle

REF.	Ø(mm)	e(mm)	H(mm)	LITROS	€	UE / MOQ
11787	240	3	100	4,25		1-0-4-0-0 / 4
11788	280	3	110	6,27		1-0-4-0-0 / 4
11953	300	3	120	8		1-0-4-0-0 / 4



NEW

Tapa Borosilicato
Borosilicate Lid
Couvercle Borosilicate
Coperchio In Vetro Borosilicato
Deckel Borosilikat Glasdeckel

REF.	Ø(mm)	€	UE / MOQ
11794	200		1-0-12-0-0 / 12
11795	240		1-0-12-0-0 / 12
11796	280		1-0-12-0-0 / 12
11954	300		1-0-12-0-0 / 12
11955	320		1-0-12-0-0 / 12



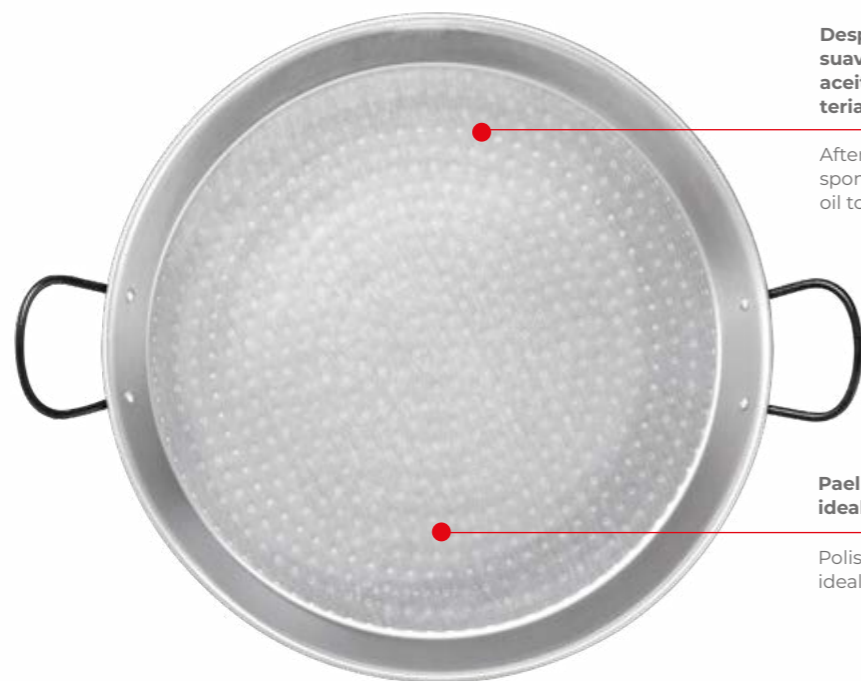

Después de usar lavar con esponja suave, secar y aplicar una capa de aceite de oliva para conservar el material.

After use, wash with a non-abrasive sponge, dry and apply a coat of olive oil to protect the material.

Paellera de acero pulido ideal para cocción de llama.

Polished steel paella pan, ideal for use over flame.



Paellera de acero con recubrimiento de esmalte que le proporciona una mayor resistencia al óxido.

Rust-resistant enamelled steel paella pan.

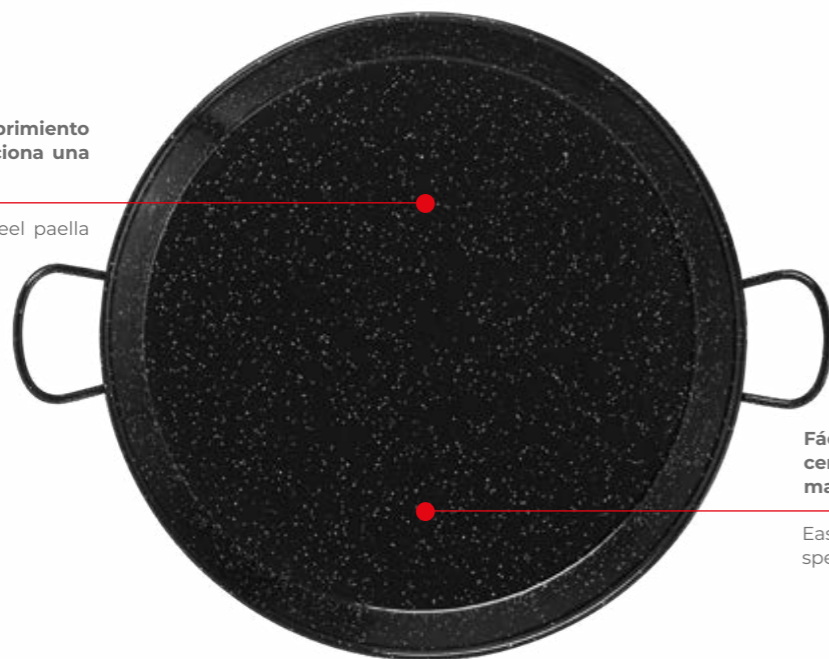

Fácil de limpiar y de almacenar, no precisan de un mantenimiento específico.

Easy to clean and store, no special care is required.





EL SALER

Paellera acero pulido
Polished steel spanish paella pan
Plat à paella tole acier
Padella valenciana lucida
Paellapfanne aus poliertem Stahl

REF.	Ø(cm)	Raciones	€	UE / MOQ
8964	30	4		1-0-6-24-144 /1
8965	34	6		1-0-6-24-120 /1
8966	38	8		1-0-6-12-60 /1
8967	42	10		1-0-6-12-60 /1
8968	46	12		1-0-4-8-48 /1
8969	50	13		1-0-4-8-48 /1
8970	60	20		1-0-4-4-24 /1
10937	65	25		1-0-0-0-0 /1
10938	70	30		1-0-0-0-0 /1
10939	80	40		1-0-0-0-0 /1
10940	90	50		1-0-0-0-0 /1

Paellera grande acero pulido
Polished steel spanish paella pan
Plat à paella tole acier
Padella valenciana lucida
Paellapfanne aus poliertem Stahl



REF.	Ø(cm)	Raciones	€	UE / MOQ
10941	100	85		1-0-0-0-0 /1
10942	115	120		1-0-0-0-0 /1
10943	130	200		1-0-0-0-0 /1

COMPATIBLE CON
COMPATIBLE WITH:
REF.: 10944 (p.314)



RIBA ROJA

Paellera acero esmaltado
Enamelled steel paella pan
Plat à paella acier émaillé
Padella valenciana smaltata
Paellapfanne aus emailliertem Stahl

REF.	Ø(cm)	Raciones	€	UE / MOQ
8971	30	4		1-0-6-24-144 /1
8972	34	6		1-0-6-24-120 /1
8973	38	8		1-0-6-12-60 /1
8974	42	10		1-0-6-12-60 /1
8975	46	12		1-0-4-8-48 /1
8976	50	13		1-0-4-8-48 /1
8977	60	20		1-0-4-4-24 /1

ALBUFERA

Sartén honda acero esmaltado
Deep enamelled fry pan with handles.
Poele haute avec anses.
Padella smaltata con manici.
Tiefe Paellapfanne aus emailliertem Stahl mit Griffen.

REF.	Ø(cm)	€	UE / MOQ
8978	28		1-0-6-24-120 /1
8979	32		1-0-6-24-120 /1
8980	36		1-0-4-8-40 /1
8981	40		1-0-4-8-40 /1
8982	45		1-0-3-6-30 /1
8983	50		1-0-3-6-30 /1

* También para raciones individuales.
Also for individual portions.
COLECCIÓN PELTRE (p.405)



Tripode regulable para quemador
Base for burner
Pied pour bruleur
Treppiede padella
Dreifusständer für Gasbrenner

REF.	W(cm)	H(cm)	€	UE / MOQ
8984	300	300		1-0-1-3-9 /1



Paravientos 3 piezas
Windshield
Pare-bris 3 pieces
Paravento 3 pezzi
Windschutzblech

REF.	W(cm)	H(cm)	€	UE / MOQ
8505	670	160		1-0-1-6-96 /1



Quegador paellero a gas
Enamelled gas burner
Brulleur émaillé
Bruciatore smaltato padella
Emaillierter Gasbrenner



REF.	Ø(cm)	PARA PAELLERAS:	€	UE / MOQ
8985	30	36 - 42CM		1-0-1-4-24 /1
8986	40	26 - 60CM		1-0-1-3-12 /1
8987	50	36 - 70CM		1-0-1-2-10 /1

Quegador de cocción para uso doméstico y/o profesional. Fabricado en acero y recubierto de una capa de esmalte. Diseñado para ser utilizado en el exterior.

Burner for domestic or professional use. Made of enamelled steel. Designed for outdoor use.



Este producto está certificado según la normativa de gas vigente. Conexión roscada especial para Gas Natural.

También disponible bajo demanda para otras conexiones europeas.

This product has been certified under the law relating to gas appliances. Threaded Natural Gas connector.

Available on request to fit other European connectors.



Quegador paellero a gas grande
Enamelled gas burner
Brulleur émaillé
Bruciatore smaltato padella
Emaillierter Gasbrenner

REF.	Ø(cm)	€	UE / MOQ
10944	90		1-0-0-0-0 /1



* Trípode incluido.
Funciona con 2 botellas de butano o propano.

Tripod included.
Works with 2 butane or propane bottles.

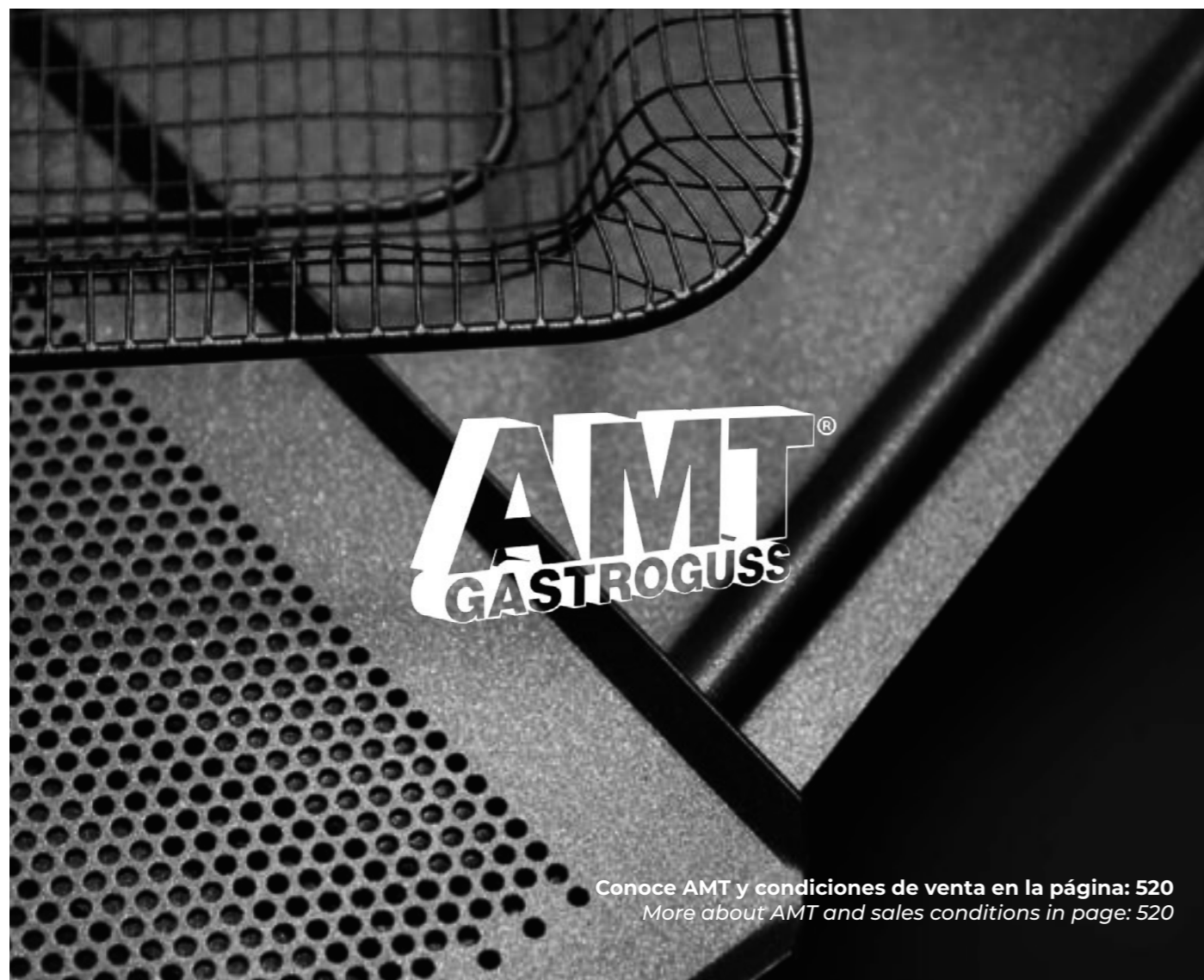

Conoce AMT y condiciones de venta en la página: 520
More about AMT and sales conditions in page: 520

Aluminio Fundido. Cast Aluminium.

Aluminio fundido de alta resistencia hecha por expertos artesanos. Gracias al espesor del aluminio, de los utensilios AMT almacenan más energía y mantiene la temperatura constante durante más tiempo.

Son resistentes a altas temperaturas sin ninguna alteración en su forma.

High-strength cast aluminium made by skilled craftsmen. Thanks to the thickness of the aluminium, AMT cookware stores more energy and maintains a constant temperature for longer.

They are resistant to high temperatures without any alteration in their shape.

Sostenibilidad. Sustainability.

AMT produce de una manera sostenible y respetuosa con el medio ambiente, proporcionando una selección consciente de los productos que va a utilizar durante mucho tiempo, al tiempo que **reduce significativamente su huella de carbono**.

El grosor de 9-10 mm del fondo de las sartenes y ollas garantiza una **gran transferencia de energía y retención del calor**. Esto nos permite aplicar cocciones de una manera más eficiente.

*AMT produced in a sustainable and environmentally friendly manner, providing a conscious selection of products that you will use for a long time, while **significantly reducing your carbon footprint**.*

*9-10 mm thick bottom of our pans and pots **ensures great energy transfer and heat retention**. This allows us to apply firings more efficiently.*

Superficie antiadherente. Non-stick surface.

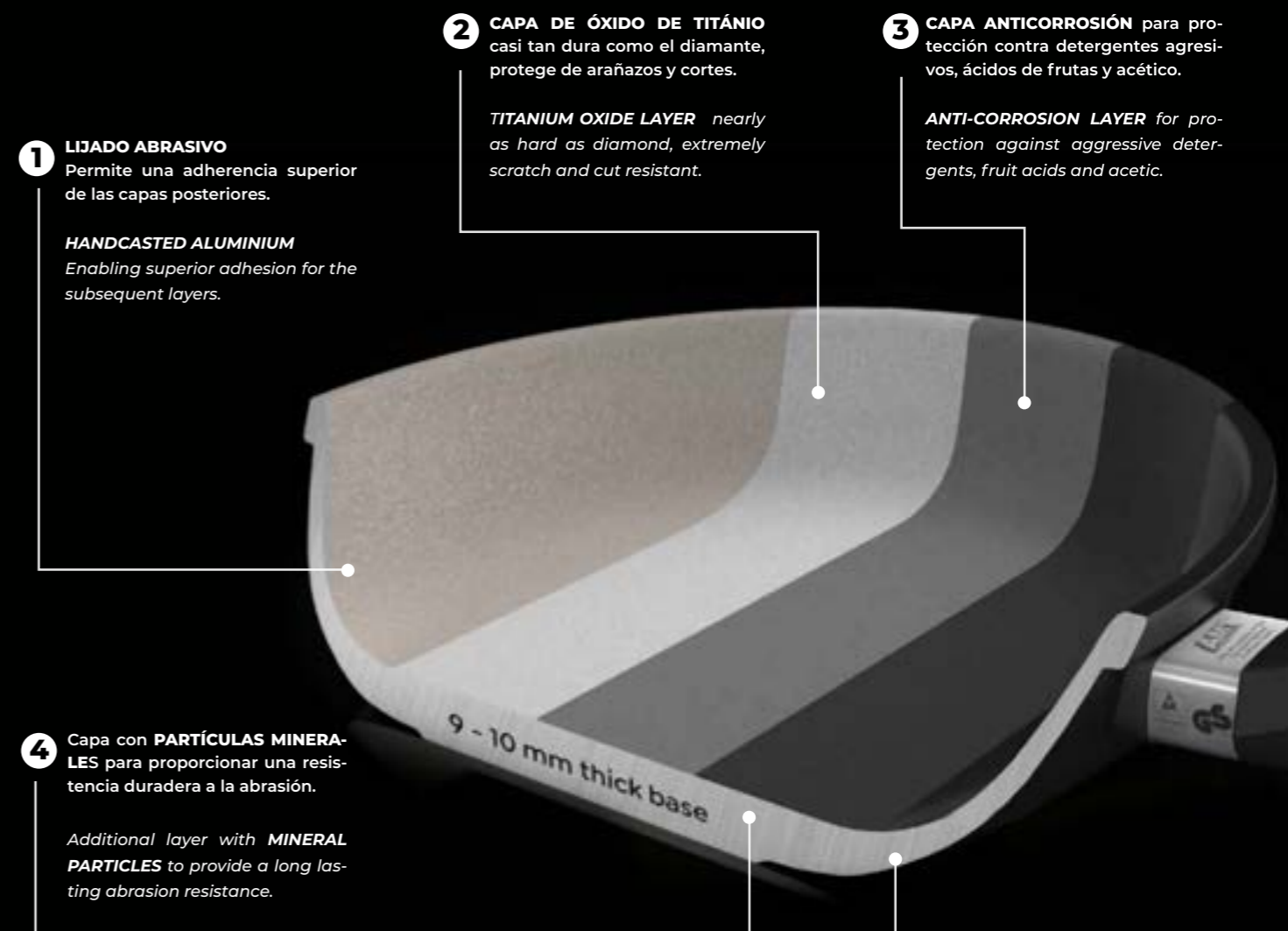

1 LIJADO ABRASIVO
Permite una adherencia superior de las capas posteriores.

HANDCASTED ALUMINIUM
Enabling superior adhesion for the subsequent layers.

2 CAPA DE ÓXIDO DE TITANIO
casi tan dura como el diamante, protege de arañazos y cortes.

TITANIUM OXIDE LAYER *nearly as hard as diamond, extremely scratch and cut resistant.*

3 CAPA ANTICORROSIÓN para protección contra detergentes agresivos, ácidos de frutas y acético.

ANTI-CORROSION LAYER *for protection against aggressive detergents, fruit acids and acetic.*

4 Capa con **PARTÍCULAS MINERALES** para proporcionar una resistencia duradera a la abrasión.

Additional layer with MINERAL PARTICLES *to provide a long lasting abrasion resistance.*

9 - 10 mm thick base

5 Capa de **REVESTIMIENTO ANTIADHERENTE**, fabricada con el exclusivo sellado Lotan con efecto antibacteriano.

NON-STICK COATING *layer, made from their unique Lotan sealing with anti-bacterial effect.*



GASTRONORM COOKING

Múltiples soluciones para cocina profesional.
Multiple solutions for professional kitchens.

ESPECIAL HORNOS DE CONVECCIÓN SPECIAL CONVECTION OVENS

Recubrimiento antiadherente de alto rendimiento y de fácil limpieza.

High-performance, easy-to-clean non-stick coating.



260 °C
Resiste a temperaturas de hasta 260°C°.

Temperature resistant up to 260°C°.



Fácil apilabilidad.
Facilita el transporte y almacenaje en buffet y cocinas profesionales.

Easy stackability.
Easy transport and storage in buffets and professional kitchens.



Apto para calentar en hornos de convección.

Suitable for heating in convection ovens.

Medidas GN 1/1 y 60x40cm compatibles con hornos de convección.

GN 1/1 and 60x40cm sizes compatible with convection ovens.



Cocción gastronorm / Gastronorm cooking

Bandeja Gn 1/1 Grill & Pizza

Tray Gn 1/1 Grill & Pizza
Plateau Gn 1/1 Grill Et Pizza
Vassoio Gn 1/1 Grill & Pizza
Gn-Backblech 1/1 Grill Und Pizza



REF.	WxL(mm)	H(mm)	€	MOQ
11828	GN 1/1	20		1
11829	60x40	20		1

Bandeja Gn 1/1 Bbq Perforada

Tray Gn 1/1 Perforated Bbq
Plateau Gn 1/1 Bbq Perforé
Vassoio Gn 1/1 Perforato Da Barbecue
Gn-Backblech 1/1 Bbqmit Schlitzen

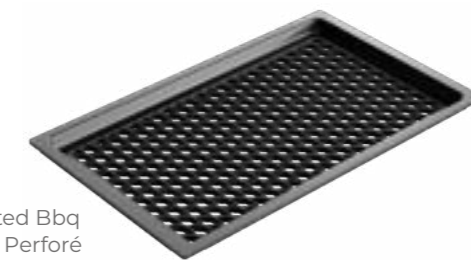

REF.	WxL(mm)	H(mm)	€	MOQ
11830	GN 1/1	20		1

Cesta Gn 1/1 Perforada

Gn Perforated Basket
Corbeille Gn 1/1 Perforée
Cestello Gn 1/1 Perforato
Gn-Korb Mit Löchern

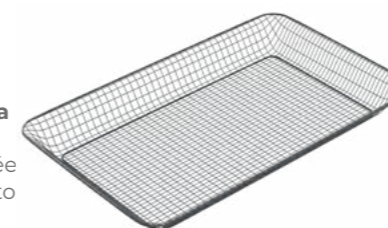

REF.	WxL(mm)	H(mm)	€	MOQ
11840	GN 1/1	40		1

Bandeja Gn 1/1 Perforada

Gn Tray 1/1 Perforated
Plateau Perforé Gn 1/1
Vassoio Gn 1/1 Accatastabile
Gn-Backblech 1/1 Stapelbar



REF.	WxL(mm)	H(mm)	€	MOQ
11841	GN 1/1	30		1

Bandeja Gn 1/1 11 Moldes

Gn Tray 1/1 11 Moulds
Plateau Gn 1/1 11 Moules
Vassoio Gn 1/1 Stampi
Gn-Backblech 1/1 Formen



REF.	WxL(mm)	H(mm)	€	MOQ
11842	GN 1/1	50		1

Bandeja Multiuso Baker

Baker Tray, Utility
Plateau Multiusage Baker
Vassoio Multiuso Baker
Backblech mehrzweck Baker



REF.	WxL(mm)	H(mm)	€	MOQ
11843	GN 1/1	20		1
11844	60x40	20		

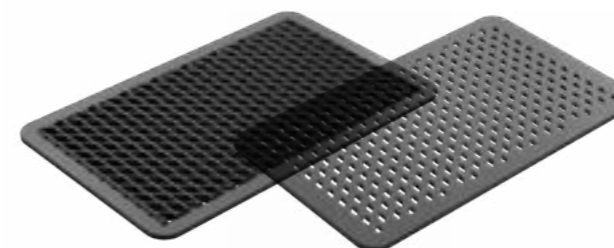

Bandeja Gn 1/1 Bbq & Smooth Perforada

Gn Tray 1/1 Bbq & Smooth, Perforated Plateau Gn 1/1 Bbq Et Smooth Perforé
Vassoio Gn 1/1 Bbq & Smooth Perforata
Gn-Backblech 1/1 Bbq & Smooth Mit Schlitzen

REF.	WxL(mm)	H(mm)	€	MOQ
11839	GN 1/1	10		1

Cubeta Gn 1/1

Gn Container 1/1
Plateau Gn 1/1
Vassoio Gn 1/1
Gn-Behälter 1/1



REF.	GN	WxL(mm)	H(mm)	€	MOQ
11989	1/1	530x325	55		1
11990	1/1	530x325	100		

GASTRONORM BUFFET

Cocinar y servir en un solo recipiente.
Cook and serve in a single container.



Medidas disponibles
Available sizes:

GASTRONORM

1/1 1/2 1/3 2/3

ALTURAS / HEIGHTS:
2cm / 5,5cm / 10cm



Apto para cocción y regeneración en horno.

Suitable for cooking and regenerating in the oven.



También disponible para inducción.

Also available for induction.

Recipientes con asas para mayor comodidad en el transporte y presentación.

Containers with handles for convenient transport and presentation.



260 °C

Apta a altas temperaturas de hasta 260 °C sin alterar la forma, gracias a la resistencia del aluminio fundido.

Suitable for high temperatures up to 260 °C without altering the shape, thanks to the strength of the cast aluminium.



Modelos sin asas para opciones donde dificulte la operativa (hornos horizontales, chafings, ...)

Models without handles for options where operation is difficult (horizontal ovens, chafing, ...).

Cubeta Gn Con Asas / Inducción
Gn Container With Handles/Induc.
Plateau Gn Avec Poignées Induc.
Vassoio Gn Con Manici /Induz.
Gn-Behälte Mit Henkel/Induk.



Cubeta Gn Inducción
Gn Container Induc.
Plateau Gn Induc.
Vassoio Gn Induz.
Gn-Behälte Induk.



REF.	GN	WxL(mm)	H(mm)	€	MOQ
11862	1/1	530x325	55		1
11863	1/1	530x325	100		1
11854	1/2	265x325	55		1
11851	1/3	176x325	55		1
11852	1/3	176x325	100		1
11856	2/3	354x325	55		1

REF.	GN	WxL(mm)	H(mm)	€	MOQ
11861	1/1	530x325	55		1
11853	1/2	265x325	55		1
11855	2/3	354x325	55		1

Bandeja Gn Con Asas / Inducción
Gn Container With Handles/Induc.
Plateau Gn Avec Poignées Induc.
Vassoio Gn Con Manici /Induz.
Gn-Behälte mit Henkel/Induk.



Bandeja GN BBQ con asas
Brochette grill
Gril à brochette
Griglia per spiedini
Grill für Spieße



REF.	GN	WxL(mm)	H(mm)	€	MOQ
11859	1/1	530x325	20		1
11857	2/3	354x325	20		1

REF.	GN	WxL(mm)	H(mm)	€	MOQ
11860	1/1	530x325	20		1
11858	2/3	354x325	20		1

SPEED OVEN ACCESSORIES

Regeneración más rápida y eficiente.
Faster and more efficient regeneration.

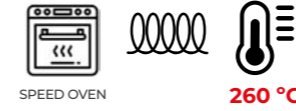

SPEED OVEN

260 °C

Speed oven

EFICIENCIA. EFFICIENCY.

Distribución rápida y uniforme del calor en toda la superficie de los accesorios. Tiempos de cocción más cortos sin comprometer la calidad.

Fast and even heat distribution on the whole surface of accessories. Shorter cooking times without compromising quality.

UTILIDAD. UTILITY.

Productos perfectos para la cocción y regeneración de una manera más rápida y efectiva.

Perfect products for warming, browning and baking in fast service.

VARIEDAD. VARIETY.

Selección de accesorios de Speed Ovens para una mayor comodidad y seguridad según cada necesidad de operativa de servicio.

Selection of Speed Ovens accessories for convenience and safety according to each service operation need.

Pala Snacks
Snack Scoop
Spatule À Snaks
Paletta Per Snack
Snack-Schaufel



REF.	WxL(mm)	H(mm)	€	MOQ
11849	425x29	10		1

Cuenco Cuadrado Snacks
Square Pie Dish Snacks
Bol Carré À Snaks
Recipiente Quadrato Snacks
Quadratische Snack-Schüssel



REF.	WxL(mm)	H(mm)	€	MOQ
11850	245x15	50		1

Bandeja Cuadrada Lisa
Square Tray Smooth
Plateau Carré Lisse
Vassoio Quadrato Liscia
Quadratisches Superglatt



REF.	WxL(mm)	H(mm)	€	MOQ
11845	260x260	30		1

Bandeja Cuadrada Grill
Square Tray Grill
Plateau Carré Grill
Vassoio Quadrato Grill
Quadratisches Grill

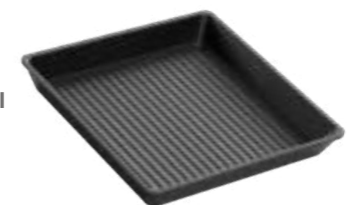

REF.	WxL(mm)	H(mm)	€	MOQ
11846	260x260	30		1

Pinza
Tong
Pince
Pinza
Pinzette



REF.	L(mm)	€	MOQ
11847	200		1

Bandeja Cuadrada Grill
Square Tray Grill
Plateau Carré Grill
Vassoio Quadrato Grill
Quadratisches Backblech Gril

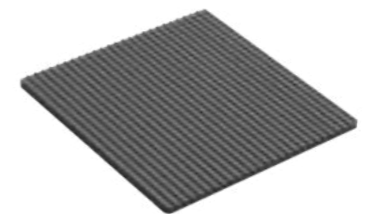

REF.	WxL(mm)	H(mm)	€	MOQ
11848	292x286	10		1

OTHERS

Cazuelas de alta capacidad.
High-capacity casseroles.



Otros / Others



260 °C

Soporta temperaturas de hasta 260 °C sin alterar la forma, gracias a la resistencia del aluminio fundido.

Withstands temperatures of up to 260°C without altering shape, thanks to the strength of the cast aluminium.



Conductividad térmica más eficiente gracias al aluminio fundido de 4 mm de grosor.

More efficient thermal conductivity thanks to 4 mm thick cast aluminium.



Superficie antiadherente. De 3 a 4 capas de revestimiento antiadherente y anticorrosión

Non-stick surface. 3 to 4 layers of non-stick and anti-corrosion coating.



Apto para cocción y para calentar en horno.

Suitable for baking and heating in the oven.



Apto para placas de inducción.

Suitable for induction hobs.



Mantiene una temperatura constante por un largo tiempo en toda las superficies.

Maintains a constant temperature for a long time on all surfaces.

Cazuela Gran Capacidad
Stock Pot
Casserole Grande Capacité
Casseruola Grande Capacita'
Grosser Schmortopf



REF.	Ø(mm)	H(mm)	€	MOQ
11831	380	70		1

Cazuela Gran Capacidad
Stock Pot
Casserole Grande Capacité
Casseruola Grande Capacita'
Grosser Schmortopf



REF.	Ø(mm)	H(mm)	€	MOQ
11832	50	80		1
11834	65	80		1
11837	80	100		1

Cazuela Gran Capacidad 2 segm.
Stock Pot
Casserole Grande Capacité
Casseruola Grande Capacita'
Grosser Schmortopf



REF.	Ø(mm)	H(mm)	€	MOQ
11833	50	80		1
11835	65	80		1

Cazuela Gran Capacidad 3 segm.
Stock Pot
Casserole Grande Capacité
Casseruola Grande Capacita'
Grosser Schmortopf



REF.	Ø(mm)	H(mm)	€	MOQ
11836	65	80		1
11838	80	100		1



La cuidadosa selección de nuestros materiales: Aluminio fundido a presión.
The careful selection of our materials: Die-cast aluminium.



Seleccionamos cuidadosamente las técnicas y los materiales más avanzados para crear nuestros productos. El uso exclusivo de aluminio fundido a presión (una materia prima certificada para uso alimentario) proporciona una distribución óptima y constante del calor, así como una gran resistencia a los diferentes métodos de cocción y un proceso de cocción más natural

We carefully select the most advanced techniques and materials to create our products. The exclusive use of die-cast aluminium (a raw material certified for food use) provides an optimal and constant heat distribution, as well as a high resistance to different cooking methods and a more natural cooking process.

Cocción homogénea.
Homogeneous cooking.

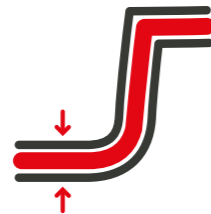

El aluminio fundido a presión tiene excelentes propiedades de conducción del calor y los alimentos se cocinan de manera uniforme sin que se quemen ni se altere su sabor, manteniendo las propiedades nutritivas en cada tipo de alimento.

The die-cast aluminium has excellent heat conduction properties and the food cooks evenly without burning or altering its taste, maintaining the nutritional properties in each type of food.

El aluminio está fundido a presión con un grosor considerable que distribuye el calor de manera uniforme y una base resistente a la deformación.

The aluminium is die-cast with a considerable thickness that distributes heat evenly and a base that is resistant to deformation.

No pierde calor, lo que permite ahorrar energía. Incluso cuando se apaga la fuente de calor, mantiene la temperatura durante otros 10/15 minutos manteniendo los alimentos calientes mientras se sirven en la mesa.

It doesn't lose heat, which saves energy. Even when the heat source is turned off, it maintains the temperature for another 10/15 minutes keeping the food warm while it's being served at the table.



ELDIAMANT[®]
PROFILE

La gama BLACKplus incluye en exclusiva el revestimiento ELDIAMANT PROFILE de última generación, capaz de garantizar una resistencia a las rayadas sin precedentes en los recubrimientos antiadherentes. El cuerpo en aluminio fundido de alto espesor para obtener ligereza, indeformabilidad y mejor distribución del calor, ELDIAMANT PROFILE con partículas minerales para cocinar sin aceite.

The BLACKplus range exclusively includes the latest generation ELDIAMANT PROFILE coating, capable of guaranteeing unprecedented scratch resistance in non-stick coatings. The high thickness cast aluminium body for lightness, non-deformability and better heat distribution, ELDIAMANT PROFILE with mineral particles for oil-free cooking.



40.000
ciclos de uso.



La garantía del producto es de (2+1 años) desde el momento de la compra (presentando el comprobante) y si se respetan las instrucciones de uso. Risolí no se hace responsable de daños causados por un incorrecto uso del producto.

The product is guaranteed (2+1 years) from the moment of purchase (presenting the receipt) and if the instructions for use are followed. Risolí is not responsible for any damage caused by incorrect use of the product.



Sartén fusa

18/10 - 18/10

Espesor 6 - 7 mm

6 - 7 mm thickness.

Mango de acero inoxidable 18/10 termoaislante con 4 remaches.

Stainless steel handle 18/10 heat protection with 4 rivets.

Revestimiento interior Teflon Profile antiadherente resistente al rayado.

Inside non stick coating TeFlon Platinum scratch resistant.

Garantía ECOCAST 3 años.

3 years ECOCAST guarantee.



INOX STAINLESS STEEL 304

Sartén fusa 18/10
Frypan Fusa 18/10
Poele fusa 18/10
Padella fusa 18/10
Pfanne fusa 18/10

ALUMINIO FUNDIDO
CAST ALUMINIUM

REF.	Ø(mm / inches)	e(mm)	L(mm)	€	MOQ
10000	240/9,4"	0,6	50		1
10001	280/11"	0,6	52		1
10002	320/12,5"	0,6	58		1



INOX STAINLESS STEEL 304

Sartén honda fusa 18/10
Deep frypan Fusa 18/10
Poele profonde fusa 18/10
Padella profonda fusa 18/10
Tiefe pfanne fusa 18/10

ALUMINIO FUNDIDO
CAST ALUMINIUM

REF.	Ø(mm / inches)	e(mm)	L(mm)	€	MOQ
10004	240/9,4"	0,6	70		1
10005	280/11"	0,6	70		1
10006	320/12,5"	0,6	80		1
10007	360/14"	0,6	80		1



FONDO: Alto espesor para una perfecta difusión del calor.

BOTTOM: High thickness for perfect heat diffusion.

Apto para cocinas de gas, eléctricas, vitrocerámicas y horno.

Suitable for gas, electric, glass-ceramic, oven and induction cookers.

Diseño innovador y exclusivo para un agarre seguro.

Innovative and exclusive design for a secure grip.

Remache exterior especial.

Special external rivet.

Sartén Classica



INOX STAINLESS STEEL 304

Sartén Classica
Frypan Classica
Poele Classica
Padella Classica
Pfanne Classica

ALUMINIO FUNDIDO
CAST ALUMINIUM

REF.	Ø(mm / inches)	e(mm)	L(mm)	€	MOQ
10008	240/9,4"	0,6	50		1
10009	280/11"	0,6	52		1
10010	320/12,5"	0,6	58		1
10011	360/14"	0,6	60		1



INOX STAINLESS STEEL 304

Sartén honda Classica
Deep frypan Classica
Poele profonde Classica
Padella profonda Classica
Tiefe pfanne Classica

ALUMINIO FUNDIDO
CAST ALUMINIUM

REF.	Ø(mm / inches)	e(mm)	L(mm)	€	MOQ
10012	240/9,4"	0,6	70		1
10013	280/11"	0,6	70		1
10014	320/12,5"	0,6	80		1
10015	360/14"	0,6	80		1

Sartén Ergo



MANGO
BAQUELITA
BAKELITE
HANDLE
200°C



Sartén Ergo Prof
Frypan Ergo Prof
Poele Ergo Prof
Padella Ergo Prof
Pfanne Ergo Prof

ALUMINIO
FUNDIDO
CAST
ALUMINIUM

REF.	Ø(mm/inches)	e(mm)	L(mm)	€	MOQ
10016	200/7,8"	0,7	50		1
10017	240/9,4"	0,7	52		1
10018	280/11"	0,7	58		1
10019	320/12,5"	0,7	60		1



Sartén honda Ergo Prof
Deep frying pan Ergo Prof
Poele profonda Ergo Prof
Padella profonda Ergo Prof
Tiefe pfanne Ergo Prof

ALUMINIO
FUNDIDO
CAST
ALUMINIUM

REF.	Ø(mm/inches)	ml	e(mm)	L(mm)	€	MOQ
10020	240/9,4"	200	0,9	80		1
10021	280/11"	300	0,9	85		1



Whitford

Grill mango silicona abatible
Grill "xl" silicone handle
gril manche rabattable
griglia maniglie estraibile
gril ausziehbar griff



REF.	WxL(mm)	ml	e(mm)	H(mm)	€	MOQ
10811	260x330	-	0,6	50		1



Disponibile en 3 colores
Available in 3 colours



Plancha burger
Burger griddle
Plancha burger
Piastra burger
Grillplatte burger

Whitford

REF.	WxL(mm)	ml	e(mm)	H(mm)	€	MOQ
10073	400x240	-	0,6	30		1

MANGO
BAQUELITA
BAKELITE
HANDLE
200°C



Grill asa BK
Grill BK handle
Gril asa BK
Griglia manico BK
Grillgriff BK



REF.	Ø(mm/inches)	ml	e(mm)	H(mm)	€	MOQ
10044	260x260	-	0,7	40		1

MANGO
BAQUELITA
BAKELITE
HANDLE
200°C



Wok mango BK
Wok BK handle
Wok manche BK
Wok maniglie BK
Wok Griff BK



REF.	Ø(mm/inches)	ml	e(mm)	H(mm)	€	MOQ
10057	300/11,8"	-	0,6	90		1



Horno / Especial Oven / Special

Whitford

Huevo & dulce
Egg & sweet
Oeuf & sucré
Uovo e dolce
Ei & süß



PORCIÓN
INDIVIDUAL
INDIVIDUAL
PORTION

REF.	Ø (mm/inches)	ml	e (mm)	L (mm)	€	MOQ
10022	140/5,5"	-	0,5	30		1

Whitford

Mini finger grill
Mini finger grill
Mini finger grill
Mini finger griglia
Mini finger grillpfanne



PORCIÓN
INDIVIDUAL
INDIVIDUAL
PORTION

REF.	WxL (mm/inches)	e (mm)	H (mm)	€	MOQ
10025	320x160/126x6,2"	0,5	30		1



ELDIAMANT[®]
PROFILE

Mini cacerola
Mini saucepan
Mini casserole
Mini casseruola
Mini kasserolle



COMPATIBLE CON (P.327)

10064 - 10065



REF.	Ø (mm/inches)	ml	e (mm)	H (mm)	€	MOQ
10023	160/6,2"	100	0,5	68		1
10024	200/7,8"	150	0,5	70		1



ELDIAMANT[®]
PROFILE

Cacerola grand gourmet
Grand gourmet saucepan
Casserole grand gourmet
Casseruola grand gourmet
Kasserolle grand gourmet



COMPATIBLE CON (P.327)

10066 - 10067 - 10068 - 10069



REF.	Ø (mm/inches)	ml	e (mm)	L (mm)	€	MOQ
10027	240/9,4"	200	0,6	70		1
10028	280/11"	300	0,6	75		1
10029	320/12,5"	450	0,6	85		1
10030	360/14,1"	550	0,6	85		1



ELDIAMANT[®]
PROFILE

Cacerola alta grand gourmet
Grand gourmet high saucepan
Casserole haute grand gourmet
Casseruola alta grand gourmet
Hohe Kasserolle grand gourmet



COMPATIBLE CON (P.327)

10065 - 10066 - 10067



REF.	Ø (mm/inches)	ml	e (mm)	L (mm)	€	MOQ
10031	200/7,8"	250	0,6	105		1
10032	240/9,44"	350	0,6	106		1
10033	280/11"	450	0,6	110		1



ELDIAMANT[®]
PROFILE

Cazo 1 mango grand gourmet
Grand gourmet pot 1 handle
Casserole 1 manche grand gourmet
Casseruola 1 mangico grand gourmet
Kasserolle 1 griff grand gourmet



COMPATIBLE CON (P.327)

10064



REF.	Ø (mm/inches)	ml	e (mm)	L (mm)	€	MOQ
10034	160/6,2"	150	0,5	102		1

MANGO
BAQUELITA
BAKELITE
HANDLE
200°C

Aluminio Fundido / Cast Aluminium



Le Pignatte

Cocción lenta / Slow Cooking



Le Pignatte[®]



Más fácil de limpiar
Easier to clean



Más ligera que el hierro fundido
Lighter than cast iron



Mejor presentación
Better performance



ELDIAMANT[®]
PROFILE

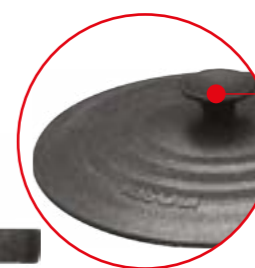

El pomo aguanta temperatura
de hasta 200°C

The knob withstands tempera-
tures up to 200°C.



200°C



Cacerola de cocción lenta "Le Pignatte"
Slow cooking soucepot "Le Pignatte"
Casserole à la mijoteuse "Le Pignatte"
Casseruola a cottura lenta "Le Pignatte"
Kasserolle langsamen Kochen "Le Pignatte"

REF.	Ø (mm/inches)	ml	e (mm)	L (mm)	€	MOQ
10035	200/7,8"	225	0,7	101		1
10036	240/9,4"	350	0,7	106		1
10037	280/11"	450	0,7	114		1



Horno / Especial
Oven / Special



Ondulación para una mayor circulación del aire en el horno.
Undulation for greater air circulation in the oven.



Grill pizza
Grill pizza
Gril pizza
Griglia pizza
Grill pizza



REF.	WxL(mm)	ml	e(mm)	H(mm)	€	MOQ
10041	400x340	-	0,8	30		1

COMPATIBLE
CALIU



Grill para pinchos
Brochette grill
Gril à brochette
Griglia per spiedini
Grill für spieße



REF.	WxL(mm)	ml	e(mm)	H(mm)	€	MOQ
10040	470x260	-	0,6	50		1

46 x 25 CM

31 x 25 CM



Plancha grill
Servigrill
Plaque de grill
Piastra grigliata
Grillplatte



REF.	WxL(mm)	ml	e(mm)	H(mm)	€	MOQ
10042	460x250	-	0,6	30		1
10735	460x250		0,6	30		1



Grill barbacoa
Grilled barbecue
Gril barbecue
Piastra barbecue
Grill grillen

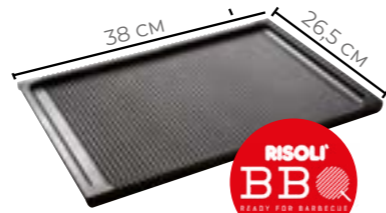

REF.	WxL(mm)	ml	e(mm)	H(mm)	€	MOQ
10038	380x265	-	0,6	20		1



Placa grill doble
Dual grill plate
Plaque de grill double
Piastra dual grill
Doppelte grillplatte



REF.	WxL(mm)	ml	e(mm)	H(mm)	€	MOQ
10071	300x225	-	0,5	20		1



Grill horno
Oven grill
Gril four
Griglia forno
Grill ofen



REF.	WxL(mm)	ml	e(mm)	H(mm)	€	MOQ
10072	360x180	-	0,5	18		1

Aluminio Fundido / Cast Aluminium



Parrilla



ELDIAMANT®
PROFILE

Grill ovalado para pescado
Oval fish grill
Grill à poisson ovale
Pesciera ovale
Ovale Fischpfanne



ALUMINIO
FUNDIDO
CAST
ALUMINIUM

REF.	WxL (mm)	ml	€	MOQ
10039	460x265	-		1



ELDIAMANT®
PROFILE

COMPATIBLE
CALIU

Rustidera
Lasagna pan
Plat à rôtir
Rostiera
Lasagneform



ALUMINIO
FUNDIDO
CAST
ALUMINIUM

REF.	WxL (mm)	ml	€	MOQ
11604	400x250	5700		1



Tapa vidrio
Glass Lid
Couvercle verre
Coperchio vetro
Glasdeckel

REF.	Ø (mm/inches)	€	MOQ
BOROSILICATO			
10064	160/6,2"		1
10065	200/7,8"		1
10066	240/9,4"		1
10067	280/11"		1
10068	320/12,5"		1
VIDRIO TEMPLADO			
10069	360/14,1"		1



Disco inductor universal
Universal inductor disc
Disque inducteur universel
Disco induttore universale
Universal-induktorscheibe

REF.	Ø (mm)	ml	€	MOQ
10070	260	-		1



Salvamantel silicona verde
Silicone trivet green
Sottopivetto in silicone verde
Dessous de plat silicone vert
Untersatz aus silikon grün

REF.	WxL (mm)	H (mm)	€	MOQ
10813	170x170	30		4
10814	190x190	30		4



Set 2 agarraderas silicona negro
Set 2 silicone handle black
Set 2 manici in silicone nero
Set 2 manche en silicone noir
Set 2 silikongriff schwarz

REF.	€	MOQ
10812		4



MOLDE PARA HORNEAR REPOSTERÍA CREATIVA
BAKING MOLD FOR CREATIVE CAKES

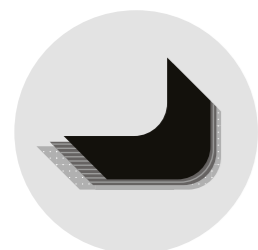

**EXCELENTE
ANTIADHERENTE**
EXCELLENT
NON-STICK



**GRAN ESPESOR,
ROBUSTO**
EXTRA THICK,
EXTREME HARD



**PARA TARTAS
CREATIVAS**
FOR CREATIVE
CAKES

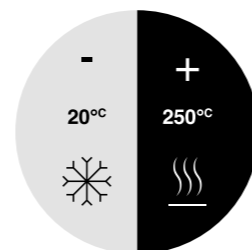

**PERFECTO
DE -20° A 250°**
PERFECT FROM
-20° TO 250°C

Black Plus®
ELDIAMANT®
PROFILE

Los fondos extragrosos y los revestimientos antiadherentes de los moldes garantizan no solo el horneado, gracias a su correcta conducción del calor, sino también asegura que mantengan mejor su forma que otros moldes similares, haciéndolos perfectos también para servir en la mesa.

Extra thick bottoms and non-stick coatings guarantee not just even baking thanks to correct heat conduction, but also ensure the tins keep their shape better than others on the market, making them perfect also for serving at the table.



ROYAL D'ALÙ. DESDE 1965.

Diseño: Mínima 2020
Design: Minimal 2020

Material: Aluminio fundido - hecho a mano
Material: Cast Aluminium - Handmade

Capa: Verde, Granito, Perfil
Coating: Green, Granito, Profile

Garantía: 2 años
Warranty: 2 years



Tarta de plato hondo "crostata" 4/6 personas
Deep dish tart "crostata" 4/6 people
Tarte creuse "crostata" 4/6 personnes
Crostata 4/6 persone
Deep dish torte "crostata" 4/6 personen

REF.	Ø(mm/inches)	ml	€	MOQ
10062	240	200		1



Tarta de plato hondo "ciambellone" 6/8 personas
Deep dish tart "ciambellone" 6/8 people
Tartelette "ciambellone" 6/8 personnes
Ciambellone con foro 6/8 persone
"Ciambellone"-torte 6/8 personen

REF.	Ø(mm/inches)	ml	€	MOQ
10063	260	200		1



Sartén pancake con mango BK
Pancake frypan with BK handle
Poêle pancake avec manche BK
Padella pancake manico BK
Pfanne pancake mit BK-griff

REF.	Ø(mm/inches)	ml	e(mm)	H(mm)	€	MOQ
10060	250/9,8"	-	65	25		1



Sartén creps con mango BK
Crepe frying pan with BK handle
Crêpe poêle avec manche BK
Crepe padella manico BK
Pfanne Krepp mit BK-griff

REF.	Ø(mm/inches)	ml	e(mm)	H(mm)	€	MOQ
10061	280/11"	-	65	23		1

Descubre
la plancha
grill GN.



Estructura de placa de aleación de aluminio con conductividad térmica muy alta e indeformable.

Aluminium alloy plate structure with very high thermal conductivity and non-deformable.

Certificado antiadherente de alta calidad.

High quality non-stick certificate.

Zonas de desagüe de cocina para no mezclar los sabores.

Kitchen drainage areas so as not to mix flavours.

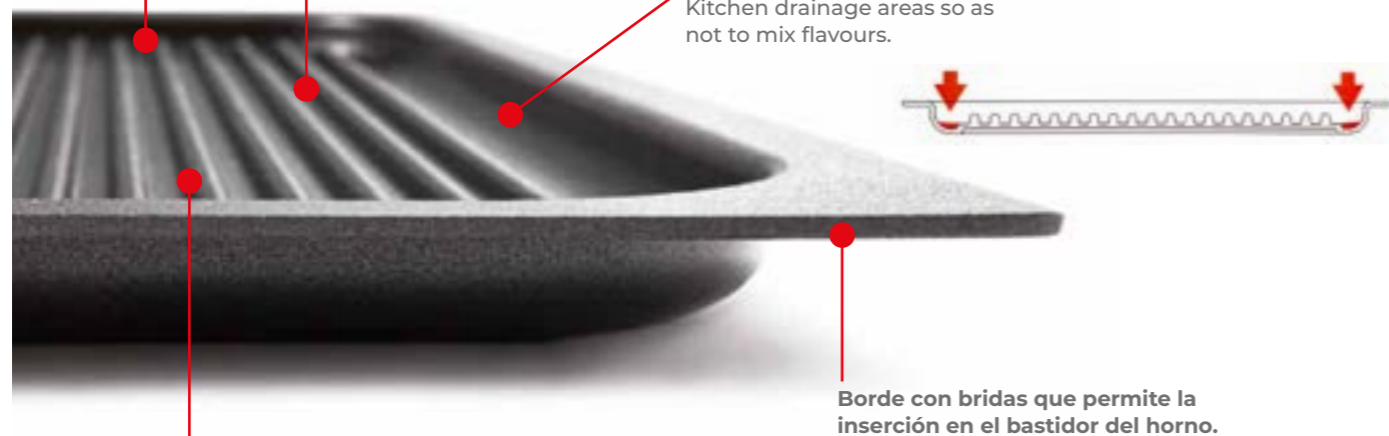

Rayadura y relieves para evitar el efecto fritura.

Scratches and reliefs to avoid the frying effect.

Borde con bridas que permite la inserción en el bastidor del horno.

Flanged edge for insertion into the oven frame.



SIZE
1/1
GN

SIZE
2/3
GN

Plancha grill GN

GN grill
Plaque de cuisson GN
Piastra Griglia GN
Grill Platte GN

REF.	WxL(mm)	GN	e(mm)	H(mm)	€	MOQ
10045	530x325	1/1	0,7	20		1
11603	235x530	2/3	0,7	20		1



* Nicola Ostinelli
Proprietario del ristorante Il Diavolo
L'acqua Santa

CUBETA GN EN ALUMINIO CON ANTIADHERENTE HARD STONE

Aluminium Baking Pans With non-stick coating



GN 1/1

REF.	WxL(mm)	ml	e(mm)	H(mm)	€	MOQ
10046	530x325	-	1,5	20		1
10047	530x325	-	1,5	40		1
10048	530x325	-	1,5	65		1

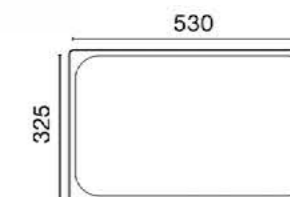

GN 2/3

REF.	WxL(mm)	ml	e(mm)	H(mm)	€	MOQ
10049	355x325	-	1,5	20		1
10050	355x325	-	1,5	40		1
10051	355x325	-	1,5	65		1

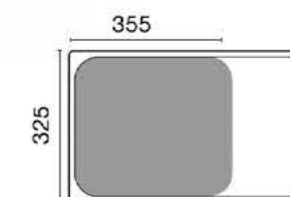

GN 1/2

REF.	WxL(mm)	ml	e(mm)	H(mm)	€	MOQ
10052	265x325	-	1,5	20		1
10053	265x325	-	1,5	40		1

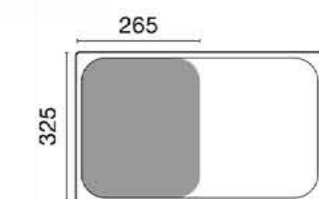



ELDIAMANT®
PROFILE

Rustidera
Lasagna pan
Plat à rôtir
Rostiera
Lasagneform



COMPATIBLE
CALIU

ALUMINIO
FUNDIDO
CAST
ALUMINIUM

REF.	LxW (mm)	€	MOQ
11604	250x400		1



Sartén BBQ
BBQ frypan
Poêle BBQ
Padella BBQ
Pfanne BBQ



REF.	Ø (mm/inches)	ml	e (mm)	H (mm)	€	MOQ
10058	320/11"	-	6	58		1



Paellera BBQ
Paella pan BBQ
Poêle à paella BBQ
Paellera BBQ
Paella-pfanne BBQ



REF.	Ø (mm/inches)	ml	e (mm)	H (mm)	€	MOQ
10059	320/11"	-	6	58		1



Paellera mango inox
Inox handle saucepan
Poêle à manche inox
Paellera manico inox
Bratpfanne mit Edelstahlgriff



REF.	Ø (mm/inches)	ml	e (mm)	H (mm)	€	MOQ
10054	280/11"	150	6	48		1
10055	320/12,5"	250	6	52		1
10056	360/14,1"	350	6	58		1



Grill para pinchos
Brochette grill
Gril à brochette
Griglia per spiedini
Grill für spieße



COMPATIBLE
CALIU

REF.	WxL (mm)	e (mm)	H (mm)	€	MOQ
10040	470x260	6	50		1

Grill horno
Oven grill
Gril four
Griglia forno
Grill ofen



REF.	WxL (mm)	e (mm)	H (mm)	€	MOQ
10072	360x180	5	18		1

Accesorios BBQ / BBQ Accessories

Grill barbecue
Grilled barbecue
Gril barbecue
Piastra barbecue
BBQ grill

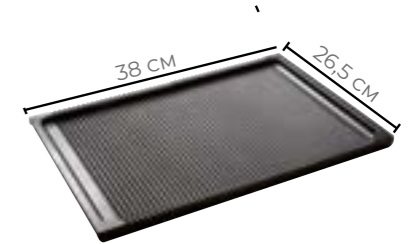

REF.	WxL (mm)	e (mm)	H (mm)	€	MOQ
10038	380x265	6	20		1

Placa grill doble
Dual grill plate
Plaque de grill double
Piastra dual grill
Doppelte grillplatte



REF.	WxL (mm)	e (mm)	H (mm)	€	MOQ
10071	300x225	5	20		1

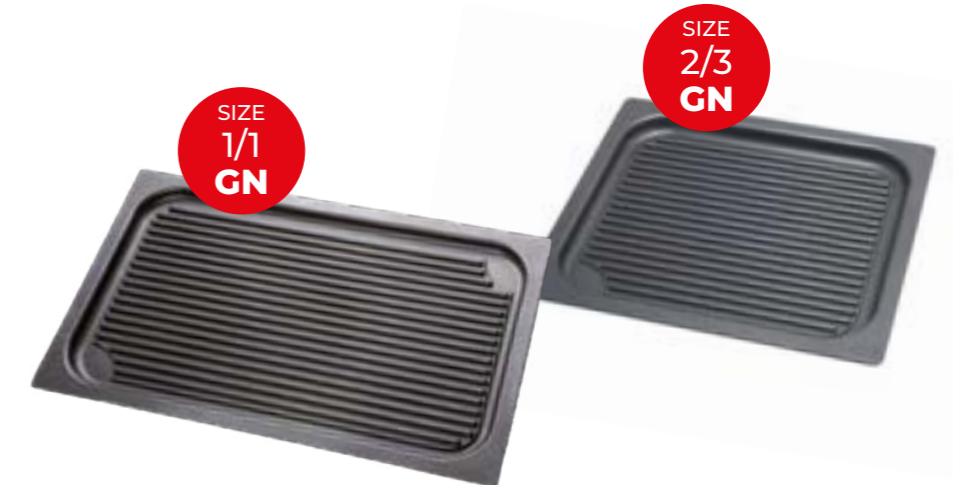

Plancha grill GN
GN grill
Plaque de cuisson GN
Piastra Griglia GN
Grill Platte GN

REF.	WxL (mm)	GN	e (mm)	H (mm)	€	MOQ
10045	530x325	1/1	0,7	20		1
11603	235x530	2/3	0,7	20		1

Cocina / Kitchen

Certificado
contacto
alimentario.



Nuestras cubetas GN de acero AISI 304 son compatibles con las principales marcas GASTRONORM.

El radio de las esquinas más abierto permite una mejor y más fácil apilabilidad y optimiza la capacidad de las cubetas.

Our AISI 304 steel GN trays are compatible with the main GASTRONORM brands.

The more open corner radius allows for better and easier stackability and optimises the capacity of the trays.



Alta calidad garantizada.
High quality guaranteed.



Resistencia a la corrosión.
Corrosion resistance.



Máxima capacidad.
Maximum capacity.

Gastronorm / Cubetas Gastronorm / Cubetas

Tamaños GN / GN Sizes:

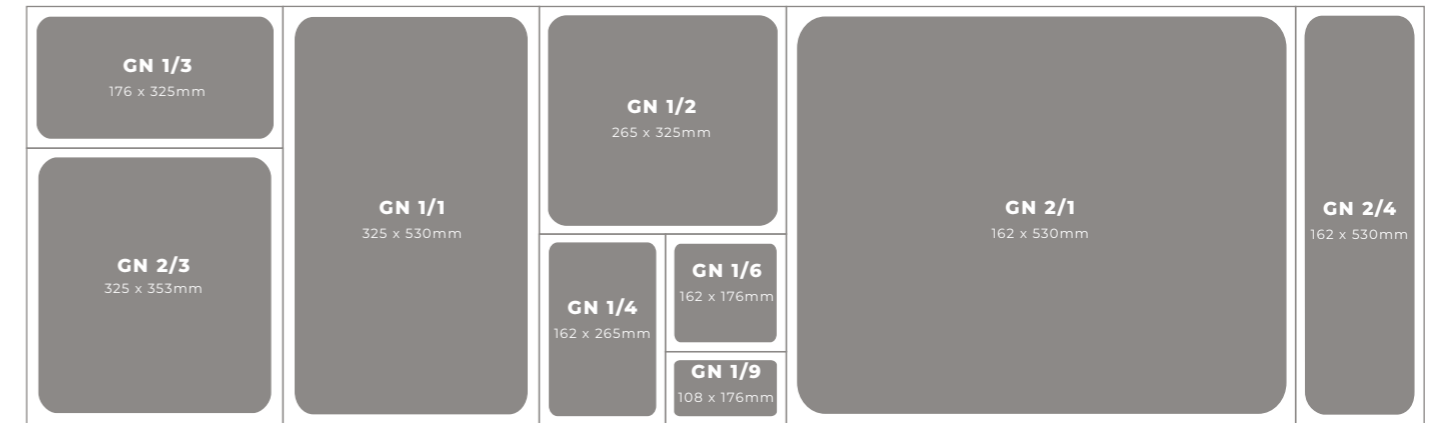

*medidas exteriores / external dimensions

Altura GN / GN High:



Apto horno.
Oven save.



Apto lavavajillas.
Dishwasher save.



Apilable.
Stackable.



-20°C
300°C



Apto contacto
alimentario.
Food contact save.



Apto horno.
Oven save.



Apto lavavajillas.
Dishwasher save.



Apilable.
Stackable.



-20°C
300°C



Apto contacto
alimentario.
Food contact save.

COMPATIBLE CON
LAS PRINCIPALES
MARCAS DEL
MERCADO

COMPATIBLE WITH
THE MAIN BRANDS
ON THE MARKET



El radio de las esquinas más abierto permite una mejor y más fácil apilabilidad y optimiza la capacidad de las cubetas.

The more open corner radius allows for better and easier stackability and optimises the capacity of the trays.

GN 1/1 - 325 X 530 mm



REF.	H(mm)	e(mm)	LT	€	UE / MOQ
10147	20	0,7			1-0-6-24-120 / 6
10148	40	0,7			1-0-6-24-120 / 6
10149	55	0,7			1-0-6-24-120 / 6
10150	65	0,8	8,8		1-0-6-24-120 / 6
11089	65	0,7	8,8		1-0-6-24-120 / 6
10151	100	0,7	13,7		1-0-6-24-120 / 6
10153	150	0,7	20		1-0-6-24-120 / 6
10154	200	0,7	27,8		1-0-6-24-120 / 6

GN 1/2 - 265 X 325 mm



REF.	H(mm)	e(mm)	LT	€	UE / MOQ
10164	20	0,7			1-0-6-24-120 / 6
10166	40	0,7			1-0-6-24-120 / 6
10168	65	0,7	8,8		1-0-6-24-120 / 6
10170	100	0,7	13,7		1-0-6-24-120 / 6
10172	150	0,7	20		1-0-6-24-120 / 6
10173	200	0,7	27,8		1-0-6-24-120 / 6

GN 1/3 - 176 X 325 mm



REF.	H(mm)	e(mm)	LT	€	UE / MOQ
10179	20	0,7			1-6-18-0-0 / 6
10181	40	0,7			1-6-18-0-0 / 6
11905	55	0,7			1-6-18-0-0 / 6
10183	65	0,7	2,4		1-6-18-0-0 / 6
10185	100	0,7	3,5		1-6-18-0-0 / 6
10187	150	0,7	5,4		1-6-18-0-0 / 6
10188	200	0,7	7,2		1-0-6-0-0 / 6

GN 1/4 - 162 X 265 mm

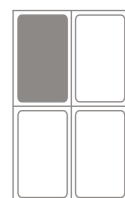

REF.	H(mm)	e(mm)	LT	€	UE / MOQ
10190	20	0,7			1-6-24-0-0 / 6
10432	40	0,7			1-6-24-0-0 / 6
10192	65	0,7	1,7		1-6-24-0-0 / 6
10194	100	0,7	2,5		1-6-24-0-0 / 6
10195	150	0,7	3,8		1-6-24-0-0 / 6
10196	200	0,7	4,8		1-6-24-0-0 / 6



GN 1/6 - 162 X 176 mm



REF.	H(mm)	e(mm)	LT	€	UE / MOQ
10197	65	0,7	1		1-6-36-0-0 / 6
10199	100	0,7	1,5		1-6-36-0-0 / 6
10200	150	0,7	2,3		1-6-36-0-0 / 6
10201	200	0,7	3,3		1-6-36-0-0 / 6

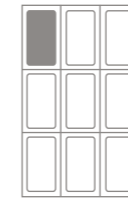

GN 1/9 - 108 X 176 mm



REF.	H(mm)	e(mm)	LT	€	UE / MOQ
10203	65	0,7	0,6		1-6-48-0-0 / 6
10205	100	0,7	0,8		1-6-48-0-0 / 6

GN 2/1 - 650 X 530 mm



REF.	H(mm)	e(mm)	LT	€	UE / MOQ
10141	20	0,8			1-0-6-24-120 / 6
10142	40	0,8			1-0-6-24-120 / 6
10143	65	0,8	8,8		1-0-6-24-120 / 6
10144	100	0,8	13,7		1-0-6-24-120 / 6
10145	150	0,8	20		1-0-6-24-120 / 6
10146	200	0,8	27,8		1-0-6-24-120 / 6

GN 2/4 - 162 X 530 mm



REF.	H(mm)	e(mm)	LT	€	UE / MOQ
10175	65	0,7	0,7		1-6-24-0-0 / 6
10176	100	0,7	0,7		1-6-24-0-0 / 6
10177	150	0,7	0,8		1-6-24-0-0 / 6

GN 2/3 - 325 X 353 mm



REF.	H(mm)	e(mm)	LT	€	UE / MOQ
10155	20	0,7	0,7		1-6-24-0-0 / 6
10157	40	0,7	0,7		1-6-24-0-0 / 6
10159	65	0,7	0,8		1-6-24-0-0 / 6
10160	100	0,7			1-6-24-0-0 / 6
10161	150	0,7			1-6-24-0-0 / 6
10162	200	0,7			1-6-24-0-0 / 6

Fondo perforado
Perforated bottom
Egouttoirs pour bacs
Falso fondo forato
Abtropfgitter



Perfil divisorio gastronorm
Adaptable bars
Barrettes de composition
Separatore
Adapter



REF.	W(mm)	L(mm)	e(mm)	FORMATO	€
10206	470	590	0,7	GN 2/1	
10207	469	269	0,7	GN 1/1	
10209	271	211	0,7	GN 1/2	
10210	266	116	0,7	GN 1/3	
10211	118	106	0,7	GN 1/6	

REF.	FORMATO	e(mm)	€
10212	GN 1/1	0,7	
10213	GN 1/2	0,7	

GN 1/1 - Perforated - Perforé - Forate - Perforiert - 325 X 530 mm

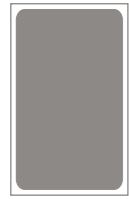

REF.	H(mm)	e(mm)	LT	€	UE / MOQ
10220	20	0,7			1-0-6-24-120 / 6
10221	40	0,7			1-0-6-24-120 / 6
10222	55	0,7			1-0-6-24-120 / 6
10223	65	0,7	8,8		1-0-6-24-120 / 6
10224	100	0,7	13,7		1-0-6-24-120 / 6
10225	150	0,7	20		1-0-6-24-120 / 6
10226	200	0,7	27,8		1-0-6-24-120 / 6

GN 1/2 - Perforated - Perforé - Forate - Perforier - 265 X 325 mm

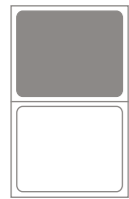

REF.	H(mm)	e(mm)	LT	€	UE / MOQ
10234	65	0,7	8,8		1-0-6-24-120 / 6
10235	100	0,7	13,7		1-0-6-24-120 / 6
10236	150	0,7	20		1-0-6-24-120 / 6
10237	200	0,7	27,8		1-0-6-24-120 / 6

GN 1/3 - Perforated - Perforé - Forate - Perforier - 176 X 325 mm



REF.	H(mm)	e(mm)	LT	€	UE / MOQ
10238	40	0,7			1-6-18-0-0 / 6
10239	65	0,7	2,4		1-6-18-0-0 / 6
10240	100	0,7	3,5		1-6-18-0-0 / 6
10241	150	0,7	5,4		1-6-18-0-0 / 6
10242	200	0,7	7,2		1-6-18-0-0 / 6

GN 2/1 - Perforated - Perforé - Forate - Perforier - 650 X 530 mm

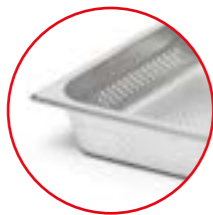

REF.	H(mm)	e(mm)	LT	€	UE / MOQ
10214	20	0,8			1-6-24-0-0 / 6
10215	40	0,8			1-6-24-0-0 / 6
10216	65	0,8	1,7		1-6-24-0-0 / 6
10217	100	0,8	2,5		1-6-24-0-0 / 6
10218	150	0,8	3,8		1-6-24-0-0 / 6
10219	200	0,8	4,8		1-6-24-0-0 / 6

GN 2/3 - Perforated - Perforé - Forate - Perforier - 325 X 353 mm

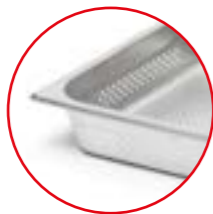

REF.	H(mm)	e(mm)	LT	€	UE / MOQ
10227	20	0,7			1-6-24-0-0 / 6
10228	40	0,7			1-6-24-0-0 / 6
10230	65	0,7	1,7		1-6-24-0-0 / 6
10231	100	0,7	2,5		1-6-24-0-0 / 6
10232	150	0,7	3,8		1-6-24-0-0 / 6
10233	200	0,7	4,8		1-6-24-0-0 / 6



Apto para horno.
Oven safe.

GN / Inox AISI 304 - 18/10
GN / Stainless Steel 304 - 18/10

Tapa GN

GN Lid - Couvercle GN - Coperchio GN - GN-deckel - 162 X 176 mm



REF.	GN	e(mm)	€	UE / MOQ
10243	1/1	0,7		1-0-6-0-0 / 6
11912	2/1	0,8		1-0-6-0-0 / 6
10245	2/3	0,7		1-0-6-0-0 / 6
10247	1/2	0,7		1-0-6-0-0 / 6
10249	1/3	0,7		1-0-6-0-0 / 6
10251	1/4	0,7		1-0-6-0-0 / 6
10253	1/6	0,7		1-0-6-0-0 / 6
10255	1/9	0,7		1-0-6-0-0 / 6

Tapa GN cierre hermético

GN hermetic lid - Couvercle étanche GN - Coperchio ermetico GN - GN-steck-deckell

NEW



REF.	GN	e(mm)	€	UE / MOQ
10258	1/1	0,7		1-0-6-0-0 / 6
10259	1/2	0,7		1-0-6-0-0 / 6
10260	1/3	0,7		1-0-6-0-0 / 6
10261	1/4	0,7		1-0-6-0-0 / 6
10262	1/6	0,7		1-0-6-0-0 / 6

Tapa GN orificio asas

GN lid with hole for handles - Couvercle GN avec trou pour poignées - Coperchio GN con foro per maniglie - GN-deckel Lock für Griffe

NEW



REF.	GN	e(mm)	€	UE / MOQ
10263	1/1	0,7		1-0-6-0-0 / 6
10265	1/2	0,7		1-6-12-0-0 / 6
10266	1/3	0,7		1-6-18-0-0 / 6
10267	1/4	0,7		1-6-24-0-0 / 6
10268	1/6	0,7		1-6-36-0-0 / 6

Tapa GN orificio cucharón

GN lid with ladle hole - Couvercle GN avec trou pour louche - Coperchio GN con foro mestolo - GN-deckel loch kelle 1/1

NEW



REF.	GN	e(mm)	€	UE / MOQ
10269	1/1	0,7		1-0-6-0-0 / 6
10270	1/2	0,7		1-6-12-0-0 / 6
10271	1/3	0,7		1-6-18-0-0 / 6
10272	1/4	0,7		1-6-24-0-0 / 6
10273	1/6	0,7		1-6-36-0-0 / 6

Tapa GN sin asa

GN flat lid without handle - Couvercle plat GN sans poignée - Coperchio piatto GN senza manico - GN-Flachdeckel ohne Griff

NEW



REF.	GN	e(mm)	€	UE / MOQ
10256	1/1	0,7		1-0-6-0-0 / 6
10257	1/2	0,7		1-0-6-0-0 / 6



Apto horno.
Oven save.



Apto lavavajillas.
Dishwasher save.



Apilable.
Stackable.



-20°C
300 °C



Apto contacto
alimentario.
Food contact save.

COMPATIBLE CON
LAS PRINCIPALES
MARCAS DEL
MERCADO
COMPATIBLE WITH ALL
MAJOR BRANDS ON THE
MARKET



USO
RECOMENDADO
EN BUFFET

RECOMMENDED
BUFFET USE



Medida estampada en la esquina
Measurement stamped on the corner

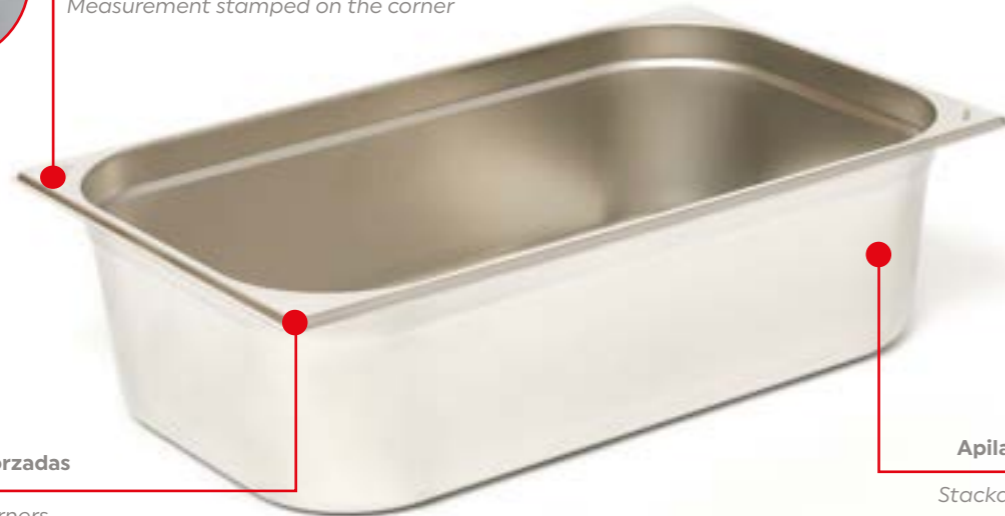

Esquinas reforzadas
reinforced corners

Apilable
Stackable



Modelo perforado perfecto para el
drenaje de líquidos y cocción al va-
por.

Perforated model perfect for drain-
ing liquids and steaming.

GN 1/1 - 325 X 530 mm



REF.	H(mm)	e(mm)	LT	€	UE / MOQ
10566	20	0,7			1-0-6-24-264 / 6
10567	40	0,7			1-0-6-24-264 / 6
10568	55	0,7			1-0-6-24-192 / 6
10569	65	0,8	8,8		1-0-6-24-192 / 6
10839	65	0,7	8,8		1-0-6-24-120 / 6
10570	100	0,7	13,7		1-0-6-24-120 / 6
10571	150	0,7	20		1-0-6-24-120 / 6
10572	200	0,7	27,8		1-0-6-24-96 / 6

GN 1/2 - 265 X 325 mm



REF.	H(mm)	e(mm)	LT	€	UE / MOQ
10573	20	0,7			1-6-12-48-528 / 6
10574	40	0,7			1-6-12-48-528 / 6
10575	65	0,7	4		1-6-12-48-336 / 6
10576	100	0,7	6,1		1-6-12-48-240 / 6
10577	150	0,7	9,2		1-6-12-48-192 / 6
10578	200	0,7	12		1-6-12-48-144 / 6

GN 1/3 - 176 X 325 mm



REF.	H(mm)	e(mm)	LT	€	UE / MOQ
10579	20	0,7			1-6-18-72-360 / 6
10580	40	0,7			1-6-18-72-360 / 6
10581	65	0,7	2,4		1-6-18-72-26 / 6
10582	100	0,7	3,5		1-6-18-72-144 / 6
10583	150	0,7	5,4		1-6-18-72-144 / 6
10584	200	0,7	7,2		1-6-18-72-144 / 6

GN 1/4 - 162 X 265 mm



REF.	H(mm)	e(mm)	LT	€	UE / MOQ
10585	20	0,7			1-6-24-96-480 / 6
10586	40	0,7			1-6-24-96-480 / 6
10587	65	0,7	1,7		1-6-24-72-216 / 6
10588	100	0,7	2,5		1-6-24-96-192 / 6
10589	150	0,7	3,8		1-6-24-96-192 / 6
10590	200	0,7	4,8		1-6-24-96-96 / 6



Certificado
contacto
alimentario.



-20°C
300 °C



GN 1/6 - 162 X 176 mm



REF.	H(mm)	e(mm)	LT	€	UE / MOQ
10591	65	0,7	1		1-6-36-0-0 / 6
10592	100	0,7	1,5		1-6-36-0-0 / 6
10593	150	0,7	2,3		1-6-36-0-0 / 6
10594	200	0,7	3,3		1-6-36-0-0 / 6

GN 1/9 - 108 X 176 mm



REF.	H(mm)	e(mm)	LT	€	UE / MOQ
10595	65	0,7	0,6		1-6-48-0-0 / 6
10596	100	0,7	0,8		1-6-48-0-0 / 6

GN 1/1 Perforada - Perforated - Perforé - Forate - Perforiert - 325 x 530 mm



REF.	H(mm)	e(mm)	€	UE / MOQ
10617	65	0,7		1-0-6-0-0 / 6
10618	100	0,7		1-0-6-0-0 / 6
10619	150	0,7		1-0-6-0-0 / 6
10620	200	0,7		1-0-6-0-0 / 6

GN 1/2 Perforada - Perforated - Perforé - Forate - Perforiert - 265 X 325 mm



REF.	H(mm)	e(mm)	€	UE / MOQ
10621	65	0,7		1-6-12-0-0 / 6
10622	100	0,7		1-6-12-0-0 / 6

Tapa GN inox
GN lid - Couvercle GN - Coperchio GN - GN-deckel



INOX STAINLESS STEEL 201

REF.	GN	e _(mm)	€	UE / MOQ
10630	1/1	0,7		1-0-6-0-0 / 6
10632	1/2	0,7		1-6-12-0-0 / 6
10633	1/3	0,7		1-6-18-0-0 / 6
10634	1/4	0,7		1-6-24-0-0 / 6
10635	1/6	0,7		1-6-36-0-0 / 6
10636	1/9	0,7		1-6-48-0-0 / 6

Tapa GN cierre hermético
GN hermetic lid - Couvercle étanche GN - Coperchio ermetico GN - GN-steck-deckell

Válvula para facilitar la apertura.

Valve for easy opening.



INOX STAINLESS STEEL 201

REF.	GN	e _(mm)	€	UE / MOQ
10637	1/1	0,7		1-0-6-0-0 / 6
10638	1/2	0,7		1-6-12-0-0 / 6
10639	1/3	0,7		1-6-18-0-0 / 6
10640	1/4	0,7		1-6-24-0-0 / 6
10641	1/6	0,7		1-6-36-0-0 / 6

INOX STAINLESS STEEL 201

Doble fondo perforado
Perforated bottom
Egouttoirs pour bacs
Falso fondo forato
Abtropfgitter



REF.	FORMATO	e _(mm)	€	UE / MOQ
10612	GN 1/1	0,7		1-0-10-0-0 / 10

INOX STAINLESS STEEL 201

Perfil divisorio GN
Adaptable bars
Barrettes de composition
Separatore
Adapter



REF.	FORMATO	e _(mm)	€	UE / MOQ
10614	GN 1/1	0,7		1-0-120-0-0 / 12
10615	GN 1/2	0,7		1-0-120-0-0 / 12

Rueda de untar inox

Stainless steel spread wheel
Roue tartiner en acier inoxydable
Ruota per spalmare in acciaio inossidabile
Butterrad aus Edelstahl



REF.	W _(mm)	L _(mm)	H _(mm)	€
11602	160	175	125	

Parrilla horno pastelera
Pastry oven grill 60x40
Gril au four pâtisserie 60x40
Griglia forno pasticceria 60x40
Backofengrill 60x40

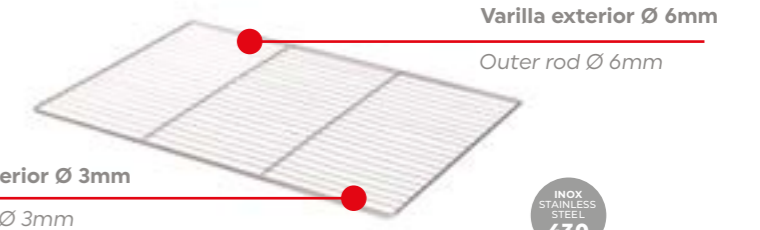

Varilla interior Ø 3mm
Inner rod Ø 3mm

Varilla exterior Ø 6mm
Outer rod Ø 6mm

INOX STAINLESS STEEL 430

REF.	W _(mm)	L _(mm)	€	UE / MOQ
11014	600	400		1-6-12-0-0 / 6

Parrilla horno GN 1/1
Oven grill gn 1/1
Gril au four gn 1/1
Griglia forno gn 1/1
Backofengrill gn 1/1

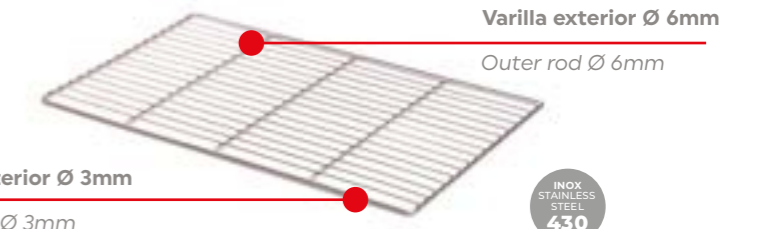

Varilla interior Ø 3mm
Inner rod Ø 3mm

Varilla exterior Ø 6mm
Outer rod Ø 6mm

INOX STAINLESS STEEL 430

REF.	W _(mm)	L _(mm)	€	UE / MOQ
11015	325	530		1-6-12-0-0 / 6



NEW

Carro Servicio
Serving Trolley
Chariot Service
Carrello Da Servizio
Servierwagen

INOX STAINLESS STEEL 201

REF.	LEVELS	W _(mm)	L _(mm)	H _(mm)	€	UE / MOQ
11774	2	860	540	940		0-0-1-0-0 / 1
11775	3	860	540	940		0-0-1-0-0 / 1

NEW

Carro Racks Alto
Rack Trolley High
Chariot À Rack Élevé
Carrello Rack Alto
Hoher Tablettwagen Für



INOX STAINLESS STEEL 201

REF.	LEVELS	W _(mm)	L _(mm)	H _(mm)	€	UE / MOQ
11773	7	510	1700	560		0-0-1-0-0 / 1



NEW

GN / Carros
GN / Trolley



Ruedas pivotantes con freno en 2 de ellas.

Swivel castors with brakes on 2 of them.



Guía en "S", que permite una doble posición de las bandejas y mayor optimización del espacio.

S' guide, which allows double positioning of the trays and greater optimisation of space.



Varilla de seguridad bilateral para bloquear las bandejas.

Safety rod on the side to lock the trays.



GN 1/1

18 NIVELES
18 LEVELS



GN 1/1

9 NIVELES
9 LEVELS



GN 2/1

18 NIVELES
18 LEVELS



60x40 CM

18 NIVELES
18 LEVELS

● **Ligeros. Fabricados en acero inoxidable AISI 201.**
Lightweight. Made of AISI 201 stainless steel.

● **Resistentes. Soportan hasta 150 kg.**
Resistant. Supports up to 150 kg.

● **Fácil montaje.**
Easy assembly.

Carro Portabandejas Gn
Gn Container Trolley
Chariot Porte-Plateaux Gn
Carrello Portavassoi Gn
Gn-Tablett-/Regalwagen

INOX
STAINLESS
STEEL
201

REF.	SIZE	LAYERS	W(mm)	L(mm)	H(mm)	€	UE / MOQ
11769	GN 1/1	18	380	550	1735		0-0-1-0-0 / 1
11956	GN 1/1	9	380	550	1000		0-0-1-0-0 / 1
11770	GN 2/1	18	590	670	1735		0-0-1-0-0 / 1
11771	60x40	18	470	620	1735		0-0-1-0-0 / 1



336 RACKS

- 336 CESTAS Y EXTENDERS
- 338 MONTADOS
- 340 COMPLEMENTOS

342 CONTENEDORES ISOTÉRMICOS

THERMOBOX

- 344 CARGADOR FRONTAL
- 347 CONTENEDORES



Racks industriales robustos para lavar, almacenar y transportar cualquier tipo de plato, vaso, copa, cubertería, etc.

El borde superior y la forma de los fondos están hechos para apilarlos de forma fácil y firme.

Los extensores permiten alcanzar la altura ideal para el almacenamiento y lavado.

Robust industrial racks for washing, storing and transporting any type of plate, glass, cup, glassware, cutlery, etc.

The top edge and the shape of the bottoms are made for easy and firm stacking.

The extenders allow to reach the ideal height for storage and washing.



Fabricado en PP de alta calidad, apto para contacto alimentario, el mejor material contra productos químicos y altas temperaturas (hasta 100°C)

Made of high quality PP, suitable for food contact, the best material against chemicals and high temperatures (up to 100°C)

Rejillas abiertas para un perfecto lavado y secado

Open grids for perfect washing and drying

Las asas y las esquinas redondeadas, lo hacen seguro y fácil de manejar

Easily to handle four sides.

El borde superior y la forma de los fondos están hechos para apilarlos de forma fácil y firme

The top edge and the shape of the bottoms are made for easy and firm stacking

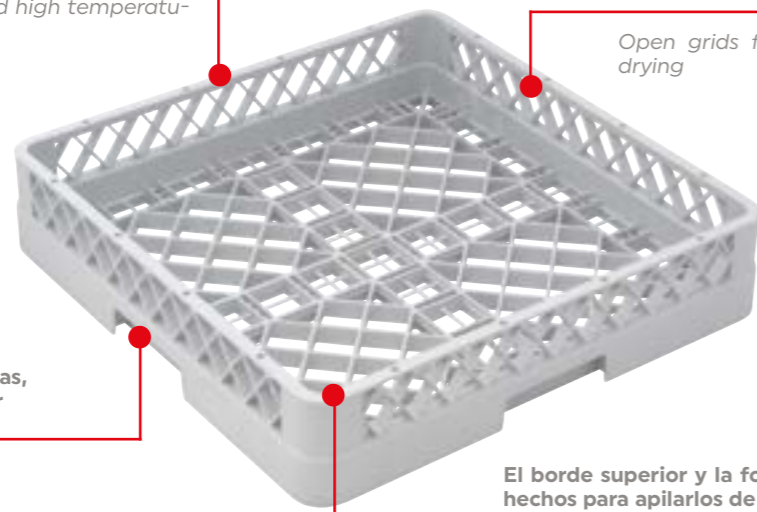

Racks.



Cesta de lavado universal

Universal rack
Universal rack
Rack universale
Universal rack



REF.	MEDIDA EXTERNA		MEDIDA INTERNA		€	UE / MOQ
	W(mm)	L(mm)	W(mm)	L(mm)		
11039	500	500	476	476		1-0-6-0-0 / 6

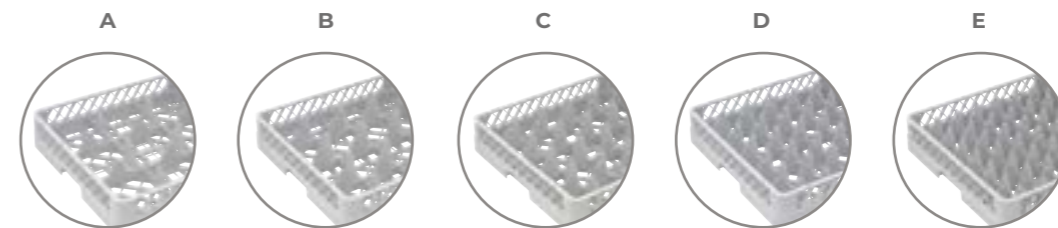

Cesta de lavado compartimento / Rack compartiment / Rack compartiment / Rack scomparto / Rack fächer

REF.	MEDIDA EXTERNA		MEDIDA INTERNA		COMPARTIMENTOS	€	UE / MOQ
	W(mm)	L(mm)	W(mm)	L(mm)			
A 11040	500	500	151	151	9		1-0-6-0-0 / 6
B 11041	500	500	115	115	16		1-0-6-0-0 / 6
C 11042	500	500	88	88	25		1-0-6-0-0 / 6
D 11043	500	500	73	73	36		1-0-6-0-0 / 6
E 11044	500	500	62	62	49		1-0-6-0-0 / 6

Extender universal

Universal extender
Universal extender
Extender universale
Universal extender



REF.	MEDIDA EXTERNA		MEDIDA INTERNA		€	UE / MOQ
	W(mm)	L(mm)	W(mm)	L(mm)		
11048	500	500	476	476		1-0-12-0-0 / 12

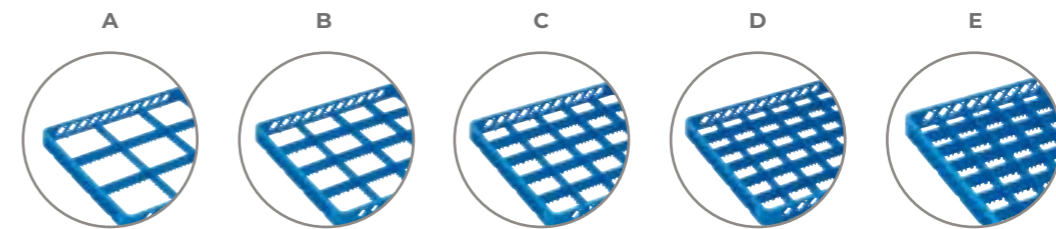

Extender compartimentos / Extender compartiment / Extender compartimen / Extender scomparto / Extender fächer

REF.	MEDIDA EXTERNA		MEDIDA INTERNA		COMPARTIMENTOS	€	UE / MOQ
	W(mm)	L(mm)	W(mm)	L(mm)			
A 11049	500	500	151	151	9		1-0-12-0-0 / 12
B 11050	500	500	115	115	16		1-0-12-0-0 / 12
C 11051	500	500	88	88	25		1-0-12-0-0 / 12
D 11052	500	500	73	73	36		1-0-12-0-0 / 12
E 11053	500	500	62	62	49		1-0-12-0-0 / 12



4 EXT. 256 mm

3 EXTENDERS. 214 mm

2 EXTENDERS. 172 mm

1 EXTENDER. 130 mm

BASE RACK. 88 mm

GUÍA DE MEDIDAS / GUIDE TO MEASURE

- Monta tu propia altura según tus necesidades.
Set your own height according to your needs.
- Fácil sistema de montaje y que permite adaptar los racks a tus productos.
Easy assembly system that allows you to adapt the racks to your products.
- Se pueden añadir tantos suplementos como se desee.
You can add as many supplements as you wish.
- Una vez montados no se pueden desmontar.
Once assembled, they cannot be disassembled.

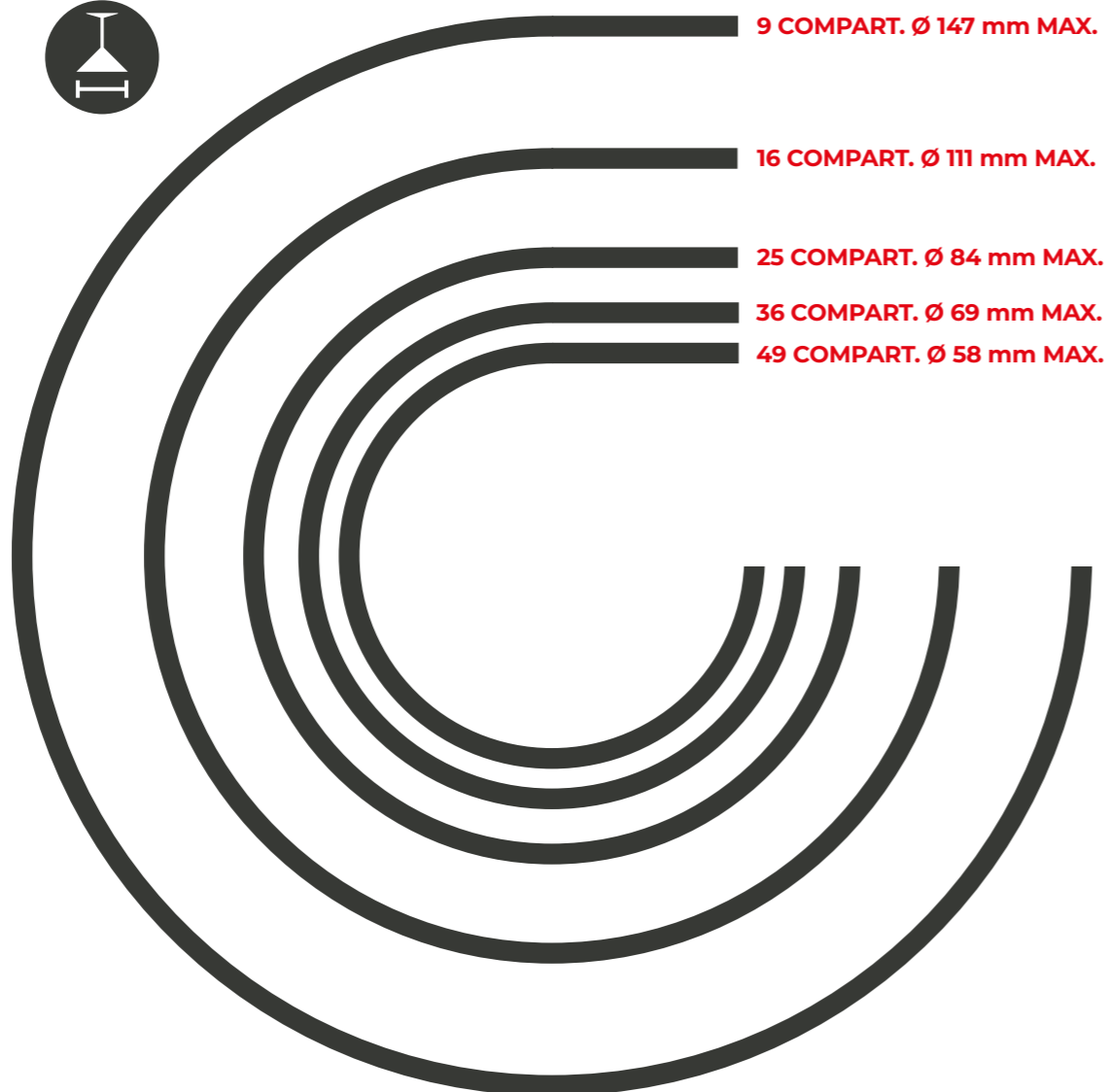

Ø 147mm MAX.

PACK cestas de lavado 9 compartimentos

PACK rack 9 compartment
PACK rack 9 compartment
PACK rack 9 scomparto
PACK rack 9 fächer



REF.	EXTENDER	ALTURA	€	UE / MOQ
11145	+1	130		1-0-6-0-0 / 6
11146	+2	172		1-0-6-0-0 / 6
11147	+3	214		1-0-6-0-0 / 6
11148	+4	256		1-0-6-0-0 / 6
11149	+5	298		1-0-6-0-0 / 6



Ø 84mm MAX.

PACK cestas de lavado 25 compartimentos

PACK rack 25 compartment
PACK rack 25 compartment
PACK rack 25 scomparto
PACK rack 25 fächer



REF.	EXTENDER	ALTURA	€	UE / MOQ
11155	+1	130		1-0-6-0-0 / 6
11156	+2	172		1-0-6-0-0 / 6
11157	+3	214		1-0-6-0-0 / 6
11158	+4	256		1-0-6-0-0 / 6
11159	+5	298		1-0-6-0-0 / 6



Ø 58mm MAX.

PACK cestas de lavado 49 compartimentos

PACK rack 49 compartment
PACK rack 49 compartment
PACK rack 49 scomparto
PACK rack 49 fächer



REF.	EXTENDER	ALTURA	€	UE / MOQ
11165	+1	130		1-0-6-0-0 / 6
11166	+2	172		1-0-6-0-0 / 6
11167	+3	214		1-0-6-0-0 / 6
11168	+4	256		1-0-6-0-0 / 6
11169	+5	298		1-0-6-0-0 / 6



Ø 111mm MAX.

PACK cestas de lavado 16 compartimentos

PACK rack 16 compartment
PACK rack 16 compartment
PACK rack 16 scomparto
PACK rack 16 fächer



REF.	EXTENDER	ALTURA	€	UE / MOQ
11150	+1	130		1-0-6-0-0 / 6
11151	+2	172		1-0-6-0-0 / 6
11152	+3	214		1-0-6-0-0 / 6
11153	+4	256		1-0-6-0-0 / 6
11154	+5	298		1-0-6-0-0 / 6



Ø 69mm MAX.

PACK cestas de lavado 36 compartimentos

PACK rack 36 compartment
PACK rack 36 compartment
PACK rack 36 scomparto
PACK rack 36 fächer



REF.	EXTENDER	ALTURA	€	UE / MOQ
11160	+1	130		1-0-6-0-0 / 6
11161	+2	172		1-0-6-0-0 / 6
11162	+3	214		1-0-6-0-0 / 6
11163	+4	256		1-0-6-0-0 / 6
11164	+5	298		1-0-6-0-0 / 6

Pack 10 clips para cestas

Pack 10 rack clip
Pack 10 rack clip
Pack 10 rack clip
Pack 10 rack clip



REF.	COLOR	W(mm)	L(mm)	€	UE / MOQ
11059	○	20	0,7		1-0-100-0-0 / 100
11060	●	20	0,7		1-0-100-0-0 / 100
11061	●	20	0,7		1-0-100-0-0 / 100
11062	●	20	0,7		1-0-100-0-0 / 100
11063	●	20	0,7		1-0-100-0-0 / 100
11064	●	20	0,7		1-0-100-0-0 / 100
11065	●	20	0,7		1-0-100-0-0 / 100



Cesta de lavado para cubertería
 Rack for cutlery
 Rack pour les couverts
 Rack per posate
 Rack für besteck



REF.	W(mm)	L(mm)	€	UE / MOQ
11045	500	500		1-0-6-0-0 / 6

Cesta de lavado para bandejas
 Rack for trays
 Rack pour plateaux
 Rack per vassoio
 Rack für tablett



REF.	W(mm)	L(mm)	€	UE / MOQ
11046	500	500		1-0-6-0-0 / 6

Cesta de lavado para vajilla
 Rack for plates
 Rack pour les plats
 Rack per piatti
 Rack für teller



REF.	W(mm)	L(mm)	€	UE / MOQ
11047	500	500		1-0-6-0-0 / 6

Tapa para cesta de lavado
 Rack lid
 Rack couvercle
 Rack coperchio
 Rack deckel



REF.	W(mm)	L(mm)	€	UE / MOQ
11076	500	500		1-0-12-0-0 / 12

Cesta para cubertería
 Rack for cutlery
 Rack pour les couverts
 Rack per posate
 Rack für besteck



REF.	W(mm)	L(mm)	COMPARTIMENTOS	€	UE / MOQ
11055			1		1-0-150-0-0 / 150
11054	430	205	8		1-0-10-0-0 / 10

Asa para cesta cubertería
 Handle for rack for cutlery
 Poignée pour rack pour les couverts
 Manico per rack per posate
 Griff für rack für besteck



REF.	W(mm)	L(mm)	€	UE / MOQ
11079	500	500		1-0-10-0-0 / 10

Carro para cesta de lavado sin asa
 Rack trolley without handle
 Rack chariot sans poignée
 Rack carrello senza maniglia
 Rack wagen ohne griff



REF.	W(mm)	L(mm)	€	UE / MOQ
11077	500	500		1-0-1-0-0 / 1

Carro para cesta de lavado con asa
 Rack trolley with handle
 Rack chariot avec poignée
 Rack carrello con maniglia
 Rack wagen mit griff



REF.	W(mm)	L(mm)	€	UE / MOQ
11078	500	500		1-0-1-0-0 / 1



INOX
 STAINLESS
 STEEL
 201

Carro Racks Alto
 Rack Trolley High
 Chariot À Rack Élevé
 Carrello Rack Alto
 Hoher Tablettwagen Für



REF.	CAPACIDAD	W(mm)	L(mm)	H(mm)	€	UE / MOQ
11773	7	560	510	1735		1-0-6-0-0 / 6

Especial para lavavajillas de barra.
 Specially for countertop dishwashers

Rack 35,5 x 35,5
 Rack
 Rack
 Rack
 Rack



REF.	W(mm)	L(mm)	H(mm)	€	UE / MOQ
11616	355	355	150		1-0-6-0-0 / 6

Rack 40 x 40
 Rack
 Rack
 Rack
 Rack



REF.	W(mm)	L(mm)	H(mm)	€	UE / MOQ
11617	400	400	150		1-0-6-0-0 / 6



Empresa alemana fundada en 2001. Líder del mercado europeo con más de 100 cajas de EPP diferentes para el transporte de productos frescos, calientes o fríos.

German company founded in 2001. European market leader with more than 100 different EPP boxes for the transport of fresh, hot or cold products.



Asa resistente para transportarla con una sola mano.

Sturdy handle for carrying with one hand.

Caja térmica adecuada que encaja perfectamente y es fácil de usar.

Proper cool box that fits perfectly and is easy to use.

Tapa hermética fácil de abrir y cerrar.

Airtight lid easy to open and close.





GN / Cargador frontal
GN / Frontloader

Construcción sólida de una sola pieza

Solid one-piece construction

Forma compacta

Compact design

Puerta abatible

Hinged door



Borde de agarre práctico
Handy grip edges

Apilable y ligero
Stackable and lightweight

Cierres y bisagras metálicos
Metal locking and hinges

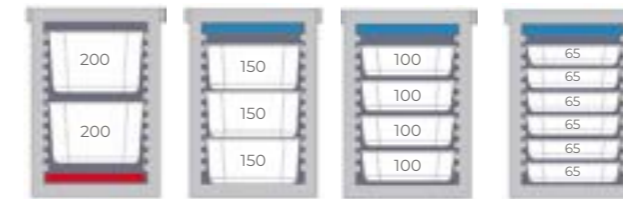

CIERRE METÁLICO REFORZADO
REINFORCED METAL LOCKING



Contenedor isotérmico carga frontal GN 93-12
Thermobox frontloader GN 93-12
Conteneur isotherme à ouverture frontale GN 93-12
Contentitore isothermico per carico frontale GN 93-12
Thermobox frontlader GN 93-12

REF.	COLOR	OUTSIDE			INSIDE			CARRILES(mm)	V(litros)	€
		W(mm)	L(mm)	H(mm)	W(mm)	L(mm)	H(mm)			
10416	●	440	645	625	335	530	525	12 - 32	93	

Set Rueda + Base

Wheels + Base Set
Kit Roue + Base
Set Ruota+ Base
Set Rad + Base



REF.	W(mm)	L(mm)	H(mm)	€
11762	400	600	180	



Contenedor isotérmico carga frontal GN 69-9
Thermobox frontloader GN 69-9
Conteneur isotherme à ouverture frontale GN 69-9
Contentitore isothermico per carico frontale GN 69-9
Thermobox frontlader GN 69-9

REF.	COLOR	OUTSIDE			INSIDE			CARRILES(mm)	V(litros)	€
		W(mm)	L(mm)	H(mm)	W(mm)	L(mm)	H(mm)			
10417	●	450	660	490	335	530	390	9 - 38	69	

Set Rueda + Base
Wheels + Base Set
Kit Roue + Base
Set Ruota+ Base
Set Rad + Base

REF.	W(mm)	L(mm)	H(mm)	€
11763	400	600	180	



GN
SIZE

Contenedor isotérmico GN 1/1 PREMIUM
Thermobox GN 1/1 PREMIUM
Conteneur isotherme GN 1/1 PREMIUM
Contentitore isothermico GN 1/1 PREMIUM
Thermobox GN 1/1 PREMIUM

REF.	W(mm)	OUTSIDE		H(mm)	INSIDE		V(litros)	€
		L(mm)	H(mm)		W(mm)	L(mm)		
10409	400	600	180	337	538	117	21	
10410	400	600	230	337	538	167	30	
10411	400	600	280	337	538	217	39	
10412	400	600	320	337	538	257	46	
10413	400	600	400	337	538	337	61	

Cooling Top Gn 1/1 Premium
Cooling Top Gn 1/1 Premium
Plaque Réfrigérante Gn 1/1 Premium
Piano Di Raffreddamento Gn 1/1 Premium
Gn-Kühlaufsatz 1/1 Premium

REF.	W(mm)	L(mm)	H(mm)	€
11764	400	600	180	



GN
SIZE

Contenedor isotérmico GN 1/1 DELUXE
Thermobox GN 1/1 DELUXE
Conteneur isotherme GN 1/1 DELUXE
Contentitore isothermico GN 1/1 DELUXE
Thermobox GN 1/1 DELUXE

REF.	W(mm)	OUTSIDE		H(mm)	INSIDE		V(litros)	€
		L(mm)	H(mm)		W(mm)	L(mm)		
10414	400	675	290	325	535	215	37	
10415	400	675	335	325	535	260	45	



Cooling Top Gn 1/1 Deluxe
Cooling Top Gn 1/1 Deluxe
Plaque Réfrigérante Gn 1/1 Deluxe
Piano Di Raffreddamento Gn 1/1 Deluxe
Gn-Kühlaufsatz 1/1 Deluxe

REF.	W(mm)	L(mm)	H(mm)	€
11765	400	600	180	



Placa de calor
Hot Pack
Plaque chauffante
Piastra riscaldante
Wärme-akku

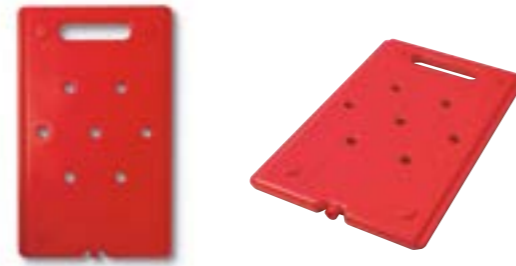

REF.	W(mm)	L(mm)	H(mm)	FORMATO	€
10423	325	530	25	GN 1/1	

Calentamiento en el horno (max. 30min a 85°C) y baño maría (max. 30min).
Heating in the oven (max. 30min at 85°C), microwave and bain-marie (max. 30min).

Placa de frío
Cold pack
Plaque eutectique
Piastra eutetica
Kühl-akku

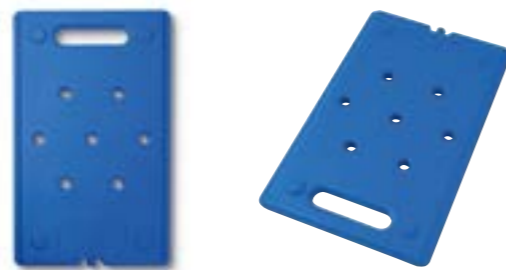

REF.	W(mm)	L(mm)	H(mm)	FORMATO	€
10424	325	530	25	GN 1/1	

Refrigeración en el congelador (max. -12°C).
Cooling in the freezer (max. -12°C).



Contenedor isotérmico SHOPPING
Thermobox SHOPPING
Conteneur isotherme SHOPPING
Contentitore isotermico SHOPPING
Thermobox SHOPPING

REF.	COLOR	W(mm)	OUTSIDE L(mm)	H(mm)	W(mm)	INSIDE L(mm)	H(mm)	FORMATO	V(litros)	€
10420	●	285	360	365	220	300	310	GN 1/4	20	

Caja para las mejores soluciones logísticas. Tamaño de embalaje optimizado, apilable con los contenedores más comunes, adecuado para contenedores de tamaño GN.

Box for best logistical solutions! Optimized packaging size, stackable with most common stacking containers, suitable for GN size containers.



Contenedor isotérmico BOXER
Thermobox BOXER
Conteneur isotherme BOXER
Contentitore isotermico BOXER
Thermobox BOXER



REF.	W(mm)	OUTSIDE L(mm)	H(mm)	W(mm)	INSIDE L(mm)	H(mm)	V(litros)	€
10422	395	595	290	340	540	230	42	

Tamaño cuadrado optimizado. Con asas empotradas y tapa hermética. Para recipientes GN 2/3, pizza o pasteles.

Optimized square size. With recessed grips, tight fitting lid. For containers GN 2/3, pizza or cakes.



Contenedor isotérmico pizza BOXER
Thermobox pizza BOXER
Conteneur isotherme pizza BOXER
Contentitore isotermico pizza BOXER
Thermobox pizza BOXER



REF.	W(mm)	OUTSIDE L(mm)	H(mm)	W(mm)	INSIDE L(mm)	H(mm)	V(litros)	€
10421	400	415	265	350	365	210	27	

Contenedor isotérmico ALLROUND 60/40
Thermobox ALLROUND 60/40
Conteneur isotherme ALLROUND 60/40
Contentitore isotermico ALLROUND 60/40
Thermobox ALLROUND 60/40



REF.	W(mm)	OUTSIDE L(mm)	H(mm)	W(mm)	INSIDE L(mm)	H(mm)	V(litros)	€
10418	485	660	260	425	625	200	53	
10419	485	685	360	425	625	300	80	



- Base llana y robusta de 350 x 350 mm sin bordes.
Sturdy, flat base 350 x 350 mm without edges.
- Cierre seguro.
Secure locking.
- Superficie antideslizante.
Non-slip surface.

- Apilable con otros contenedores.
Stackable with other containers.
- Sistema de bloqueo en la base.
Locking system at the base.



Cake Box

Cake Box
Boîte À Gâteau
Scatola Per Torta
Kuchenvitrine

REF.	OUTSIDE			INSIDE			V (litros)	€
	W (mm)	L (mm)	H (mm)	W (mm)	L (mm)	H (mm)		
11766	400	415	280	350	350	175	21	



Extender Cake Box

Extender Cake Box
Extension Boîte À Gâteau Noir
Estensore Per Scatola Torta
Erweiterung Kuchenvitrine

REF.	OUTSIDE			INSIDE			V (litros)	€
	W (mm)	L (mm)	H (mm)	W (mm)	L (mm)	H (mm)		
11767	410	410	135	350	350	120		



SALA

DINING ROOM

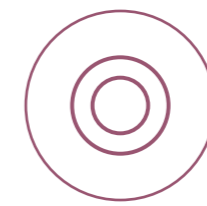

354 VAJILLA / TABLEWARE

- 354 PLAISIR
- 360 DIM SUM
- 362 PEANA
- 364 AMBAR

368 PRESENTACIÓN / PRESENTATION

- 368 BAUHAUS
- 374 TABLAS PRESENTACIÓN

376 MINIATURAS / MINIATURES

- 376 INOX Y COBRE
- 378 INOX
- 380 FREIDORAS
- 381 PAPEL ANTIGRASA
- 382 HIERRO FUNDIDO
- 384 HIERRO ESMALTADO
- 388 MADERA HAYA
- 390 VAPOERAS

392 SERVICIO MESA / TABLE TOP

- 392 CHAMPAGNERAS
- 396 PANERAS
- 400 VINAGRERAS
- 402 ACCESORIOS

Plaisir



Plaisir
Vajilla / Tableware



La colección PLAISIR está compuesta de platos de porcelana perfectos para servir pequeñas porciones de alimentos, lo que permite una presentación elegante y cuidada de las elaboraciones. Su belleza realza la apariencia de los alimentos, convirtiendo una simple porción de comida en una experiencia culinaria especial.

PLAISIR puede ser utilizado para crear composiciones visuales atractivas en la mesa, combinando diferentes colores y diseños para lograr una estética única. Además, suelen ser parte integral de la vajilla de alta gama, aportando un toque de lujo y sofisticación a cualquier evento o comida.

The PLAISIR collection is composed of porcelain plates that are perfect for serving small portions of food, allowing for an elegant and carefully prepared presentation of food. Its beauty enhances the appearance of the food, turning a simple portion of food into a special culinary experience.

PLAISIR can be used to create attractive visual compositions on the table, combining different colours and patterns to achieve a unique aesthetic. In addition, they are often an integral part of high-end tableware, bringing a touch of luxury and sophistication to any event or meal.



PLAISIR
Collection.





PLAISIR 1.1

REF.	COLOR	L _(mm)	W _(mm)	H _(mm)	€	UE / MOQ
10668	NEGRO	101	82	42		1-4-72 / 4
10879	BLANCO	101	82	42		1-4-72 / 4



PLAISIR 1

REF.	COLOR	L _(mm)	W _(mm)	H _(mm)	€	UE / MOQ
10669	NEGRO	81	70	34		1-4-72 / 4
10880	BLANCO	81	70	34		1-4-72 / 4



PLAISIR 2

REF.	COLOR	L _(mm)	W _(mm)	H _(mm)	€	UE / MOQ
10670	NEGRO	124	93	35		1-4-72 / 4
10881	BLANCO	124	93	35		1-4-72 / 4



PLAISIR 3

REF.	COLOR	L _(mm)	W _(mm)	H _(mm)	€	UE / MOQ
10671	NEGRO	134	55	21		1-4-72 / 4
10882	BLANCO	134	55	21		1-4-72 / 4



PLAISIR 4

REF.	COLOR	L _(mm)	W _(mm)	H _(mm)	€	UE / MOQ
10672	NEGRO	116	71	31		1-4-72 / 4
10883	BLANCO	116	71	31		1-4-72 / 4



PLAISIR 5

REF.	COLOR	L _(mm)	W _(mm)	H _(mm)	€	UE / MOQ
10673	NEGRO	164	118	43		1-4-72 / 4
10884	BLANCO	164	118	43		1-4-72 / 4

PLAISIR 6



REF.	COLOR	L _(mm)	W _(mm)	H _(mm)	€	UE / MOQ
10674	NEGRO	129	83	39		1-4-72 / 4
10885	BLANCO	129	83	39		1-4-72 / 4



PLAISIR 4 XL

REF.	COLOR	L _(mm)	W _(mm)	H _(mm)	€	UE / MOQ
10958	NEGRO	240	145	65		1-4-24 / 4
10960	BLANCO	240	145	65		1-4-24 / 4



PLAISIR 7

REF.	COLOR	L _(mm)	W _(mm)	H _(mm)	€	UE / MOQ
10675	NEGRO	125	114	26		1-4-72 / 4
10886	BLANCO	125	114	26		1-4-72 / 4



PLAISIR 5 XL

REF.	COLOR	L _(mm)	W _(mm)	H _(mm)	€	UE / MOQ
10959	NEGRO	247	230	30		1-4-32 / 4
10961	BLANCO	247	230	30		1-4-32 / 4

PLAISIR 8



REF.	COLOR	L _(mm)	W _(mm)	H _(mm)	€	UE / MOQ
10676	NEGRO	124	80	33		1-4-72 / 4
10887	BLANCO	124	80	33		1-4-72 / 4



Dim Sum S



REF.	Ø(mm)	€	UE / MOQ
11588	128		1-1-18-0-0 - 1

Dim Sum L



REF.	Ø(mm)	€	UE / MOQ
11590	186		1-1-2-0-0 / 1



Peana blanca

Base white
Base blanc
Base bianca
Basis weiss

REF.	Ø(mm)	H(mm)	€	UE / MOQ
11591	155	84		1-3-24-0-0 / 3



Peana negra

Base black
Base noir
Base nera
Base schwarz

REF.	Ø(mm)	H(mm)	€	UE / MOQ
11592	155	84		1-3-24-0-0 / 3



Peana oval blanca

Base oval white
Base ovale blanc
Base ovale bianca
Basis ovale weiss

REF.	L(mm)	W(mm)	H(mm)	€	UE / MOQ
11593	309	168	88		1-3-9-0-0 / 3





Conoce UTSET en la página: 504
More about UTSET in page: 504



Bol cristal
Glass bowl
Bol en verre
Ciotola in vetro
Kristallkugel



REF.	Ø(mm)	H(mm)	€	UE / MOQ
10788	190	45		0-4-16-0-0 / 4

Base Cristal L
Glass Dish Amber L
Assiette En Verre L
Piatto In Vetro L
Glasteller L



REF.	L(mm)	W(mm)	€	UE / MOQ
10792	270	170		0-4-24-0-0 / 4

Base Cristal S
Glass Dish Amber S
Assiette En Verre S
Piatto In Vetro S
Glasteller S



REF.	L(mm)	W(mm)	€	UE / MOQ
10794	120	120		0-4-96-0-0 / 4

NEW

Soporte Snacks Cristal Cuadrado
Glass Square Snack Stand
Support En-Cas En Verre
Supporto Snacks In Vetro
Basso Snack-Theke Glas



REF.	SIZE	L(mm)	W(mm)	H(mm)	€	UE / MOQ
11798	BAJO	120	105	30		0-4-32-0-0 / 4
11799	ALTO	115	115	50		0-4-32-0-0 / 4

Bol cristal
Glass bowl
Bol en verre
Ciotola in vetro
Kristallkugel



REF.	Ø(mm)	H(mm)	€	UE / MOQ
10789	150	40		0-4-48-0-0 / 4

Base Cristal M
Glass Dish Amber M
Assiette En Verre M
Piatto In Vetro M
Glasteller M



REF.	L(mm)	W(mm)	€	UE / MOQ
10793	120	240		0-4-48-0-0 / 4

Soporte snacks mini
Glass Mini Snack Stand
Support En-Cas En Verre Mini
Supporto Snacks In Vetro Mini
Snack-Theke Mini



REF.	L(mm)	W(mm)	€	UE / MOQ
11797	150	50		0-4-72-0-0 / 4

Soporte tacos cristal doble
Double glass support
Support double verre
Supporto vetro doppio
Doppelte glshalterung



REF.	L(mm)	H(mm)	W(mm)	€	UE / MOQ
10791	180	50	60		0-4-24-192-384 / 4

NEW

Soporte Snacks Cristal rectangular
Glass Oblong Snack Stand
Support En-Cas En Verre Rectangulaire
Supporto Snacks In Vetro rettangolare
Snack-Theke Glas Rechteckig



REF.	SIZE	L(mm)	W(mm)	H(mm)	€	UE / MOQ
11800	BAJO	210	60	28		0-4-36-0-0 / 4
11801	ALTO	210	90	45		0-4-36-0-0 / 4

NEW

Plato Tiro Cristal Redondo
Glass Plate Round
Assiette Resto En Verre Ronde
Piatto Tiro In Vetro Rotondo
Runder Glasteller Tiro



REF.	SIZE	Ø(mm)	H(mm)	€	UE / MOQ
11802	S	140	13		0-4-96-0-0 / 4
11803	M	180	13		0-4-40-0-0 / 4
11804	L	220	13		0-4-40-0-0 / 4

NEW

Soporte Cristal Redondo 3 Patas
Glass Stand Round 3 Feet
Support En Verre Rond 3 Pieds
Supporto In Vetro Rdo 3 Gambe
Runder Glasaufsteller Mit 3 Füßen



REF.	Ø(mm)	H(mm)	€	UE / MOQ
11805	140	13		0-4-96-0-0 / 4

NEW

Teja Cristal Ambar
Patterned Glass Amber Roof Tile
Assiette Tuile En Verre Ambre
Tegola Di Vetro Ambar
Glasziegel Bernstein



REF.	L(mm)	W(mm)	€	UE / MOQ
11943	300	90		0-4-48-0-0 / 4

NEW

Zigzac 2 Tacos
Zigzag 2 Tacos
Zigzag 2 Tacos
Zigzag 2 Tacos
Zigzag 2 Tacos



REF.	L(mm)	W(mm)	H(mm)	€	UE / MOQ
11806	140	130	16		0-4-48-0-0 / 4

NEW

Zigzac 4 Tacos
Zigzag 4 Tacos
Zigzag 4 Tacos
Zigzag 4 Tacos
Zigzag 4 Tacos



REF.	L(mm)	W(mm)	H(mm)	€	UE / MOQ
11807	140	250	18		0-4-32-0-0 / 4

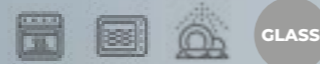

Bauhaus



Bauhaus
Presentación / Presentation



Set de maderas de presentación, concebidas tanto para un uso doméstico como para la cocina de autor, ya que las medidas están adaptadas a las últimas pautas de Gastronorm.

Con una estética atrayente por su simplicidad, Bauhaus es una propuesta versátil que enriquece rituales alrededor de una mesa como un aperitivo, momento de los postres o simplemente un brunch en casa con amigos.

La madera es un material natural que aporta un toque de calidez y sofisticación a cualquier mesa.



A set of presentation boards, conceived from a domestic use to the signature cuisine, as the measurements are adapted to the latest Gastronorm guidelines.

With an appealing aesthetic for its simplicity, Bauhaus is a versatile proposal that enriches rituals around the table such as an aperitif, the dessert moment or simply a brunch at home with friends.

Wood is a natural material that adds a touch of warmth and sophistication to any table.





Las tablas vienen preparadas con una muesca para encajar y atornillar los aros.

The tables come prepared with a notch to fit and screw the rings.



Tabla presentación

Wooden table for table service
Table en bois pour service de table
Tavolo in legno per servizio a tavola
Holztisch für tischservice

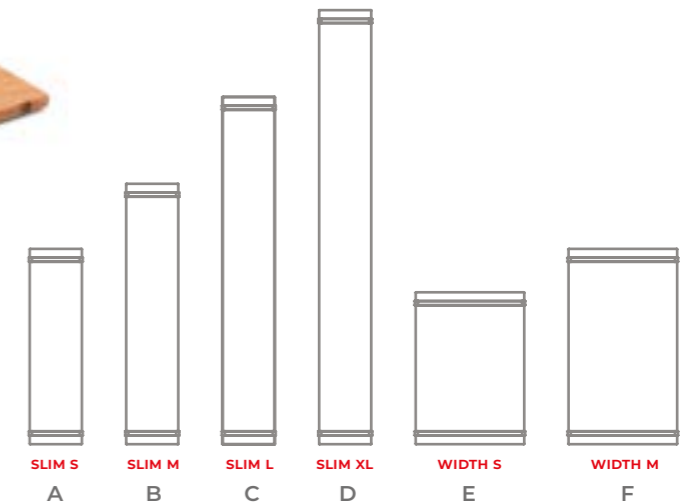

REF.	MODELO	L(mm)	W(mm)	H(mm)	AROS COMPATIBLES / COMPATIBLE RINGS	€	UE / MOQ
A 9985	SLIM S	120	450	15	10648, 10649		1-0-24 / 1
B 9986	SLIM M	120	600	15	10648, 10649		1-0-20 / 1
C 9987	SLIM L	120	800	15	10648, 10649		1-0-12 / 1
D 9988	SLIM XL	120	1000	15	10648, 10649		1-0-10 / 1
E 9989	WIDTH S	250	350	15	10719, 10720		1-0-16 / 1
F 9990	WIDTH M	250	450	15	10719, 10720		1-0-12 / 1



Pack 2 Aros

Pack 2 st/st ring
Pack 2 anneau en acier
Pack 2 anello in acciaio
Pack 2 stahling

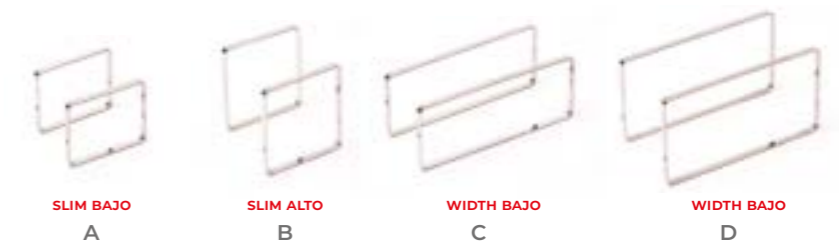

REF.	L(mm)	H(mm)	COMPATIBLE CON TABLA / COMPATIBLE WITH TABLE	€	UE / MOQ
A 10648	120	90	SLIM		1-15-60 / 2
B 10649	120	120	SLIM		1-15-60 / 2
C 10719	250	90	WIDTH		1-15-60 / 2
D 10720	250	120	WIDTH		1-15-60 / 2



Sistema modular a 2 alturas. Madera y aros se venden por separado.

Modular system at 2 heights. Wood and rings are sold by separately.

Aro de acero inoxidable.

Stainless steel ring.

INOX
STAINLESS
STEEL
201



Tablas de madera de roble.

Oak wood presentation table.

Escoge la medida de la tabla de madera y la altura de los aros para personalizar tu tabla de presentación.

Choose the size of the wooden board and the height of the hoops to customize your presentation board.



ESCOGE TU KIT / CHOOSE YOUR KIT



REF. KIT	REF. TABLA +	REF. ARO	= DESCRIPCIÓN	€	UE/MOQ
11170	9985	10648	TABLA SLIM S + ARO SLIM BAJO		1-0-0-0-0/1
11171	9985	10649	TABLA SLIM S + ARO SLIM ALTO		1-0-0-0-0/1
11172	9986	10648	TABLA SLIM M + ARO SLIM BAJO		1-0-0-0-0/1
11173	9986	10649	TABLA SLIM M + ARO SLIM ALTO		1-0-0-0-0/1
11174	9987	10648	TABLA SLIM L + ARO SLIM BAJO		1-0-0-0-0/1
11175	9987	10649	TABLA SLIM L + ARO SLIM ALTO		1-0-0-0-0/1
11176	9988	10648	TABLA SLIM XL + ARO SLIM BAJO		1-0-0-0-0/1
11177	9988	10649	TABLA SLIM XL + ARO SLIM ALTO		1-0-0-0-0/1
11178	9989	10719	TABLA WIDTH S + ARO WIDTH BAJO		1-0-0-0-0/1
11179	9989	10720	TABLA WIDTH S + ARO WIDTH ALTO		1-0-0-0-0/1
11180	9990	10719	TABLA WIDTH M + ARO WIDTH BAJO		1-0-0-0-0/1
11181	9990	10720	TABLA WIDTH M + ARO WIDTH ALTO		1-0-0-0-0/1



Tabla madera
Wooden table
Table en bois
Tavolo in legno
Eichenholztisch



REF.	L(mm)	W(mm)	H(mm)	€	UE / MOQ
11016	330	230	20		1-0-4-0-0 / 4
11017	390	280	20		1-0-4-0-0 / 4

* En caso de poner comida directamente en la bandeja, recomendamos el uso de papel anti-grasa.

If food is placed directly on the tray, we recommend the use of greaseproof paper.



Bandeja madera bambú
Bamboo tray
Plateau en bambou
Vassoio in bambù
Bambus-tablett



REF.	L(mm)	W(mm)	H(mm)	€	UE / MOQ
10998	200	100	30		1-0-4-0-0 / 4
10999	300	200	30		1-0-4-0-0 / 4
11000	400	300	30		1-0-4-0-0 / 4
11001	530	320	45		1-0-4-0-0 / 4



Pizarra + Base acacia
Slate board +Acacia base
Ardoise + Socle acacia
Ardesia + Base in acacia
Schiefer + Basis aus akazie

* Acabado brillo / Gloss finish

REF.	L(mm)	W(mm)	H(mm)	€	UE / MOQ
11574	550	345	20		1-0-0-0-0 / 1
11575	340	285	15		1-0-0-0-0 / 1
11576	340	195	15		1-0-0-0-0 / 1
11577	320	320	15		1-0-0-0-0 / 1



Pizarra
Slate board
Ardoise
Ardesia
Schiefer



REF.	FORMATO	L(mm)	W(mm)	H(mm)	€	UE / MOQ	COMPATIBLE CON / COMPATIBLE WITH:
11002	1/1	530	325	5		1-0-6-0-0 / 4	11005, 11006, 11007, 11573
11003	1/2	325	265	5		1-0-10-0-0 / 4	
11004	1/3	325	175	5		1-0-15-0-0 / 4	
11572		300	300	5		1-0-0-0-0 / 1	

Base madera para pizarra
Base for slate tray
Socle pour plateau ardoise
Base per vassoio in ardesia
Basis für schieferfach



REF.	L(mm)	W(mm)	H(mm)	€	UE / MOQ	COMPATIBLE CON / COMPATIBLE WITH:
11005	550	345	20		1-0-10-0-0 / 4	11002, 11003, 11004, 11572
11006	345	285	15		1-0-20-0-0 / 4	
11007	345	195	15		1-0-40-0-0 / 4	
11573	320	320	15		1-0-0-0-0 / 1	



Capa interior acero inoxidable.
Total seguridad para el contacto alimentario.

Stainless steel interior.
Food contact total security.

Asas de bronce.

Brass handles.



CONDUCTIVIDAD TÉRMICA

Capa exterior cobre.
Facilita la cocción gracias a que este material ayuda a crear una distribución uniforme del calor por toda la superficie.

Copper exterior.
Facilitates the cooking because this material helps to create a uniform distribution of heat on all the surface.

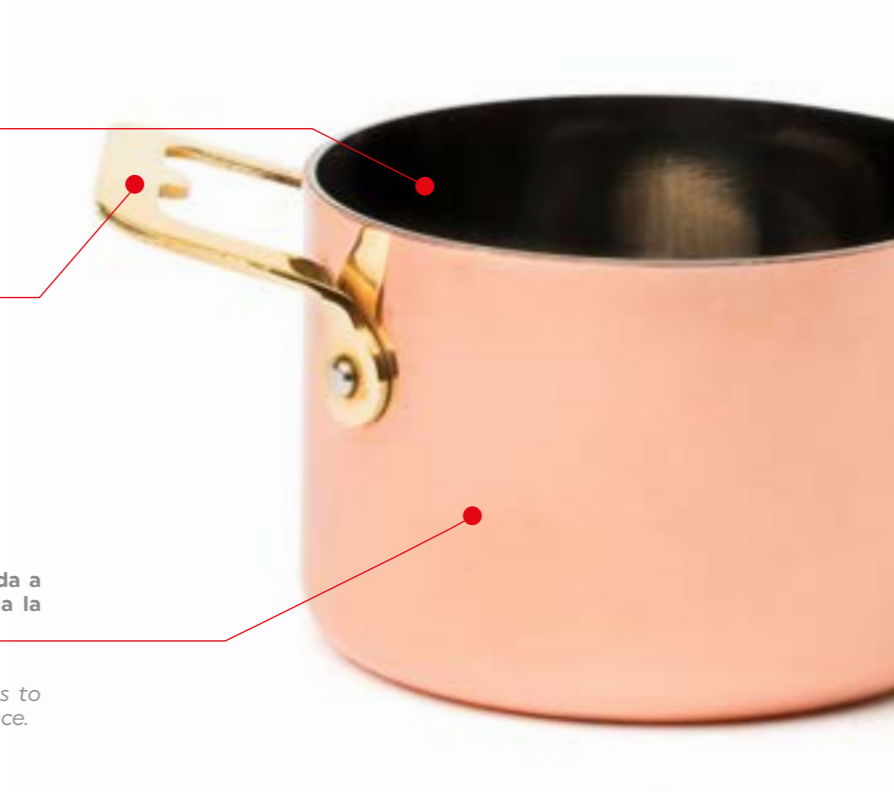

Mini sartén doble pared

Mini fry pan dual body
Mini poêle double paroi
Mini padella doppia parete
Copper mini pffanne dualer körper



REF.	Ø(mm)	H(mm)	€	UE / MOQ
7493	120	35		1-6-48-192-384 / 1

Mini olla doble pared

Mini casserole dual body
Mini casserole double paroi
Mini pentola doppia parete
Mini kasserole dualer körper



REF.	Ø(mm)	H(mm)	€	UE / MOQ
7495	90	60		1-6-48-192-384 / 1

Mini cazo doble pared

Mini saucepan dual body
Mini casserole double paroi
Mini casseruola doppia parete
Mini sauteuse dualer körper



REF.	Ø(mm)	H(mm)	€	UE / MOQ
7491	70	50		1-6-48-288-864 / 1

Mini paella doble pared

Mini paella dual body
Mini paella double paroi
Mini paella doppia parete
Mini paella pffanne dualer körper



REF.	Ø(mm)	H(mm)	€	UE / MOQ
7497	120	25		1-6-48-288-576 / 1



Mini sartén inox

Mini fry pan inox
Mini poêle inox
Mini padella inox
Mini pffanne edelstah



REF.	Ø(mm)	H(mm)	€	UE / MOQ
7492	100	30		1-6-48-192-384 / 1

Mini olla inox

Mini casserole inox
Mini casserole inox
Mini pentola inox
Mini kasserole edelstahl



REF.	Ø(mm)	H(mm)	€	UE / MOQ
7494	90	60		1-6-48-192-384 / 1

Mini cazo inox

Mini saucepan inox
Mini casserole inox
Mini casseruola inox
Mini sauteuse edelstahl



REF.	Ø(mm)	H(mm)	€	UE / MOQ
7490	70	50		1-6-48-288-864 / 1

Mini wok inox

Mini wok inox
Mini wok inox
Mini wok inox
Mini wok edelstahl



REF.	Ø(mm)	H(mm)	€	UE / MOQ
7496	110	50		1-6-48-192-384 / 1





Cubo snack
Snack bucket
Bol à aperitif
Vaschetta snack
Snack eimer



REF.	Ø(mm)	H(mm)	ml	€	UE / MOQ
7104	125	130	800		1-6-24-72-144 / 6
7103	85	90	320		1-6-24-192-576 / 6
7102	70	75	200		1-6-24-288-864 / 6

Mini cubo inox
Inox mini bin
Mini seau inox
Mini bidone inox
Mini behälter edelstahl



REF.	Ø(mm)	H(mm)	ml	€	UE / MOQ
7500	150	140	1500		1-6-48-144-432 / 6
7499	130	120	850		1-6-48-192-768 / 6
7498	90	90	350		1-6-48-576-1152 / 6

Lechera snack
Snack milk pot
Pot à lait snack
Latteria snack
Snack molkerei



REF.	Ø(mm)	H(mm)	ml	€	UE / MOQ
7105	45	50	45		1-6-24-384-1536 / 6
7106	75	100	80		1-6-24-192-384 / 6

Rustidera snack
Snack lasagna pan
Plat à rôtir snack
Rostiera snack
Snack lasagneform



REF.	Ø(mm)	H(mm)	ml	€	UE / MOQ
7107	95	145	400		1-6-24-168-336 / 6

INOX
STAINLESS
STEEL
430

Cesto cuadrado
Square basket
Panier à frites carré
Cestino quadrato da frittura
Quadratischer korb

REF.	COLOR	W _(mm)	L _(mm)	H _(mm)	€	UE / MOQ
7482	SILVER	100	90	70		1-12-144-576-576 / 6
7483	GOLD	100	90	70		1-12-144-576-576 / 6
7484	BLACK	100	90	70		1-12-144-576-576 / 6



Cesto cuadrado
Square basket
Panier à frites carré
Cestino quadrato da frittura
Quadratischer korb

REF.	W _(mm)	L _(mm)	H _(mm)	€	UE / MOQ
7485	130	110	90		1-12-144-576-576 / 6



Mini freidora cuadrada
Mini square fryer
Mini friteuse
Mini friggitore
Quadratischer mini fittierkorb

REF.	W _(mm)	L _(mm)	H _(mm)	€	UE / MOQ
7488	110	110	50		1-12-48-192-384 / 6



Cesto redondo
Round basket
Panier à frites rond
Cestino rotondo da frittura
Runder korb

REF.	Ø _(mm)	H _(mm)	€	UE / MOQ
7480	80	85		1-12-144-576-576 / 6
7481	90	125		1-12-144-576-576 / 6



Cono chips
Cone for chips
Cornet de frites
Cono per patatine fritte
Kegel für pommes

REF.	Ø _(mm)	H _(mm)	€	UE / MOQ
7487	110	230		1-12-144-576-576 / 6



Cesto rectangular
Rectangular basket
Panier à frites rectangulaire
Cestino rettangolare per frittura
Rechteckiger korb

REF.	W _(mm)	L _(mm)	H _(mm)	€	UE / MOQ
7486	210	100	40		1-6-72-288-288 / 6



Cesto con asas
Basket with handles
Panier à frites avec des poignées
Cestino da frittura maniglie
Korb mit griffen

REF.	W _(mm)	L _(mm)	H _(mm)	€	UE / MOQ
7489	110	85	55		1-12-72-720-1440 / 6

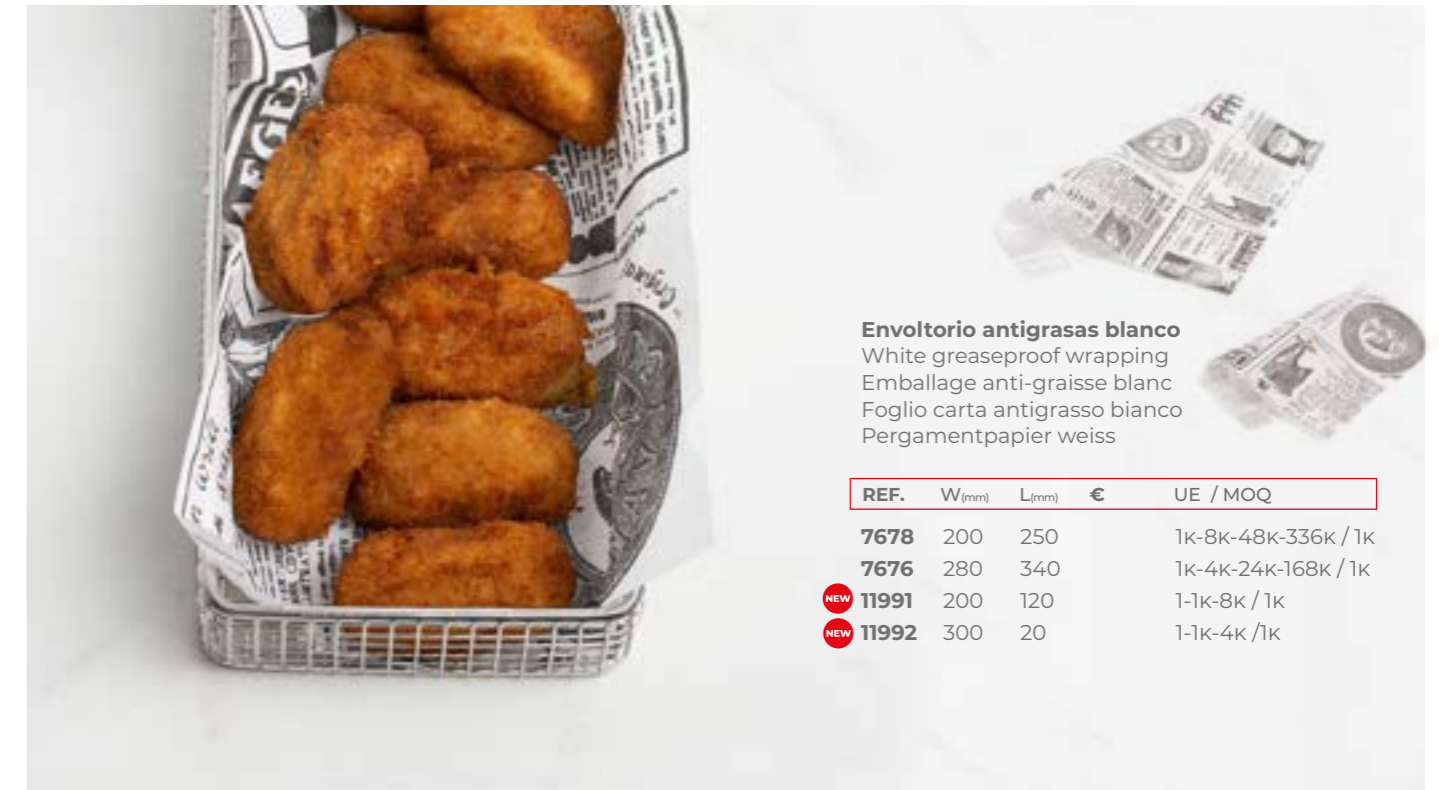

Envoltorio antigrasas blanco
White greaseproof wrapping
Emballage anti-graisse blanc
Foglio carta antigrasso bianco
Pergamentpapier weiss

REF.	W _(mm)	L _(mm)	€	UE / MOQ
7678	200	250		1k-8k-48k-336k / 1k
7676	280	340		1k-4k-24k-168k / 1k
NEW 11991	200	120		1-1k-8k / 1k
NEW 11992	300	20		1-1k-4k / 1k

Envoltorio antigrasas natural
Natural greaseproof wrapping
Emballage anti-graisse naturel
Foglio carta antigrasso naturale
Pergamentpapier natur

REF.	W _(mm)	L _(mm)	€	UE / MOQ
7677	280	340		1k-4k-24k-168k / 1k



Envoltorio antigrasas negro
Black greaseproof wrapping
Emballage anti-graisse noir
Foglio carta antigrasso nero
Pergamentpapier schwarz

REF.	W _(mm)	L _(mm)	€	UE / MOQ
7674	280	340		1k-4k-24k-168k / 1k



Envoltorio antigrasas times natural
Times natural greaseproof wrapping
Emballage anti-graisse times naturel
Foglio carta antigrasso times naturale
Pergamentpapier weiss times naturel

REF.	W _(mm)	L _(mm)	€	UE / MOQ
8809	280	340		1k-4k-24k-168k / 1k



Envoltorio antigrasas rojo
Red greaseproof wrapping
Emballage anti-graisse rouge
Foglio carta antigrasso rosso
Pergamentpapier rot

REF.	W _(mm)	L _(mm)	€	UE / MOQ
7675	280	340		1k-4k-24k-168k / 1k



Sala / Dining room
TRADICIÓN COLLECTION



Mini caldero 3 patas
Mini cooking pot 3 feet
Mini cocotte en fonte 3 pieds
Mini casseruola di ghisa 3 piedi
Gusseisen mini kasserole m. 3 füßen

COMPATIBLE CON:

7789



REF.	Ø(mm)	H(mm)	ml	€	UE / MOQ
7510	110	95	35		1-6-12-96-288 / 1



Mini sartén cuadrada
Mini square pan
Mini poêle carrée en fonte
Mini padella quadrata di ghisa
Gusseisen quadratische mini pfanne

COMPATIBLE CON:

7791



REF.	W(mm)	L(mm)	H(mm)	€	UE / MOQ
7503	140	140	30		1-6-12-96-384 / 1



Mini olla oval
Mini oval casserole
Mini cocotte ovale en fonte
Mini casseruola ovale di ghisa
Gusseisen ovale mini kasserole

COMPATIBLE CON:

7790



REF.	W(mm)	L(mm)	H(mm)	ml	€	UE / MOQ
7506	95	125	55	270		1-6-12-48-144 / 1



Mini sartén redonda 2 asas
Mini round pan 2 handles
Mini poêle ronde en fonte 2 poignets
Mini padella rotonda di ghisa 2 manici
Gusseisen runde mini pfanne m. 2 griffen

COMPATIBLE CON:

7789



REF.	Ø(mm)	H(mm)	€	UE / MOQ
7508	122	30		1-6-24-144-576 / 1

Hierro fundido / Cast Iron



Mini sartén
Mini pan
Mini poêle en fonte
Mini padella di ghisa
Gusseisen mini pfanne

COMPATIBLE CON:

7789



REF.	Ø(mm)	H(mm)	€	UE / MOQ
7502	90	25		1-6-24-192-768 / 1



Mini sartén
Mini pan
Mini poêle en fonte
Mini padella di ghisa
Gusseisen mini pfanne

COMPATIBLE CON:

7789



REF.	Ø(mm)	H(mm)	€	UE / MOQ
7501	130	15		1-6-24-192-768 / 1



Mini sartén oval 2 asas
Mini oval pan 2 handles
Mini poêle ovale en fonte 2 poignets
Mini padella ovale di ghisa 2 manici
Gusseisen ovale mini pfanne m. 2 griffen

COMPATIBLE CON:

7790



REF.	W(mm)	L(mm)	H(mm)	€	UE / MOQ
7507	180	126	35		1-6-24-96-288 / 1



Mini sartén redonda 2 asas
Mini round pan 2 handle
Mini poêle ronde en fonte 2 poignets
Mini padella rotonda di ghisa 2 manici
Gusseisen runde mini pfanne m. 2 griffen

COMPATIBLE CON:

7789



REF.	Ø(mm)	H(mm)	€	UE / MOQ
7509	145	30		1-6-24-144-576 / 1

Bases de madera / Wooden board



1 Lavar antes del primer uso.
Wash before first use.



2 Después de cada uso, dejar enfriar y lavar a mano.
After each use, leave to cool and wash by hand.



3 Untar con aceite para una mejor conservación.
Spread with oil for better preservation.

* **Nuestras piezas de hierro fundido no son antideslizantes.**
Our cast iron griddles are not non-stick items.



Mini olla
Mini casserole
Mini cocotte en fonte
Mini casseruola di ghisa
Gusseisen mini kasserole

COMPATIBLE CON:

7789



REF.	Ø(mm)	H(mm)	ml	€	UE / MOQ
7504	140	110	60		1-6-12-48-144 / 1



Mini olla
Mini casserole
Mini cocotte en fonte
Mini casseruola di ghisa
Gusseisen mini kasserole

COMPATIBLE CON:

7789



REF.	Ø(mm)	H(mm)	ml	€	UE / MOQ
7505	110	60	35		1-6-24-96-288 / 1



Soporte madera
Wooden board
Support en bois
Table di legno
Holzplatte



ROUND



OVAL



SQUARE

REF.	MODEL	W(mm)	L(mm)	€	UE / MOQ
7789	ROUND	150	150		1-6-12-168-504 / 1
7790	OVAL	200	140		1-6-12-144-432 / 1
7791	SQUARE	160	160		1-6-12-144-432 / 1





Hierro esmaltado / Enamelled Iron



Servicio mesa / Miniaturas
 Table top / Miniatures



Cuenco rectangular
 Rectangular pie dish
 Bol rectangulaire
 Ciotola rettangolare
 Eisenschälchen rechteckig

REF.	W _(mm)	L _(mm)	H _(mm)	€	UE / MOQ
7517	145	200	40		1-12-48-480-1600 / 12
7516	130	180	35		1-12-96-768-2304 / 12
7515	120	160	30		1-12-96-864-2592 / 12

Cuenco rectangular
 Rectangular pie dish
 Bol rectangulaire
 Ciotola rettangolare
 Eisenschälchen rechteckig

REF.	W _(mm)	L _(mm)	H _(mm)	€	UE / MOQ
7520	145	200	40		1-12-48-432-1296 / 12
7519	130	180	35		1-12-96-768-2304 / 12
7518	120	160	30		1-12-96-864-2592 / 12



Plato llano
 Flat plate
 Assiette plate
 Piatto piano
 Flacher teller

Plato hondo
 Deep plate
 Plat creux
 Piatto fondo
 Tiefer teller

Plato postre
 Dessert plate
 Assiette dessert
 Piatto dessert
 Dessertteller

REF.	SIZE	Ø _(mm)	H _(mm)	€	UE / MOQ
10909	PLATO LLANO	260	20		0-12-48-0-0 / 12
10910	PLATO HONDO	220	35		0-12-48-0-0 / 12
10908	PLATO POSTRE	200	15		0-12-96-0-0 / 12

Sala / Dining room
PELTRE COLLECTION



Cuchara de té
Tea spoon
Cuillère à thé
Cucchiaio da tè
Teelöffel

Cuchara de mesa
Table spoon
Cuillère de table
Cucchiaio da tavola
Tafelöffel

Cuchara de servir
Server spoon
Cuillère servir
Cucchiaio da portata
Servierlöffel

REF.	SIZE	L(mm)	€	UE / MOQ
7511	CUCHARA DE TÉ	150		1-12-120-3000-6000 / 12
7512	CUCHARA DE MESA	200		1-12-120-3000-6000 / 12
7513	CUCHARA DE SERVIR	300		1-10-50-1600-3200 / 10

Vaso para dippear
Dip cup
Mini coupe pour tremper
Bicchiere per sugo
Eisen dipschale



REF.	Ø(mm)	H(mm)	ml	€	UE / MOQ
7530	70	30	100		1-12-96-1152-2304 / 12
7529	60	40	90		1-12-96-1920-3840 / 12

Lechera
Creamer
Laitière
Bidone del latte
Eisenkännchen



REF.	Ø(mm)	H(mm)	ml	€	UE / MOQ
7514	70	65	190		1-12-96-384-768 / 12

Vaso alto
Taller tumbler
Coupe hauteur
Bicchiere
Emailliertes



REF.	Ø(mm)	H(mm)	ml	€	UE / MOQ
7528	80	120	400		1-12-48-192-384 / 12
7527	80	90	290		1-12-96-384-768 / 12

Taza
Mug
Tasse
Tazza
Eisenbecher



REF.	Ø(mm)	H(mm)	ml	€	UE / MOQ
7522	70	70	250		1-12-96-384-1152 / 12
7521	60	45	100		1-12-96-384-1152 / 12

Cazuela 2 asas
Casserole 2 handle
Casserole 2 poignées
Casseruola 2 manici
Kasserole mit griff



REF.	Ø(mm)	H(mm)	ml	€	UE / MOQ
7525	100	50	310		1-12-96-384-768 / 12

Bol
Bowl
Bol
Ciotola
Eisenschale



REF.	Ø(mm)	H(mm)	ml	€	UE / MOQ
7526	140	60	510		1-12-48-576-1152 / 12

Hierro esmaltado / Enamelled iron



Servicio mesa / Miniaturas
Table top / Miniatures



Fuente acero esmaltada con asas
Deep enamelled fry pan with handles
Poêle haute avec anses
Padella smaltata con manici
Emaillierte platte mit griffen

REF.	Ø(mm)	€	UE / MOQ
10934	120		1-6-48 / 6
10935	160		1-6-48 / 6
10936	200		1-6-48 / 6

Sartén honda
Deep frying pan
Poêle profonde
Padella
Mini-pfannen



REF.	Ø(mm)	H(mm)	€	UE / MOQ
7826	140	38		1-10-60-360-1020 / 10
7827	160	43		1-10-50-200-1000 / 10
7828	180	48		1-6-36-1008-1008 / 6
7829	200	53		1-6-42-924-924 / 6

Paellera
Paella pan
Poêle à paella
Padella
Paella-pfannen



REF.	Ø(mm)	H(mm)	€	UE / MOQ
7792	100	20		1-10-100-300-1000 / 10
7793	120	22		1-10-100-400-1000 / 10
7794	150	24		1-10-80-320-960 / 10
7795	200	26		1-6-36-648-648 / 6

Cazuela 2 asas marrón
Brown casserole 2 handle
Casserole émaillé 2 poignées brown
Casseruola ferro smaltato 2 manici brown
Emaillierte kasserole mit griff brown



REF.	Ø(mm)	H(mm)	ml	€	UE / MOQ
7524	100	50	310		1-12-96-384-768 / 6

Mini cazuela 2 asas marrón
Brown mini casserole 2 handle
Mini casserole émaillé 2 poignées brown
Mini casseruola ferro smaltato 2 manici brown
Emaillierte mini kasserole mit griff brown



REF.	Ø(mm)	H(mm)	ml	€	UE / MOQ
7523	100	30	125		1-12-48-576-1728 / 6



Madera de haya de alta calidad.

High quality beech wood.

Acabados con aceites naturales que protegen y alargan la durabilidad de las piezas.

Finishes with natural oils that protect and prolong the pieces durability.



Mini palé
 Mini pallet
 Mini palette
 Mini bancale
 Mini palette



REF.	L _(mm)	W _(mm)	H _(mm)	€	UE / MOQ
7548	200	120	35		0-3-36-288-864 / 3
NEW 11965	180	300	35		1-0-20-0-0 / 1



Mini caja cuadrada
 Mini square box
 Mini cagette carrée en bois
 Mini cassetta legno quadrata
 Quadratische mini holzbox

REF.	L _(mm)	W _(mm)	H _(mm)	€	UE / MOQ
7544	170	170	70		1-0-12-48-144 / 6
7545	210	210	70		1-0-12-72-216 / 6



Mini caja rectangular
 Mini rectangular wooden box
 Mini cagette rectangulaire
 Mini cassetta legno rettangolare
 Rechteckige mini holzbox

REF.	L _(mm)	W _(mm)	H _(mm)	€	UE / MOQ
7542	150	100	50		1-0-32-128-384 / 6
7543	230	130	70		1-0-12-48-144 / 6
7546	240	160	70		1-0-12-48-144 / 6



Mini caja
 Mini wooden box
 Mini cagette en bois
 Mini cassetta legno
 Mini holzbox

REF.	L _(mm)	W _(mm)	H _(mm)	€	UE / MOQ
7539	125	80	90		1-0-24-192-384 / 6
7540	130	170	90		1-0-12-36-288 / 6



DIM-SUM

Vaporera bambú
Bamboo Steamer
Vapocuseur Bambou
Vaporiera Bamboo
Bambusdämpfer



REF.	Ø(mm)	H(mm)	PISOS	RACIONES	€	UE / MOQ
7830	100	70	1	TAPA		1-4-36 / 4
7831	130	85	1	RACIÓN		1-4-36 / 4
7832	150	85	1	INDIVIDUAL		1-4-72 / 4
11966	200	135	2	2 RACIONES		1-0-8 / 1
11967	250	160	2	3-4 RACIONES		1-0-6 / 1
11968	300	165	2	5-6 RACIONES		1-0-3 / 1

NEW

Papel Perforado Vaporera Bamboo

Perforated Bamboo Steamer Paper
Papier Perforé Vapocuseur Bambou
Foglio Di Carta In Bambu' Perforato Per Vaporiera
Perforiertes Papier Für Bambusdämpfer



REF.	Ø(mm)	€	UE / MOQ
11969	130		1-250-2000/ 250
11970	170		1-250-2000/ 250
11971	280		1-250-2000/ 250



Mango hueco para una manipulación más ligera.
Hollow handle for lighter handling.



- A **7421** SET PALILLOS INOX
chopsticks set 18/10, set baguettes 18/10, set bacchettes 18/10, esstübchen set 18/10
- B **7422** SET PALILLOS BLACK
chopsticks set black 18/10, set baguettes black 18/10, set bacchettes black 18/10, esstübchen set 18/10 black
- C **7423** SET PALILLOS COPPER
chopsticks set copper 18/10, set baguettes copper 18/10, set bacchettes copper 18/10, esstübchen set 18/10 copper
- D **7424** SET PALILLOS GOLD
chopsticks set gold 18/10, set baguettes gold 18/10, set bacchettes gold 18/10, esstübchen set 18/10 gold
- E **7554** REPOSA PALILLOS BLOQUE SATIN
chopsticks rest satin 18/10, porte baguette satin 18/10, supporto posate satin 18/10, besteckhalter satin 18/10
- F **7555** REPOSA PALILLOS BLOQUE NEGRO
chopsticks rest black 18/10, porte baguette black 18/10, supporto posate black 18/10, besteckhalter black 18/10

€	UE	MOQ	✂ mm	✂ mm
	0/12/120/1920/5760	12	230	11
	0/12/120/1920/5760	12	230	11
	0/12/120/1920/5760	12	230	11
	0/12/120/1920/5760	12	230	11
	0/12/120/1920/5760	12	60	11
	0/12/120/1920/5760	12	60	

Sakura



FIBRE GLASS

- 6935** SET PALILLOS
chopsticks set 18/10, set piques 18/10, set bacchettes 18/10, estübchen-set 18/10
- 7869** SOPORTE CUBIERTOS
cutlery holder, panier à pouverts, supporto coperte, besteckhalter

€	UE	MOQ	✂ mm	✂ mm
	0/6/60/1440/4320	60	228	
	0/6/60/1440/4320	60	206	



Fondo sellado con silicona que permite contener líquido con total seguridad.

Silicone sealed bottom allows contain liquids safely.

ZINC

Cubo galvanizado
Zinc ice bucket
Seau en acier galvanisé
Cubetto galvanizzato
Zinn-eiskühler

REF.	SIZE	W(mm)	L(mm)	H(mm)	ml	€	UE / MOQ
7533	XL	350	510	230	24000		1-6-48-192-384 / 1
7534	M	300	390	187	14000		1-8-64-256-512 / 1

INOX STAINLESS STEEL 201 COTTON

Enfriador de botella inox
Bottle cooler inox
Glacette inox
Refrigeratore inox
Edelstahlkühle



REF.	COLOR	Ø(mm)	H(mm)	ml	€	UE / MOQ
2765	INOX	120	180	1.250		1-0-6-54-162 / 6
2787	BEIGE	120	180	1.250		1-0-6-54-162 / 6
2788	BROWN	120	180	1.250		1-0-6-54-162 / 6
2789	GREEN	120	180	1.250		1-0-6-54-162 / 6

INOX STAINLESS STEEL 201

Pie cubo champagnera 2 botellas
Champagne bucket stand 2 bottles
Pied porte-seau champagne 2 bouteilles
Colona portasecchiolo 2b
Ständer f. 2 champagnerkühler

REF.	Ø(mm)	H(mm)	€	UE / MOQ
5653	220	630		1-0-4-32-64 / 1

COMPATIBLE CON: 4967 - 5513 - 3095 (p.413)

INOX STAINLESS STEEL 201

Pie cubo champagnera 1 botella
Champagne bucket stand 1 bottle
Pied porte-seau champagne 1 b.
Colona portasecchiolo 1b.
Ständer f. 1 champagnerkühler

REF.	H(mm)	€	UE / MOQ
2786	720		1-0-1-16-80 / 1

COMPATIBLE CON: 4967 - 3095 (p.413)

INOX STAINLESS STEEL 201

Soporte cubo mesa
Wine bucket stand support
Support de table pour seau
Supporto secchio tavola
Halter für tischeimer

REF.	Ø(mm)	€	UE / MOQ
7112	200		1-0-5-30-60 / 5



COMPATIBLE CON:
4967 (p.413)



INOX
STAINLESS
STEEL
201

Cubitera tipo ensaladera
Ice cube bowl
Vasque
Coppa con base
Champagner kühler becken



REF.	Ø(mm)	H(mm)	ml	€	UE / MOQ
2727	345	230	10.000		1-0-1-12-12 / 1

Cubo champagne 2 bot.
2 bottles champagne bucket
Seau champagne 2 bouteilles
Rinfrescatore champane 2b
Champagner kühler



REF.	Ø(mm)	H(mm)	ml	€	UE / MOQ
5513	240	215	6.500		1-0-4-24-48 / 1

Cubo hielo inox
Stainless steel ice bucket
Seau à glace inox
Secchiello ghiaccio
Edelstahl eiseimer



REF.	Ø(mm)	H(mm)	ml	€	UE / MOQ
3093	110	130	800		1-0-20-80-160 / 1

Champagnera inox
Stainless steel champagne bucket
Seau à champagne
Secchiello champagne
Champagne eimer



REF.	Ø(mm)	H(mm)	ml	€	UE / MOQ
3095	190	190	3.500		1-0-6-18-54 / 6

Cubo hielo Lux
Bucket lux
Seau à glace lux
Secchiello ghiaccio lux
Eiseimer lux



REF.	Ø(mm)	H(mm)	ml	€	UE / MOQ
3096	120	125	1.000		1-0-20-80-60 / 1

Cubo champagne
Champagne bucket
Seau champagne
Rinfrescatore champane
Champagner kühler



REF.	Ø(mm)	H(mm)	ml	€	UE / MOQ
4967	200	210	3.500		1-0-6-42-126 / 6

Cubo hielo isotérmico
Double wall plain
Seau à glace isotherme
Secchiello ghiaccio isolato
Isoliert eiseimer



REF.	Ø(mm)	H(mm)	ml	€	UE / MOQ
3097	120	135	1.000		1-0-20-60-120 / 1

Cubo hielo
Ice bucket
Seau à glaçons
Secchiello ghiaccio
Eisbehälter



REF.	Ø(mm)	H(mm)	ml	€	UE / MOQ
4968	140	130	1.000		1-0-20-160-320 / 10



Servicio mesa / Paneras
Table top / Breadbaskets



Panera redonda kraft lavable 17
Washable round kraft breadbasket 17
Corbeille à pain ronde kraft lavable 17
Portopane rotondo kraft lavabile 17
Baschbarkraft, runder brotkorb 17

REF.	Ø(mm)	H(mm)	€	UE / MOQ
7455	170	120		1-5-50-200-400 / 5



Panera oval kraft lavable
Washable oval kraft breadbasket
Corbeille à pain ovale kraft lavable
Portopane ovale kraft lavabile
Baschbarkraft, ovaler brotkorb

REF.	W(mm)	L(mm)	H(mm)	€	UE / MOQ
7457	250	180	130		1-5-50-200-400 / 5

COMPATIBLE CON: **7459** (p.417)



Panera redonda kraft lavable 20
Washable round kraft breadbasket 20
Corbeille à pain ronde kraft lavable 20
Portopane rotondo kraft lavabile 20
Baschbarkraft, runder brotkorb 20

REF.	Ø(mm)	H(mm)	€	UE / MOQ
7456	200	120		1-5-50-200-400 / 5

COMPATIBLE CON: **7459** (p.399)

Material kraft.

Kraft Material



30°C

3 CAPAS LAYERS

COTTON



Panera redonda gris 17
Round grey Breadbasket 17
Corbeille à pain ronde grise 17
Portopane rotondo grigio 17
Grauer, runder brotkorb 17

REF.	Ø(mm)	H(mm)	€	UE / MOQ
7451	170	100		1-5-50-200-400 / 5



Panera redonda gris 20
Round grey Breadbasket 20
Corbeille à pain ronde grise 20
Portopane rotondo grigio 20
Grauer, runder brotkorb 20

REF.	Ø(mm)	H(mm)	€	UE / MOQ
7452	200	120		1-5-50-200-400 / 5

COMPATIBLE CON: **7459** (p.399)



Panera oval gris
Oval grey breadbasket
Cobeille à pain ovale grise
Portopane ovale grigio
Grauer, ovaler brotkorb

REF.	W(mm)	L(mm)	H(mm)	€	UE / MOQ
7453	200	150	100		1-5-50-200-400 / 5
7454	250	180	120		1-5-50-200-400 / 5

COMPATIBLE CON: **7459** (p.399)



Capas exteriores:
100% algodón
Capa interior:
35% algodón
65% poliéster

Outer layers:
100% cotton
Inner layer:
35% cotton
65% polyester

+RIGIDEZ / RIGIDITY





MANTIENE EL CALOR
KEEPS WARM

Piezas de cerámica sin esmalte que mantienen el calor durante 45 minutos con sólo 30 segundos de microondas.

Glaze-free ceramic beans keep warm for 45 minutes with only 30 seconds of microwave.

3
CAPAS
LAYERS + RIGIDEZ
RIGIDITY

Panera grissini
Breadsticks holder
Corbeille à grissini
Cestino porta grissini
Brotkorb für grissini

COTTON

REF.	COLOR	Ø(mm)	H(mm)	€	UE / MOQ
7779	GRIS	100	220		1-5-50-200-400 / 5
7778	BEIGE	100	220		1-5-50-200-400 / 5



Panera cuadrada 100% algodón
Square breadbasket 100% cotton
Corbeille à pain carrée
Portopane quadrato
Quadratischer brotkorb

COTTON

REF.	COLOR	W(mm)	L(mm)	H(mm)	€	UE / MOQ
7598	BEIGE	120	120	140		1-5-50-200-400 / 5
7599	GRIS	120	120	140		1-5-50-200-400 / 5



PACKAGING
HANG TAG



Calentador con cerámica térmica
Warmer with ceramic beans
Corbeille à pain thermique
Portopane termico
Thermo-brotkorb

COTTON

REF.	Ø(mm)	H(mm)	€	UE / MOQ
7458	200	130		1-5-50-200-400 / 5



Accesorio cerámica térmica
Ceramic beans warmer bag
Base thermique
Base termica
Thermo-basis



REF.	Ø(mm)	€	UE / MOQ
7459	190		1-5-50-200-400 / 5

COMPATIBLE CON / COMPATIBLE WITH: (p.397)



7456 7457 7452 7453 7454

INOX
STAINLESS
STEEL
201

Panera inox
Bread basket
Corbeille à pain
Porta pane
Brotkorb

REF.	Ø(mm)	H(mm)	€	UE / MOQ
4952	200	95		1-4-48-720.3600 / 5



BOROSILICATE

+ RESISTENCIA
RESISTANCE

ANTIGOTEO

Set 2 pzas. vinagrera antigoteo
Non drip 2 pieces cruet set
Ménagère, 2 pièces
Servizio oliera, 2 pezzi
Menage, 2-teilig



REF.	ml	€	UE / MOQ
8387	260		1-0-12-125-375 / 12

BOROSILICATE

+ RESISTENCIA
RESISTANCE

ANTIGOTEO

Botella antigoteo
Non drip bottle
Bouteille anti-goutte
Bottiglia antigoccia
Anti-tropf-flasche



REF.	ml	€	UE / MOQ
8388	500		1-0-24-63-189 / 24
8389	250		1-0-36-144-288 / 36

GLASS

CUADRADA

Set 2 pzas. vinagrera cuadrada
2 pieces square cruet set
Ménagère, 2 pièces
Servizio oliera, 2 pezzi
Menage, 2-teilig



REF.	ml	€	UE / MOQ
8393	250		1-0-24-125-375 / 24

GLASS

CUADRADA

Set 4 pzas. vinagrera cuadrada
4 pieces square cruet set
Ménagère, 4 pièces
Servizio oliera, 4 pezzi
Menage, 4-teilig



REF.	ml	€	UE / MOQ
8392	250		1-0-12-250-1000 / 12

Boquilla fina para verter el líquido con precisión.

Fine spout for precision pouring.

Fácil de rellenar gracias a su boquilla extraíble.

Removable spout makes for easy refilling.

Collar que recoge las gotas que puedan quedar en la boquilla y evita ensuciar la mesa.

Collar that collects any liquid left in the spout and keeps the table clean..

Cuello de vidrio glaseado que fija la boquilla.

Frosted glass collar that keeps the spout in place.

BOROSILICATE



PACKAGING BOX

GLASS

PARIS

Vinagrera PARIS 2 piezas
2 pieces cruet set PARIS
Ménagère 2 pièces PARIS
Oliera 2pc. mod. PARIS
2-Teilige menage PARIS



REF.	ml	€	UE / MOQ
3698	150		1-0-24-216-216 / 4

PARIS

Juego sal pimienta y mostaza
Salt, pepper and mustard set
Ménagère sel, poivre et moutarde
Sale pepe e senape mod.
Salz/pfeffer/senf-set



REF.	ml	€	UE / MOQ
3165	150		1-0-24-192-384 / 4

INOX

Vinagrera inox 2 piezas
2 pieces cruet set inox
Ménagère 2 pièces inox
Oliera 2pc. inox
2-Teilige menage inox



REF.	ml	€	UE / MOQ
3164	175		1-0-24-144-144 / 4

Blister 2 saleros

Blister 2 salt shakers
Blister 2 salières
Blister 2 salino
Blister 2 glas-salzstreuer



REF.	€	UE / MOQ
5160		1-0-100-400-400 / 10

PARIS

Vinagrera PARIS 4 piezas
4 pieces cruet set PARIS
Ménagère 4 pièces PARIS
Oliera 4pc. mod. PARIS
4-Teilige menage PARIS



REF.	ml	€	UE / MOQ
3697	150		1-0-24-96-192 / 4

PARIS

Juego sal y pimienta PARIS
Salt & pepper set PARIS
Ménagère sel et poivre PARIS
Sale e pepe mod. PARIS
Salz/pfeffer-set PARIS



REF.	€	UE / MOQ
3699		1-12-72-432-864 / 4

INOX

Vinagrera inox 4 piezas
4 pieces cruet set inox
Ménagère 4 pièces inox
Oliera 4 pc. inox
4-Teilige menage inox



REF.	ml	€	UE / MOQ
3103	175		1-0-24-96-96 / 4

NEW YORK

Vinagrera 4 piezas PVC
4 pieces PVC cruet set
Ménagère 4 pièces
Oliera 4pc.
4-Teilige Menage



REF.	ml	€	UE / MOQ
5159	150		1-0-24-96-96 / 4



Caja salsa
Table caddies
Cagette sauces
Cassetta per salse
Tisch organizer



REF.	W(mm)	L(mm)	H(mm)	€	UE / MOQ
7840	200	150	180		1-0-12-36-72 / 1

GLASS

CUADRADA

Botella cuadrada
Square oil bottle
Ménagère carré
Oliera quadrata
Square menage



REF.	ml	H(mm)	€	UE / MOQ
8390	250	250		1-0-36-84-168 / 36

CUADRADA

Soporte 2 pzas. vinagrera cuadrada
Stand 2 pieces square cuet set
Porte huile et vinaigre
Porta olio/acetato
Essig u. Öl-stand



REF.	H(mm)	€	UE / MOQ
8394	285		1-0-24-126-252 / 24



Bandeja ovalada
Oval heavy try
Plateau ovale
Vassoio ovale
Tablett oval

REF.	W(mm)	L(mm)	€	UE / MOQ
7093	170	250		1-0-24-336-1344 / 6
7094	210	300		1-0-24-264-1056 / 6
7095	235	350		1-0-24-192-576 / 6
7096	270	400		1-0-24-168-504 / 6
7097	295	450		1-0-24-96-384 / 6
7098	340	500		1-0-24-96-384 / 6
7099	415	600		1-0-20-40-160 / 6

Bandeja 12 rec. vinagrera PARIS
Pack 12 oil/vinegar bottle PARIS
Pack 12 bouteilles recharge PARIS
Pack 12 rec. oliera PARIS
12 teilige PARIS



REF.	ml	€	UE / MOQ
3783	150		1-0-8-40-80 / 4

Bandeja 12 saleros Paris
Salt/pepper shakers PARIS
Salières PARIS
Sale PARIS
Ersalzflaschen PARIS



REF.	H(mm)	€	UE / MOQ
3905	90		1-12-300 / 1

CUADRADA

Tapón vinagrera cuadrada
Cap square bottle
Bouchon de burette
Tappo di oliera
Menage stopper



REF.	€	UE / MOQ
8391		1-12-300 / 12



Bandeja pescado
Fish tray
Plateau poisson
Piatto pesce
Fischtablett

REF.	W(mm)	L(mm)	€	UE / MOQ
7100	250	600		1-0-20-80-400 / 6
7101	258	700		1-0-20-80-400 / 6

INOX
STAINLESS
STEEL
201



BAR COCKTAIL



406 SERVICIO MESA
/ TABLE TOP

**408 COCTELERÍA
Y ACCESORIOS**
/ COCKTAILS AND ACCESSORIES



Tratamiento antideslizante:
Textura engomada que evita que los objetos se deslicen por la superficie con el movimiento.

Anti-slip:
Rubbery surface texture that keeps pieces in place while you carry them.



Fabricada en FIBERGLASS la convierte en una bandeja muy ligera, indeformable y apta para lavavajillas.

Made in FIBERGLASS, this tray is very light, unbendable and dishwasher safe.

PP
POLYPROPYLENE



Bandeja antideslizante
Non slip serving tray
Plateau de service antidérapant
Vassoio antiscivolo
Rutschfestes serviertablett

REF.	Ø(mm)	€	UE / MOQ
8413	360		1-0-12-72-504 / 12
8414	400		1-0-12-72-216 / 12

FIBER-GLASS



Bandeja FIBERGLASS antideslizante
FB round non slip serving tray
Plateau de service rond antidérapant FB
Piatto da portata rotondo antiscivolo FB
Rutschfreies rundes FB serviertablett

REF.	Ø(mm)	€	UE / MOQ
8420	360		1-0-12-72-482 / 12
8421	400		1-0-12-72-216 / 12

FIBER-GLASS



Bandeja FIBERGLASS antideslizante rectangular
FB rectangle non slip serving tray
Plateau de service rectangle antidérapant FB
Piatto da portata rettangolare antiscivolo FB
Rutschfreies rechteck FB serviertablett

REF.	W(mm)	L(mm)	€	UE / MOQ
8415	360	460		1-0-12-48-336 / 12
8416	380	510		1-0-12-48-192 / 12
8417	400	560		1-0-12-48-192 / 12

FIBER-GLASS



Bandeja FIBERGLASS antideslizante oval
FB oval non slip serving tray
Plateau de service ovale antidérapant FB
Piatto da portata ovale antiscivolo FB
Rutschfreies oval FB serviertablett

REF.	W(mm)	L(mm)	€	UE / MOQ
8418	560	680		1-0-6-12-27 / 6

BEECH



Soporte bandeja
Tray support
Support de plateau
Supporto vassoio
Unterstützung serviertablett

REF.	W(mm)	L(mm)	H(mm)	€	UE / MOQ
8419	440	433	835		1-0-1-3-20 / 1

INOX STAINLESS STEEL 201



Bandeja camarero
Serving tray
Plateau barman
Vassoio bar
Serviertablett

REF.	Ø(mm)	€	UE / MOQ
4950	400		1-0-12-72-432 / 6

INOX
STAINLESS
STEEL
201



Coctelera delux
Cocktail shaker delux
Shaker delux
Shaker per cocktail delux
Cocktailshaker delux

REF.	H(mm)	ml	€	UE / MOQ
3024	190	750		1-0-24-192-192 / 1
3023	165	500		1-0-24-120-120 / 1



Vaso medidor
Measuring cup
Verre mesureur
Misurino cocktail
Messglas

REF.	H(mm)	ml	€	UE / MOQ
3021	100	30 / 60		1-24-96-384-1920 / 6



Cuchara coctel
Cocktail spoon
Cuillère cocktail
Cucchiaio cocktail
Cocktailöffel

REF.	L(mm)	€	UE / MOQ
3151	290		1-12-120-1080-2160 / 12

Coctelera con filtro
Cocktail shaker w / filter
Shaker avec filtre
Shaker per cocktail filtro
Cocktailshaker mit filter



REF.	H(mm)	ml	€	UE / MOQ
3022	190	500		1-0-24-120-120 / 1



Colador gusanillo
Bar strainer Mickey mouse
Passoir à cocktail mickey mouse
Colino cocktail mickey mouse
Barstrainer mickey mouse

REF.	L(mm)	€	UE / MOQ
3027	145		1-24-96-768-2304 / 6



Cuchara sangría
Sangría spoon
Cuillère sangria
Cucchiaio sangria
Sangriöffel

REF.	L(mm)	€	UE / MOQ
2728	270		1-12-120-1920-9600 / 12

INOX
STAINLESS
STEEL
430

INOX
STAINLESS
STEEL
201

Cenicero agua
Water ashtray
Cendrier eau
Portacenere
Wasser-aschenbecher



REF.	Ø(mm)	H(mm)	€	UE / MOQ
4951	95	38		1-0-96-768-768 / 6

Jarra agua
Water jug
Carafe d'eau
Caraffa d'acqua
Wasserkaraffe



REF.	Ø(mm)	H(mm)	ml	€	UE / MOQ
3030	100	145	1.250		1-0-6-48-144 / 6

Servilletero
Napkin dispenser
Distributeur serviettes
Portasalviette
Serviettenhalter



REF.	W(mm)	H(mm)	€	UE / MOQ
5039	130	100		1-0-24-144-288 / 6

Pisamanteles pack 4
Tablecloth clip
Clips nappe
Molle fermatovaglia
Teilige tischdeckenklipse



REF.	€	UE / MOQ
3456		1-0-100-1500-4500 / 25

Sacacorchos
Waiter's corkscrew
Tire-bouchon de serveur
Cavatappi cameriere
Kellnermesser



REF.	L(mm)	€	UE / MOQ
8479	120		1-12-72-720-2880 / 24

Cenicero abierto
Round ashtray
Cendrier
Portacenere
Offener aschenbecher



REF.	Ø(mm)	H(mm)	€	UE / MOQ
7113	100	35		1-0-90-720-1440 / 6

Placa reservado
Table tag reservado
Plaquette de table reservado
Targhetta tavola reservado
Tischaufsteller reservado



REF.	W(mm)	€	UE / MOQ
9709	190		1-25-100-1200-4800 / 25

Soporte copas
Glass racks
Support verres à pied
Cremagliera di vetro
Glashalter



REF.	L(mm)	€	UE / MOQ
3102	400		1-0-24-144-432 / 6
3098	600		1-0-24-144-432 / 6

Plato cambio
Bill holder
Plateau addition
Porta monette
Rechnungshalter



REF.	W(mm)	L(mm)	€	UE / MOQ
5002	170	100		1-0-100-800-1600 / 10

Pala recogemigas
Table crumbler
Ramasse-miettes
Paletta per briciola
Tisch-krümelkehrer



REF.	L(mm)	€	UE / MOQ
3028	280		1-0-24-288-1152 / 6



Alfombra para barra estrecha

Bar mats
Dessus-de-table pour comptoir de bar
Tappetino bar
Gläserabstellmatte

REF.	W(mm)	L(mm)	€	UE / MOQ
8427	85	650		1-0-16-96-768 / 16



Alfombra para barra ancha

Bar mats
Dessus-de-table pour comptoir de bar
Tappetino bar
Gläserabstellmatte

REF.	W(mm)	L(mm)	€	UE / MOQ
8428	300	450		1-0-15-60-240 / 15



Tapón dosificador

Flow pourers
Bec verseur
Tappo versatore dosatore
Dosierausgiesser

REF.	Ø(mm)	H(mm)	€	UE / MOQ
8426	40	110		1-10-100-500-500 / 60



Organizador de bar

Bar organizer
Organisateur de bar
Portacondimenti
Barcaddy

REF.	W(mm)	L(mm)	H(mm)	€	UE / MOQ
8432	148	240	110		1-0-12-24-72 / 12



Recipientes coctelería

Containers for cocktail shaker
Récipients pour cocktails
Portacondimenti
Bar-beilagenbehälte

REF.	W(mm)	L(mm)	H(mm)	€	UE / MOQ
8433	156	492	90		1-0-12-24-72 / 1



NEW



Tabla Corte Negra
Black Cutting Board
Planche à découper Noir
Tagliere Nero
Schwarz Schneidebrett

REF.	WxL cm	ESPEJOR cm	TACOS	€	UE / MOQ
11760	30x20	2	4		1-0-8 / 1
11759	40x30	2	4		1-0-6 / 1

Cuchillo chuletero
Steak knife
Couteau steak
Coltello bistecca
Steakmesser



REF.	HOJA (mm)	L (mm)	€	UE / MOQ
11585	120	230		1-0-24-360-1440 / 24

Cuchillo multiusos micro
Micro serrated utility knife
Couteau multi-usage micro
Coltello multiuso micro
Universalmesser micro



REF.	HOJA (mm)	L (mm)	€	UE / MOQ
11587	100	209		1-0-24-360-1440 / 24

Cuchillo pelador
Peeling knife
Couteau à éplucher
Coltello spellucchino
Schälmesser



REF.	HOJA (mm)	L (mm)	€	UE / MOQ
11586	80	195		1-0-24-360-1440 / 24

INOX
STAINLESS
STEEL
201

Colador inox
Oil strainer
Passoire à huile
Colino per l'olio
Ölsieb

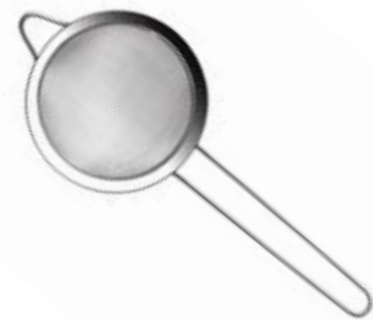

REF.	Ø (mm)	€	UE / MOQ
2884	80		1-0-24-960-1920 / 6
2885	100		1-0-24-960-1920 / 6

ABS
PLASTIC

FOOD
CONTACT



Ribeteador de vasos
Glass rimmer
Bordeuse de verres
Bordatore bicchieri
Bar-kombination salz-zuckerumrand

REF.	Ø (mm)	H (mm)	€	UE / MOQ
8431	160	72		1-0-12-48-144 / 12

PP
POLYPROPYLENE

FOOD
CONTACT

Botella bar
Bar bottle with caps
Bouteille de bar
Contenitore di riserva
Dosier-vorratsbehälter, komplett

REF.	ml	Ø (mm)	H (mm)	€	UE / MOQ
8434	500	95	270		1-0-36-144-576 / 12
8435	1.000	95	330		1-0-48-192-576 / 12
8436	2.000	120	353		1-0-36-108-324 / 6

PP
POLYPROPYLENE



Cesta cubiertos gris
Cutlery dispenser
Récipient à couverts
Portaposate
Besteckbehälter

REF.	W (mm)	L (mm)	H (mm)	€	UE / MOQ
8429	290	525	98		1-0-12-48-144 / 12

FOOD
CONTACT

Accesorios botella bar
Bar bottle accessories
Accessoires pour bouteilles de bar
Accessori per contenitore di riserva
Zubehör für Dosier-vorratsbehälter

REF.	PACK	€	UE / MOQ
8962	PACK 4		1-12-120-360-2520 / 12
8963	PACK 4		1-12-120-360-1080 / 12

8963

PACK 4



PP
POLYPROPYLENE



8962

PACK 4



PC
POLYCARBONATE



BUFFET

BUFFET

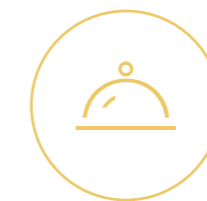

416 CAJAS MADERA
/ WOOD BOXS

420 TABLAS PRESENTACIÓN
/ PRESENTATION BOARDS

422 ACCESORIOS
/ ACCESSORIES

423 JARRAS Y LECHERAS

424 ELEGANT

424 COLOR BUFFET

425 PINZAS

428 KIT SERVIR

430 PINZAS / TONGS



Cajas diseñadas para contener cualquier cubeta o accesorio GN.

Designed to contain whatever pail or GN accessory.

*medidas interiores / internal dimensions

ALTURAS DE CUBETAS GN COMPATIBLES
COMPATIBLE GN TRAY HEIGHTS

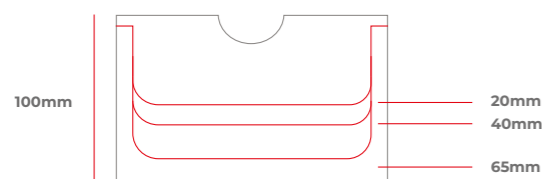

Los accesorios GN quedan encajados en el interior de las cajas, apoyados sobre las esquinas.

GN accessories fit inside the boxes, rested over the corners.



Caja haya
Beech wood box
Cagette en bois
Cassetta legno
Holzbox für behälter

REF.	GN	W(mm)	L(mm)	H(mm)	€	UE / MOQ
7833	1/1	325	530	100		1-0-4-16-24 / 1
7834	1/2	265	325	100		1-0-4-32-52 / 1
7835	1/3	176	325	100		1-0-6-36-72 / 1
7541	1/4	265	162	100		1-0-6-48-144 / 1
7836	2/4	162	530	100		1-0-4-32-48 / 1



Cajas madera y alzadores
Wood box and height adjusters

Soporte alzador cajas madera
Structure height adjuster
Support réhausseur
Telaio per alzata
Strukturierter höhenregulator



REF.	W(mm)	L(mm)	H(mm)	€	UE / MOQ
7838	325	530	100		1-0-4-16-48 / 1

Soporte alzador cajas madera
Structure height adjuster
Support réhausseur
Telaio per alzata
Strukturierter höhenregulator



REF.	W(mm)	L(mm)	H(mm)	€	UE / MOQ
7837	325	530	180		1-0-4-16-16 / 1

Alzador cajas madera
Height adjuster wood boxes
Réhausseur boîte en bois
Supporto per cassetta legno
Höhenregulator für Holzboxen



REF.	W(mm)	L(mm)	H(mm)	€	UE / MOQ
7839	40	40	60		1-4-64-1024-4096 / 4

Pinza servir haya punta redonda
Round head beechwood server tong
Pince à servir en bois à bout rond
Molla servire legno punta rotonda
Holzservierzange, runder kopf



Punta ondulada
Wavy tip

REF.	L(mm)	€	UE / MOQ
7549	305		1-12-72-432-864 / 6

Pinza servir haya punta fina
Slim head beechwood server tong
Pince à servir en bois à bout fin
Molla servire legno a punta
Holzservierzange, dünner kopf



Punta estriada
Ribbed tip

REF.	L(mm)	€	UE / MOQ
7550	305		1-12-72-432-864 / 6





La manera de presentar los alimentos en el buffet de un hotel puede determinar la opinión de los clientes respecto a este.

En Comas te ofrecemos una amplia gama de material profesional para vestir tu buffet. Cajas de madera para cubrir las cubetas GN, gran surtido de pinzas y piezas de servir, jarras, vajillas,...

Descubre todas las combinaciones que puedes conseguir con nuestra selección buffet.

The way of presenting food in a hotel buffet can determine the opinion of the customers about it.

At Comas we offer you a wide range of professional material to dress up your buffet. Wooden boxes to cover GN trays, a wide range of tongs and serving pieces, jugs, crockery,...

Discover all the combinations you can achieve with our buffet selection.

Buffet

NEW



KIT:



VER REFERENCIAS EN PAG 399

REF. KIT	REF. TABLA + REF. ARO	=	DESCRIPCIÓN	€	UE / MOQ
11170	9985 10648		TABLA SLIM S + ARO SLIM BAJO		1-0-0-0-0 / 1
11171	9985 10649		TABLA SLIM S + ARO SLIM ALTO		1-0-0-0-0 / 1
11172	9986 10648		TABLA SLIM M + ARO SLIM BAJO		1-0-0-0-0 / 1
11173	9986 10649		TABLA SLIM M + ARO SLIM ALTO		1-0-0-0-0 / 1
11174	9987 10648		TABLA SLIM L + ARO SLIM BAJO		1-0-0-0-0 / 1
11175	9987 10649		TABLA SLIM L + ARO SLIM ALTO		1-0-0-0-0 / 1
11176	9988 10648		TABLA SLIM XL + ARO SLIM BAJO		1-0-0-0-0 / 1
11177	9988 10649		TABLA SLIM XL + ARO SLIM ALTO		1-0-0-0-0 / 1
11178	9989 10719		TABLA WIDTH S + ARO WIDTH BAJO		1-0-0-0-0 / 1
11179	9989 10720		TABLA WIDTH S + ARO WIDTH ALTO		1-0-0-0-0 / 1
11180	9990 10719		TABLA WIDTH M + ARO WIDTH BAJO		1-0-0-0-0 / 1
11181	9990 10720		TABLA WIDTH M + ARO WIDTH ALTO		1-0-0-0-0 / 1

Madera y pizarra / Wood and slate

Tablas presentación
Presentation boards



Pizarra + Base acacia
Slate board + Acacia base
Ardoise + Socle acacia
Ardesia + Base in acacia
Schiefer + Basis aus akazie

* Acabado brillo / Gloss finish

REF.	L(mm)	W(mm)	H(mm)	€	UE / MOQ
11574	550	345	20		1-0-0-0-0 / 1
11575	340	285	15		1-0-0-0-0 / 1
11576	340	195	15		1-0-0-0-0 / 1
11577	320	320	15		1-0-0-0-0 / 1

SLATE

Pizarra
slate board
Ardoise
Ardesia
Schiefer



REF.	FORMATO	L(mm)	W(mm)	H(mm)	€	UE / MOQ	COMPATIBLE CON / COMPATIBLE WITH:
11002	1/1	530	325	5		1-0-6-0-0 / 4	11005, 11006, 11007, 11573
11003	1/2	325	265	5		1-0-10-0-0 / 4	
11004	1/3	325	175	5		1-0-15-0-0 / 4	
11572		300	300	5		1-0-0-0-0 / 1	



Base madera para pizarra
Base for slate tray
Socle pour plateau ardoise
Base per vassoio in ardesia
Basis für schieferfach



REF.	L(mm)	W(mm)	H(mm)	€	UE / MOQ	COMPATIBLE CON / COMPATIBLE WITH:
11005	550	345	20		1-0-10-0-0 / 4	11002, 11003, 11004, 11572
11006	345	285	15		1-0-20-0-0 / 4	
11007	345	195	15		1-0-4-0-0 / 4	
11573	320	320	15		1-0-0-0-0 / 1	



4 compartimentos para almacenar un servicio de mesa básico.

4 compartments to store a basic table service.

Cómodas asas laterales para un transporte fácil.

Comfortable side handles for easy carrying.



BOROSILICATE

+ RESISTENCIA
RESISTANCE

Jarra cristal tapón corcho
Glass jar with cork lid
Pichet en verre avec couvercle liège
Caraffa in vetro con coperchio in sughero
Glaskrug mit korkdeckel

REF.	Ø(mm)	H(mm)	ml	€	UE / MOQ
10806	105	178	1.200		1-0-24-96-288 / 24
10807	105	255	1.800		1-0-12-48-192 / 24

GLASS

Jarra cristal
Glass bottle
Bouteille en verre
Bottigliette
Glasflasche

REF.	Ø(mm)	H(mm)	ml	€	UE / MOQ
8395	95	270	1.000		1-0-12-96-288 / 12
8396	78	200	500		1-0-24-125-375 / 24

ACACIA WOOD

Cesta cubiertos madera
Wood cutlery dispenser
Panier à couverts en bois
Portaposate legno
Besteck-ablage aus holz

REF.	W(mm)	L(mm)	H(mm)	€	UE / MOQ
8430	325	530	100		1-0-4-16-32 / 1

OAK WOOD

Caja madera portacubiertos
Wood cutlery box
Plateau à couverts en bois
Portaposate legno
Besteckbehal aus holz

REF.	W(mm)	L(mm)	H(mm)	€	UE / MOQ
8473	150	280	70		1-0-6-54-216 / 4

PC POLYCARBONATE **BPA FREE** **FOOD CONTACT**

Vertedor antigoteo
Anti-drip spout

Jarra policarbonato
Polycarbonate jug
Pichet en polycarbonate
Caraffa
Wasserkrug

REF.	Ø(mm)	H(mm)	ml	€	UE / MOQ
8437	110	185	1.000		1-0-12-60-300 / 12
8438	129	220	1.750		1-0-12-36-180 / 12

INOX STAINLESS STEEL 201

Jarra agua
Water jug
Carafe d'eau
Caraffa d'acqua
Wasserkaraffe

REF.	Ø(mm)	H(mm)	ml	€	UE / MOQ
3030	100	145	1.250		1-0-6-48-144 / 6

Espatula servir
Serving spatula
Spatule à service
Spatula arrosto
Servirspatel

REF.	COLOR	L(mm)	€	UE / MOQ
5259	BLACK	280		1-10-50-0-0 / 10
5262	COPPER	280		1-10-50-0-0 / 10
5265	CHAMPAGNE	280		1-10-50-0-0 / 10



Cazo sopa
Soup ladle
Louche à potage
Mestolo sopa
Suppenkelle

REF.	COLOR	L(mm)	€	UE / MOQ
5260	BLACK	265		1-10-50-0-0 / 10
5263	COPPER	265		1-10-50-0-0 / 10
5266	CHAMPAGNE	265		1-10-50-0-0 / 10

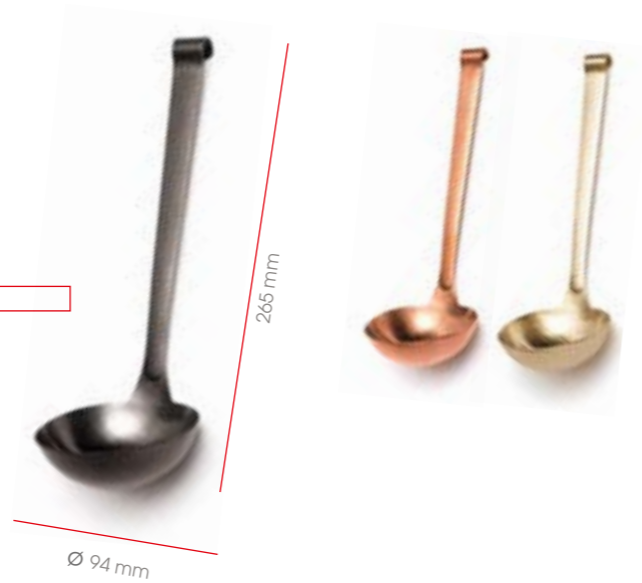

Cuchara servir
Serving spoon
Cuillère à servir
Cucchiaio servir
Servierlöffel

REF.	COLOR	L(mm)	€	UE / MOQ
5261	BLACK	300		1-10-50-0-0 / 10
5264	COPPER	300		1-10-50-0-0 / 10
5267	CHAMPAGNE	300		1-10-50-0-0 / 10



Pinza hielo
Ice tong
Pince à glaçon
Molla ghiaccio
Eiswürflzange

REF.	COLOR	L(mm)	€	UE / MOQ
6767	INOX MIRROR	190		1-10-100-600-600 / 10
6768	PVD BLACK SATIN	190		1-10-100-600-600 / 10
6769	PVD CHAMPAGNE SATIN	190		1-10-100-600-600 / 10
6770	PVD COPPER SATIN	190		1-10-100-600-600 / 10



Pinza servir
Serving tong
Pince à service
Molla arrosto
Servierzange

REF.	COLOR	L(mm)	€	UE / MOQ
6775	INOX MIRROR	240		1-10-100-600-600 / 10
6776	PVD BLACK SATIN	240		1-10-100-600-600 / 10
6777	PVD CHAMPAGNE SATIN	240		1-10-100-600-600 / 10
6778	PVD COPPER SATIN	240		1-10-100-600-600 / 10



Pinza pasteles
Cake tong
Pince à gâteau
Molla dolce
Gebäckzange

REF.	COLOR	L(mm)	€	UE / MOQ
6779	INOX MIRROR	240		1-10-100-600-600 / 10
6780	PVD BLACK SATIN	240		1-10-100-600-600 / 10
6781	PVD CHAMPAGNE SATIN	240		1-10-100-600-600 / 10
6782	PVD COPPER SATIN	240		1-10-100-600-600 / 10



Pinza Spaghetti
Spaghetti tong
Pince spaghetti
Molla spaghetti
Spahettizange

REF.	COLOR	L(mm)	€	UE / MOQ
6771	INOX MIRROR	240		1-10-100-600-600 / 10
6772	PVD BLACK SATIN	240		1-10-100-600-600 / 10
6773	PVD CHAMPAGNE SATIN	240		1-10-100-600-600 / 10
6774	PVD COPPER SATIN	240		1-10-100-600-600 / 10





Diseño del mango especialmente pensado para colgar o apoyar en las bandejas de buffet.

Handle specially designed to be hang or supported on the buffet trays.

Elegant

Kit Servir 18/10 / Serving Kit 18/10

Elegant nace de un diseño propio con la intención de dotar al buffet de unos accesorios de calidad pensados para la practicidad del usuario.

Consta de 13 piezas de servir y 4 tipos de pinzas diseñadas específicamente para cubrir las necesidades del autoservicio en catering y buffet.

Elegant was born from an own design with the intention of providing to the buffet with quality accessories intended for the user practicality.

It is composed of 13 serving pieces and 4 different tongs designed specifically to cover the self-service needs in catering and buffet.



Buffet
ELEGANT COLLECTION



Bandeja reposa utensilio
Utensil rest tray
Plateau repos des ustensiles
Vassoio Riposo per l'utensile
Repository-Werkzeug tablett

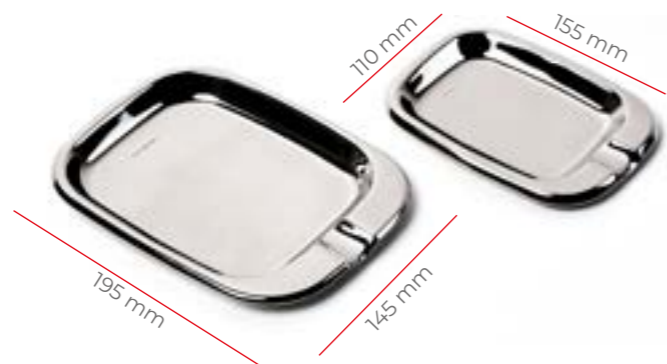

REF.	W(mm)	L(mm)	H(mm)	€	UE / MOQ
7960	145	195	17	35,09	1-10-50-200-1000 / 1
7889	110	155	12	30,29	1-10-50-200-1000 / 1

PACKAGING BLISTER

INOX
STAINLESS
STEEL
304

Elegant

Kit Servir 18/10 / Serving Kit 18/10

PACKAGING BLISTER



				UE	MOQ	L mm	W mm
A	6597	TENEDOR ENSALADA salad fork fourchette salade forchetta insalata salatgabel		1/10/50/200/1000	10	250	60x85
B	6594	CUCHARA RANURADA slotted spoon cuillère à servir percée cucchiaio asolati skimmer		1/10/50/200/1000	10	300	70x98
C	7116	ESPUMADERA skimer écumeoire schiumarola schaumlöffel		1/10/50/200/1000	10	320	Ø 100
D	6589	TENEDOR CARNE meat fork fourchette viande forchetta carne fleischgabel		1/10/50/200/1000	10	300	35x90
E	6590	ESPÁTULA spatula spatule spatula spatel		1/10/50/200/1000	10	280	82x100
F	6592	CUCHARA SPAGHETTI spaguetti spoon cuillère à spaghetti cucchiaio spaguetti spaghetti löffel		1/10/50/200/1000	10	300	73x90
G	6595	PALA REPOSTERÍA cake server pelle à tarte pala torta gebäck schaufel		1/10/50/200/1000	10	300	75x140

					UE	MOQ	L mm	W mm	ml
H	6593	CUCHARA SERVIR serving spoon cuillère à servir cucchiaio servir servierlöffel		1/10/50/200/1000	10	300	70x98		
I	6599	CUCHARA ENSALADA salad spoon cuillère salade cucchiaio salate salatiöfel		1/10/50/200/1000	10	250	60x85		
J	7958	CAZO SALSA sauce ladle cuillère à sauce mestolino salsa soßenkelle		1/10/50/200/1000	10	295	Ø 60	30	
K	6607	CAZO SALSA sauce ladle cuillère à sauce mestolino salsa soßenkelle		1/10/50/200/1000	10	260	Ø 60	30	
L	7959	CUCHARA ARROZ rice spoon cuillère à riz cucchiaio riso reislöffel		1/10/50/200/1000	10	355	75x100		
M	6596	CUCHARA ARROZ rice spoon cuillère à riz cucchiaio riso reislöffel		1/10/50/200/1000	10	280	75x100	30	
N	6606	CAZO SOPA soup ladle louche à potage mestolo sopa suppenkelle		1/10/50/200/1000	10	310	Ø 94	120	
O	6591	CAZO SOPA soup ladle louche à potage mestolo sopa suppenkelle		1/10/50/200/1000	10	265	Ø 94	120	

INOX STAINLESS STEEL 201

Pinza servir PVC
Serving PVC tong
Pince à servir pvc
Pinze da servizio pvc
Vorlegezange pvc



PVC aislante para una mejor sujeción.
PVC insulator for a better clamping.

REF.	L(mm)	€	UE / MOQ
2870	240		1-24-120-480-960 / 6

INOX STAINLESS STEEL 201

Pinza multiusos PVC
Multiuse PVC tong
Pince multi-usage
Pinze multiuso
Mehrzweckzange



REF.	L(mm)	€	UE / MOQ
2871	240		1-24-120-480-960 / 6
2872	300		1-24-120-480-960 / 6
2873	350		1-24-120-480-960 / 6

INOX STAINLESS STEEL 201

Pinza buffet PVC
Buffet PVC tong
Pince à buffet pvc
Pinze da buffet pvc
Buffetzange pvc



REF.	L(mm)	€	UE / MOQ
2868	235		1-24-120-480-960 / 6

INOX STAINLESS STEEL 201

Pinza ensalada PVC
Salad PVC tong
Pince à salade pvc
Pinze per insalata pvc
Salatzange pvc



REF.	L(mm)	€	UE / MOQ
2867	240		1-24-120-480-960 / 6

INOX STAINLESS STEEL 201

Pinza oval PVC
Oval PVC tong
Pince ovale pvc
Pinze ovale pvc
Ovalzange pvc



REF.	L(mm)	€	UE / MOQ
2869	240		1-24-120-480-960 / 6



INOX STAINLESS STEEL 304

Pinza servir extra
Serving extra tong
Pince à servir extra
Pinze da servizio extra
Vorlegezange extra

REF.	L(mm)	€	UE / MOQ
0065	240		0-10-25-200-400 / 6



INOX STAINLESS STEEL 304

Pinza repostería extra
Pastry extra tong
Pince à pâtisserie extra
Molla dolce extra
Gebäckzange extra

REF.	L(mm)	€	UE / MOQ
0066	240		0-10-25-200-400 / 6



PACKAGING HANG TAG

INOX STAINLESS STEEL 201

Pinza luxe
Luxe tong
Pince luxe
Pinze luxe
Zange luxe



Punta ondulada que asegura una mejor sujeción de los alimentos

Curled tip ensures a better fastening for the foods.

Sistema de bloqueo para mantener la pinza cerrada.

Block system to keep closed the tong.

REF.	L(mm)	€	UE / MOQ
2874	240		1-24-120-480-960 / 6
2875	300		1-24-120-480-960 / 6
2876	350		1-24-120-480-960 / 6

Pinza tijera ensalada
Salad scissor tong
Pince-ciseaux à salade
Forbice insalata
Salatschere



INOX STAINLESS STEEL 304

REF.	L(mm)	€	UE / MOQ
3122	210		1-0-100-200-400 / 6

Pinza tijera tarta
Tart scissor tong
Pince-ciseaux à tarte
Forbice torta
Tortezange



INOX STAINLESS STEEL 304

REF.	L(mm)	€	UE / MOQ
3124	240		1-0-100-200-400 / 6

Pinza grill
Grill tong
Pince à grill
Pinze grill
Grillzange



INOX STAINLESS STEEL 430

REF.	L(mm)	€	UE / MOQ
2881	320		1-24-120-480-960 / 6

Pinza multiusos extra
Multiuse extra tong
Pince multi-usage extra
Pinze multiuso extra
Mehrzweckzange extra



INOX STAINLESS STEEL 201

REF.	L(mm)	€	UE / MOQ
2877	240		1-24-120-480-960 / 6
2878	300		1-24-120-480-960 / 6
2879	350		1-24-120-480-960 / 6

Pinza tijera dulces
Cake scissor tong
Pince-ciseaux à gâteau
Forbice dolce
Kuchenzange



INOX STAINLESS STEEL 304

REF.	L(mm)	€	UE / MOQ
3123	200		0-10-100-200-400 / 6

Pinza ensalada muelle
Salad spring tong
Pince salade
Molla salate
Salatzange



INOX STAINLESS STEEL 201

REF.	L(mm)	€	UE / MOQ
5654	240		1-0-100-800-1600 / 6

Buffet

Pinzas /Tongs



PVC aislante para una mejor sujeción.

PVC insulator for a better clamping.

Estas pinzas monobloc fabricadas en acero inoxidable son funcionales tanto en buffet como en cocina. Su mango de PVC en distintos colores permite controlar la contaminación cruzada de los alimentos.

These monobloc tongs in stainless steel are just as functional for service at a buffet as in the kitchen. Their distinctively coloured PVC handles makes it easy to control cross-contamination between different foods.

INOX
STAINLESS
STEEL
201

PVC

3
MEDIDAS
SIZES



REF.	COLOR	L(mm)	€	UE/MOQ
10677	○	250		1-10-100 / 10
10678	●	250		1-10-100 / 10
10684	●	250		1-10-100 / 10
10685	●	250		1-10-100 / 10
10686	●	250		1-10-100 / 10
10687	●	250		1-10-100 / 10
10688	●	250		1-10-100 / 10
10701	○	300		1-10-100 / 10
10702	●	300		1-10-100 / 10
10703	●	300		1-10-100 / 10
10704	●	300		1-10-100 / 10
10705	●	300		1-10-100 / 10
10706	●	300		1-10-100 / 10
10707	●	300		1-10-100 / 10
10708	○	400		1-10-60 / 10
10709	●	400		1-10-60 / 10
10710	●	400		1-10-60 / 10
10711	●	400		1-10-60 / 10
10712	●	400		1-10-60 / 10
10713	●	400		1-10-60 / 10
10714	●	400		1-10-60 / 10



Pinza buffet
Buffet tong
Pince à buffet
Pinze buffet
Buffetzange



INOX STAINLESS STEEL 201

REF.	L(mm)	€	UE / MOQ
2883	240		1-24-120-480-960 / 6

Pinza spaghetti
Spaghetti tong
Pince spaghetti
Molla spaghetti
Spagettizange



INOX STAINLESS STEEL 201

REF.	L(mm)	€	UE / MOQ
1831	240		1-0-100-1200-3600 / 6

Pinza hielo muelle inox
Spring ice tong
Pince glaçon à ressort
Molla ghiaccio
Eiswürfelzange



INOX STAINLESS STEEL 430

REF.	L(mm)	€	UE / MOQ
3476	190		1-0-102-1326-3978 / 6

Pinza hielo buffet
Buffet ice tong
Pince à glaçon buffet
Molla ghiaccio buffet
Eiswürfelzange buffet



INOX STAINLESS STEEL 201

REF.	L(mm)	€	UE / MOQ
5276	180		1-120-480-800-2400 / 6

Pinza ensalada
Salad tong
Pince à salade
Pinze insalata
Salatzange



INOX STAINLESS STEEL 201

REF.	L(mm)	€	UE / MOQ
2882	240		1-24-120-480-960 / 6

Pinza repostería extra
Extra cake tong
Pince à gâteau extra
Molla a dolce extra
Kuchenzange extra



INOX STAINLESS STEEL 201

REF.	L(mm)	€	UE / MOQ
2152	240		1-0-100-60-1800 / 6

Pinza azúcar
Sugar tong
Pince à sucre
Molla zucchero
Zuckerzange



INOX STAINLESS STEEL 201

REF.	L(mm)	€	UE / MOQ
4962	125		1-0-250-1680-5040 / 6

Pinza fiambres extra
Cold meat extra tong
Pince à charcuterie extra
Molla affettati extra
Aufschnittzange extra



INOX STAINLESS STEEL 304

REF.	L(mm)	€	UE / MOQ
3121	210		1-0-100-600-1800 / 6

Pinza pan extra
Extra bread tong
Pince à pain extra
Molla pane extra
Brotzange extra



INOX STAINLESS STEEL 201

REF.	L(mm)	€	UE / MOQ
3120	240		1-0-100-200-400 / 6

Pinza servir
Serving tong
Pince de service
Molla arrosto
Servierzange



INOX STAINLESS STEEL 201

REF.	L(mm)	€	UE / MOQ
2151	245		1-24-120-480-960 / 6

Pinza hielo
Ice tong
Pince à glaçon
Molla ghiaccio
Eiswürfelzange



INOX STAINLESS STEEL 201

REF.	L(mm)	€	UE / MOQ
2153	190		1-10-100-700-2800 / 6

Pinza hielo extra
Extra ice tong
Pince à glace extra
Pinze ghiaccio extra
Eiszange extra



INOX STAINLESS STEEL 201

REF.	L(mm)	€	UE / MOQ
2880	210		1-60-120-480-960 / 6

CATERING

CATERING



438 AHUMADORES / SMOKERS

442 LES ESSENCES

- 444 BANDEJA GN 1/1
- 446 BANDEJA LED
- 448 BANDEJAS
- 450 ROOM SERVICE
- 451 CUBREBANDEJAS
- 452 VAJILLA PORCELANA
- 454 SET CUBERTERÍA
- 456 CUCHARAS DEGUSTACIÓN
- 458 SOPORTES
- 460 FINGER FOOD



PACK 6 BOROSILICATE

Campana ahumados sin válvula
Smoked hood without valve
Capot fumé sans valve
Cappa fumé senza valvola
Geräucherte Haube ohne Ventil

REF.	W(mm)	L(mm)	H(mm)	Ø(mm)	€
11504	200	300	150	90	
11500	320	460	140	140	
11502	420	610	180	180	



PACK 6 BOROSILICATE

Campana ahumados con válvula
Smoked hood with valve
Capot fumé avec valve
Cappa fumé con valvola
Geräucherte Haube mit Ventil

REF.	W(mm)	L(mm)	H(mm)	Ø(mm)	€
11503	200	300	150	90	
11499	320	460	140	140	
11501	420	610	180	180	



SERRÍN DE RAÍZ DE OLIVO / ALMENDRO

OLIVE / ALMOND ROOT SAWDUST

FRESCO FRESH

NEW

Bbq Flavour
Bbq Flavour
Bbq Flavour
Bbq Flavour
Bbq-Aroma

REF.	PESO(kg)	€	UE / MOQ
11977	0,150		1-0-0-0-0 / 1



Envasamos según pedido para garantizar la máxima frescura y preservar todos los beneficios del producto.

We pack to order to guarantee maximum freshness and preserve all the benefits of the product.



Ahumador aromatizador profesional
Professional flavouring smoker
Fumeur d'arôme professionnel
Affumicatore per aromi professionale
Professioneller aroma smoker

REF.	L(mm)	€
11496	270	



Ahumador aromatizador 007 black edition
Flavourer smoker 007 black edition
Arôme fumeur 007 black edition
Aroma affumicatore 007 black edition
Aroma smoker 007 black edition

REF.	L(mm)	€
11510	220	



Ahumador aromatizador 007
Flavourer smoker 007
Arôme fumeur 007
Aroma affumicatore 007
Aroma smoker 007

REF.	L(mm)	€
11498	220	



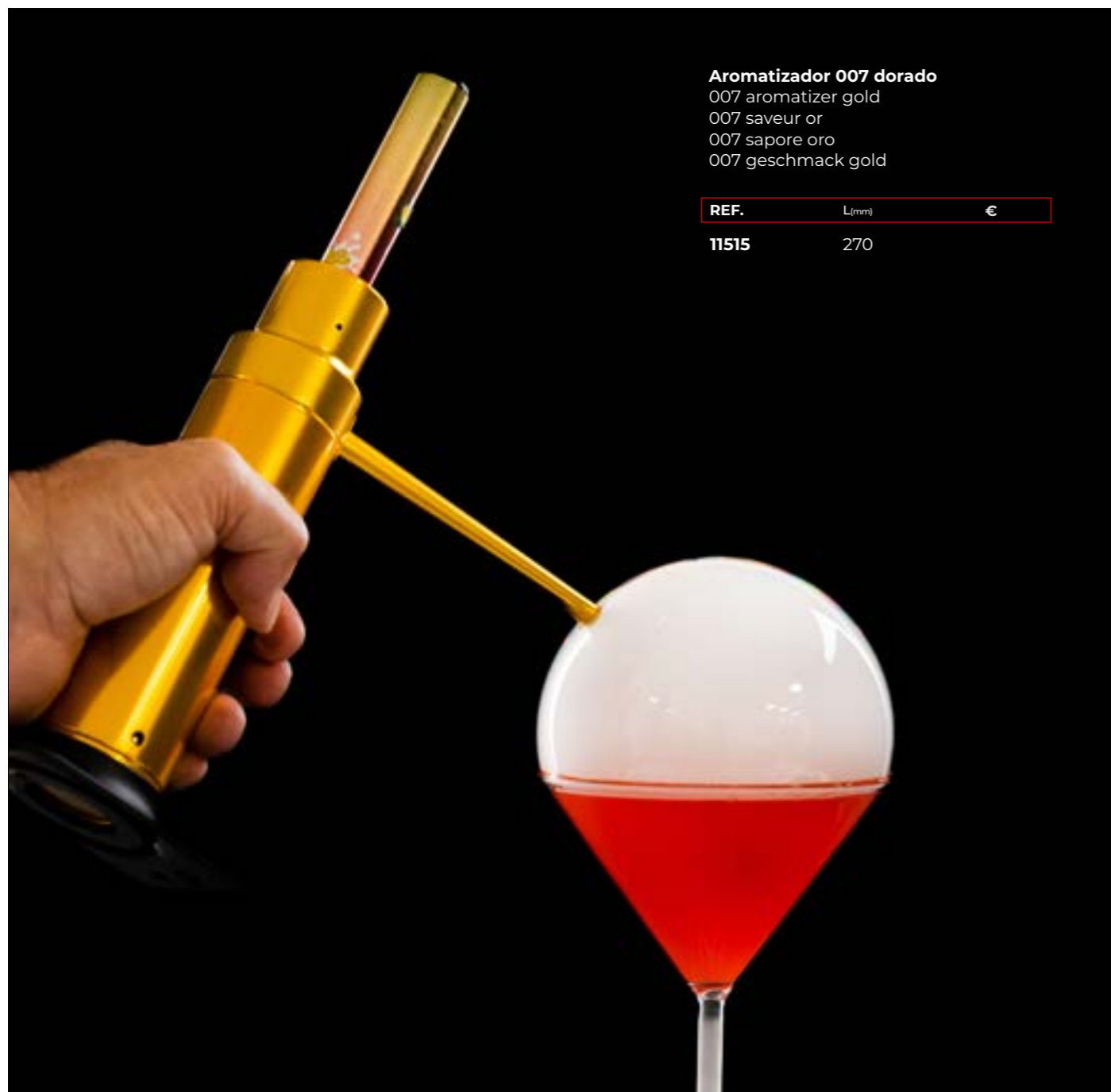

Aromatizador 007 dorado
 007 aromatizer gold
 007 saveur or
 007 sapore oro
 007 geschmack gold

REF.	L(mm)	€
11515	270	



Aromatizador 007 azul
 007 aromatizer blue
 007 saveur bleu
 007 sapore blu
 007 geschmack blau



REF.	L(mm)	€
11513	270	



Aromatizador 007 negro
 007 aromatizer black
 007 saveur noir
 007 sapore nero
 007 geschmack schwarz



REF.	L(mm)	€
11514	270	



Guía uso de los vaps.

Carga vapor 007 flavour VAP
 007 flavoured vapor cartridges
 007 cartouches de vapeur aromatisées
 007 cartucce di vapore al gusto
 007 aromatisierte dampfkartuschen



REF.	AROMA	€
11516	PIÑA / PINEAPPLE	
11517	ARANDANOS / BLUEBERRIES	
11518	MENTA / MINT	
11519	MANZANA VERDE / GREEN APPLE	
11520	PLATANO / BANANA	
11521	CITRONELA / LEMONGRASS	
11522	NEUTRO / NEUTRAL	
11523	CHOCOLATE CAFÉ / CHOCOLATE COFFEE	
11524	CANELA / CINNAMON	
11525	LAVANDA / LAVANDER	
11527	PURO HABANO / PURE HABANO	

Gel pompas 007 flavour
 Gel bubbles 007 flavour
 Gel pour les bulles 007 flavour
 Gel per bolle 007 flavour
 Gel für blasen 007 flavour



REF.	ml	€
11628	200	



Kit campana con valvula
 Dome with valve kit
 Dôme avec kit vanne
 Cupola con kit valvola
 Dome mit ventilsatz



REF.	€
11511	

Ahumadores Smokers

007 flavour VAP rellenable 5ml 10pcs
 007 flavored refillable 5ml 10pcs
 007 aromatisé rechargeable 5ml 10pcs
 007 aromatizzato ricaricabile 5ml 10pz
 007 aromatisiert nachfüllbar 5ml 10stk



REF.	€
11526	

Filtros Aladin XL
 Aladin filters XL
 Écrans Aladin XL
 Aladin Schermi XL
 Aladin Bildschirme XL



REF.	Ø(mm)	€
11497	25	

CD Aladin
 CD Aladin
 CD Aladin
 CD Aladino
 CD Aladin



REF.	Ø(mm)	€
11507	120	



Kit campana sin valvula
 Dome without valve kit
 Dôme sans kit vanne
 Cupola senza kit valvola
 Dome ohne ventilsatz



REF.	€
11512	

Les Essences

Les Essences

Ahumadores / Smokers



Premio a la mejor innovación de producto.
Award for best product innovation.

Comas presenta LES ESSENCES, una colección pensada para vivir la experiencia de un catering exclusivo, con piezas de diseño, de líneas actuales, que se complementan entre ellas para crear una colección única.

Junto a profesionales del sector, hemos planteado las principales necesidades de un catering, hemos estudiado minuciosamente las formas, las medidas y las proporciones para que el conjunto sea práctico y versátil.

Cada pieza es una y múltiplo de la siguiente con lo que se consigue una perfecta disposición en sala, donde el equilibrio y la elegancia llenan el espacio, así como un fácil almacenaje tras cada pase.

Comas presents LES ESSENCES, an exclusive catering collection, with trendy pieces using modern forms, that all complement each other to form a unique collection.

Working along with professionals in the industry, we have identified the essential needs of catering and studied form, dimensions and proportion in minute detail to make the whole collection practical and versatile.

Each piece is at once single and a multiple of the next so that they can be arranged perfectly in any room and fill any space with balance and elegance and are easy to store after each service.



GN 1/1
LES ESSENCES COLLECTION



**Conoce
la bandeja
GN 1/1**

Les Essences
Bandeja GN 1/1 / GN 1/1 Tray



Apilable para un mejor almacenaje. Altura máxima de tu elaboración 74mm
Stackable for easy storage. Maximum height of your workmanship 74mm

Aluminio ligero, facilita el transporte y soporta horneados de hasta 250 °C

Lightweight aluminium, easy to transport and withstands baking temperatures up to 250°C.

Su ancho de 325 mm encaja tanto en las guías de los hornos industriales como en las cajas de transporte GN.

Its 325 mm width fits both industrial oven rails and GN transport boxes.

Grueso de 1,5mm para una mayor resistencia.

1.5mm thick for extra strength.

Ala externa que permite almacenar las bandejas en los trolley.

External wing for storing trays on trolleys.

*** Nueva altura para elaboraciones de hasta 74 mm**

New height for processing of up to 74 mm

4 PASOS CON UNA SOLA BANDEJA / 4 STEPS WITH ONLY ONE TRAY

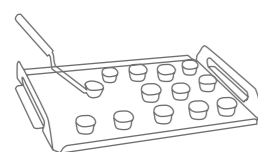

PREPARACIÓN
PREPARATION

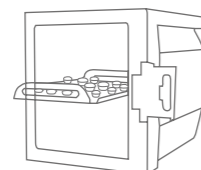

TRANSPORTE
TRANSPORT

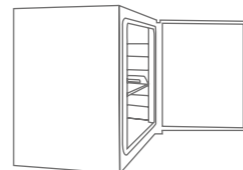

COCCIÓN
COOKING

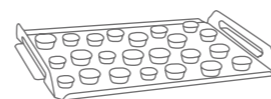

PASE
PASS



COLOR: SILVER

COLOR: PURE CARBON



Bandeja GN 1/1
Tray GN 1/1
Plateau silver GN 1/1
Vassoio silver GN 1/1
Silver tablett GN 1/1

REF.	COLOR	W(mm)	L(mm)	H(mm)	€	UE / MOQ
11143	●	325	530	74		1-4-16-48-96 / 4
11144	●	325	530	74		1-4-16-48-96 / 4



Adaptable a cajas de transporte con guías.
Adaptable to transport boxes with guides.



Adaptable a hornos industriales y carros GN.
Adaptable to industrial ovens and GN trolleys.



Cubrebandeja silicona GN 1/1
Silicon tray cover GN 1/1
Couvercle plateau silicone GN 1/1
Coperchio vassoio in silicone GN 1/1
Tablett mit silikonbeschichtung GN 1/1

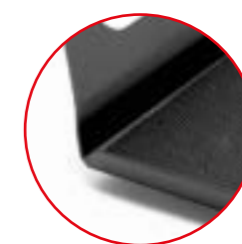

REF.	W(mm)	L(mm)	€	UE / MOQ
10785	325	530		1-4-64-0-0 / 4

Conoce BAHIGÜELL en la página: 510
More about BAHIGÜELL in page: 510

LED LIGHT TRAY
LES ESSENCES COLLECTION



Luz regulable en 3 intensidades.
Light adjustable in 3 intensities.



No sumergible.
Lavable con paño húmedo.

Non-submersible.
Washable with a damp cloth.



Botón táctil de apagado y encendido.
Touch button for power on/off.



Batería recargable por USB.
USB rechargeable battery.



Patas de silicona para una mayor fijación en la superficie.
Silicone feet for a better fixation on the surface.

4h
de duración
endurance



Adaptable a bandeja GN 1/1
Compatible with GN 1/1

Base Led GN 1/1
Led board tray GN 1/1
Support led plateau GN 1/1
Supporto led per teglie GN 1/1
GN 1/1 tablett led

REF.	W(mm)	L(mm)	€	UE / MOQ
10784	325	530		1-0-1/1

Lámina metacrilato protector.
Methacrylate protective sheet
Feuille protectrice méthacrylate
Foglio protettivo in metacrilato
Methacrylat schutzblatt

REF.	W(mm)	L(mm)	€	UE / MOQ
10808	325	530		1-0-1/1



Efecto láminas acetato.

Les Essences

Bandeja iluminación Led / Led Light Tray



Lámina de metacrilato protectora.
Apto para contacto alimentario.

Protective methacrylate sheet.
Suitable for food contact.

Base LED GN 1/1.

Led tray GN 1/1.



Lámina personalizable para cualquier emplatado.

Customisable film for any dish.

Bandeja GN 1/1 Les Essences.

Tray GN 1/1 Les Essences.

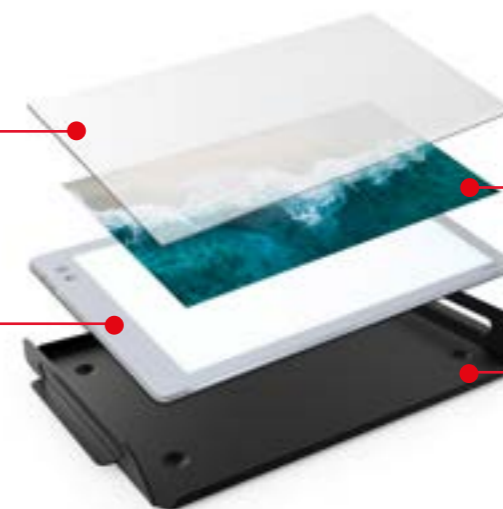

Lámina acetato personalizable
Customisable acetate film
Film acétate personnalisable
Pellicola di acetato personalizzabile
Individuell gestaltbare Acetatfolie

REF.	W(mm)	L(mm)	MODELO	€	UE / MOQ
10786	297	420	A - AGUA		1-0-6 / 6
10799	297	420	B - FUEGO		1-0-6 / 6
10800	297	420	C - TIERRA		1-0-6 / 6
10801	297	420	D - AIRE		1-0-6 / 6
* 10801	297	420	E - PERSONALIZADO		1-0-6 / 6

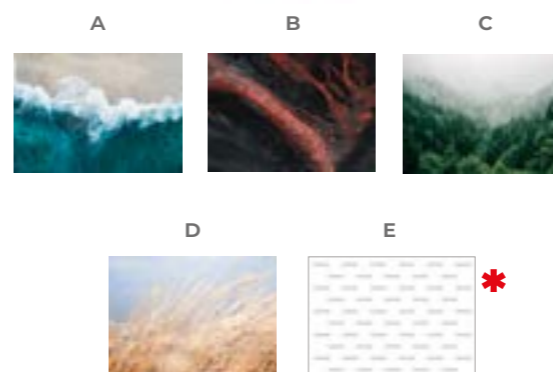
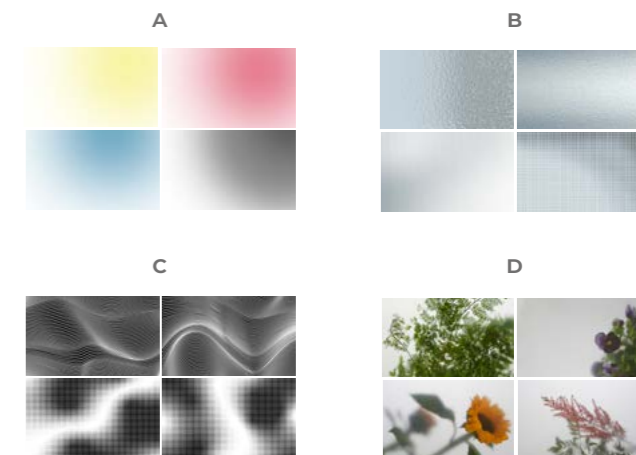

Pack 4 lámina acetato
Customisable acetate film
Film acétate personnalisable
Pellicola di acetato personalizzabile
Individuell gestaltbare Acetatfolie

REF.	W(mm)	L(mm)	MODELO	€	UE / MOQ
10975	297	420	A - CHROMATIQUE		1-0-6-0-0 / 6
10976	297	420	B - GLASSIER		1-0-6-0-0 / 6
10977	297	420	C - KONTRAST		1-0-6-0-0 / 6
10978	297	420	D - PLANTS		1-0-6-0-0 / 6



Bandeja rectangular pequeña

Catering tray
Plateau de présentation
Vassoio catering
Catering tablett



COLOR:
SOFT ARGENTO



COLOR:
PURE CARBON

REF.	COLOR	W(mm)	L(mm)	H(mm)	€	UE / MOQ
7579	●	150	270	69		1-4-16-96-288 / 4
7588	●	150	270	69		1-4-16-96-288 / 4
7438	SILICONA SILICONE	145	265			1-4-64-1024-2048 / 4
7845	CORCHO CORK	145	265			1-4-64-360-1080 / 4

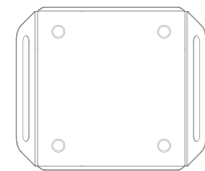

Bandeja cuadrada

Catering tray
Plateau de présentation
Vassoio catering
Catering tablett



COLOR:
SOFT ARGENTO



COLOR:
PURE CARBON

REF.	COLOR	W(mm)	L(mm)	H(mm)	€	UE / MOQ
7581	●	285	270	69		1-4-16-96-192 / 4
7590	●	285	270	69		1-4-16-96-192 / 4
7440	SILICONA SILICONE	280	265			1-4-64-512-1536 / 4
7847	CORCHO CORK	280	265			1-4-64-360-1080 / 4



Asas y barandas oblicuas para facilitar el apilado.

Oblique handles and handrails facilitates easy stacking.



Pequeña elevación de 5mm que evita que la bandeja se apoye directamente en la mesa y lo hace visualmente más ligero.

Small elevation of 5mm avoids direct contact with the table and makes it visually lighter.



Bandeja rectangular estrecha

Catering tray
Plateau de présentation
Vassoio catering
Catering tablett



COLOR:
SOFT ARGENTO



COLOR:
PURE CARBON

REF.	COLOR	W(mm)	L(mm)	H(mm)	€	UE / MOQ
7580	●	150	525	69		1-4-16-32-160 / 4
7589	●	150	525	69		1-4-16-32-160 / 4
7439	SILICONA SILICONE	145	520			1-4-64-1024-3072 / 4
7846	CORCHO CORK	145	520			1-4-64-360-1080 / 4



Bandeja rectangular grande

Catering tray
Plateau de présentation
Vassoio catering
Catering tablett



COLOR:
SOFT ARGENTO



COLOR:
PURE CARBON

REF.	COLOR	W(mm)	L(mm)	H(mm)	€	UE / MOQ
7582	●	285	525	69		1-4-16-48-96 / 4
7591	●	285	525	69		1-4-16-48-96 / 4
7441	SILICONA SILICONE	280	520			1-4-64-512-1536 / 4
7848	CORCHO CORK	280	520			1-4-64-360-1080 / 4



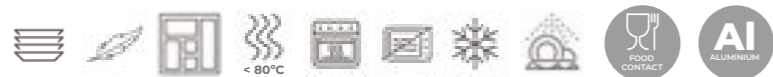

Bandeja Room service
Room service tray
Plateau à servir
Vassoio servizio in camera
Zimmerservice tablett



REF.	COLOR	W(mm)	L(mm)	H(mm)	€	UE / MOQ
7930	●	385	520	120		1-4-16-48-96 / 4
7931	CORCHO CORK	380	515			1-4-64-192-336 / 4



Cubrebandeja silicona
Silicone tray cover
Couvercle plateau silicone
Coperchio vassoio in silicone
Tablett mit silikonbeschichtung



REF.	W(mm)	L (mm)	Para ref. / For ref.	€	UE / MOQ
7438	145	265	7579 - 7588		1-4-64-1024-2048 / 4
7439	145	520	7580 - 7589		1-4-64-1024-3072 / 4
7440	280	265	7581 - 7590		1-4-64-512-1536 / 4
7441	280	520	7582 - 7591		1-4-64-512-1536 / 4



Cubrebandeja corcho rectangular
Cork tray cover
Couvre plateau en liège
Coperchio per vassoio in sughero
Kork-auflage für tablett



REF.	W(mm)	L (mm)	Para ref. / For ref.	€	UE / MOQ
7845	145	265	7579 - 7588		1-4-64-360-1080 / 4
7846	145	520	7580 - 7589		1-4-64-360-1080 / 4
7847	280	265	7581 - 7590		1-4-64-360-1080 / 4
7848	280	520	7582 - 7591		1-4-64-360-1080 / 4
7931	380	515	7930		1-4-64-192-336 / 4

Catering
LES ESSENCES COLLECTION



Porcelana de alta calidad fabricada en 2 tiempos de cocción a más de 1200°C, que le proporciona impermeabilidad, resistencia y suavidad al tacto.

High Quality porcelain made in 2 times firing beyond 1200°C provides impermeability, resistance and soft touch.



Les Essences

Vajilla porcelana / Porcelain tableware

Versatilidad, composición, orden, apilabilidad, practicidad... El sistema modular de la vajilla LES ESSENCES, facilita el trabajo de un servicio de catering.

Versatility, composition, order, stackability, practicality... The modular system LES ESSENCES, facilitates the work in a catering service.

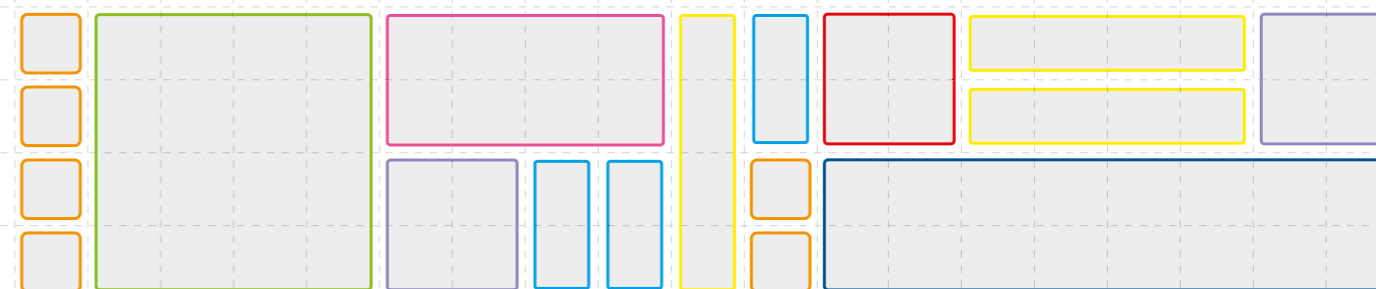

Plato postre
Dessert plate
Assiette à dessert
Piatto dolce
Dessert platte



REF.	W(mm)	L(mm)	H(mm)	€	UE / MOQ
7681	120	120	18		1-4-64-360-1080 / 4

Barquillo
Wafer
Barquette
Vassoietto fondo
Waffel



REF.	W(mm)	L(mm)	H(mm)	€	UE / MOQ
7680	60	240	18		1-4-64-360-1080 / 4

Plato llano
Dinner plate
Assiette plate
Piatto piano
Teller



REF.	W(mm)	L(mm)	H(mm)	€	UE / MOQ
7672	240	240	13		1-4-24-360-1080 / 4

Bandeja simple
Simple tray
Plateau simple
Vassoio semplice
Tablett



REF.	W(mm)	L(mm)	H(mm)	€	UE / MOQ
7671	120	240	15		1-4-48-360-1080 / 4



Plato Half
Half Dessert Plate
Assiette
Dessert Half
Piatto Dolce Half
Dessertteller Half



REF.	W(mm)	L(mm)	H(mm)	€	UE / MOQ
11972	60	120	18		0-6-144-0-0 / 6



Vaso
Cup
Verre
Bicchiere
Becher



REF.	W(mm)	L(mm)	H(mm)	ml	€	UE / MOQ
7679	60	60	60	70		1-4-72-360-1080 / 4

Bol
Bowl
Bol
Ciotola
Quadratische schale



REF.	W(mm)	L(mm)	H(mm)	ml	€	UE / MOQ
7670	120	120	60	400		1-4-48-360-1080 / 4

Bandeja doble
Double tray
Plateau double
Vassoio doppio
Doppeltes tablett



REF.	W(mm)	L(mm)	H(mm)	€	UE / MOQ
7673	120	480	13		1-4-24-360-1080 / 4



PACKAGING
CUSTOM BOX



Cuchillo Vintage
Vintage Knife
Couteau Vintage
Coltello Vintage
Vintage-Messer



REF.	L(mm)	€	UE / MOQ
11662	115		0-12-120-0-0 / 12

Tenedor Vintage
Vintage Fork
Fourchette Vintage
Forchetta Vintage
Vintage-Gabel



REF.	L(mm)	€	UE / MOQ
11663	117		0-12-120-0-0 / 12

Tenedor Mini Vintage
Vintage Mini Fork
Fourchette Mini Vintage
Forchetta Mini Vintage
Mini-Vintage-Gabel



REF.	L(mm)	€	UE / MOQ
11664	72		0-12-120-0-0 / 12

Pincho Vintage
Vintage Skewer
Brochette Vintage
Set Da Aperitivo Vintage
Vintage-Spiess



REF.	L(mm)	€	UE / MOQ
11665	104		0-12-120-0-0 / 12

Soporte Cubiertos Individual
Cutlery Rest Individual
Support-Couverts Individuel
Supporto Posate Individuale
Besteckhalter Einzeln



REF.	W(mm)	L(mm)	H(mm)	€	UE / MOQ
11667	60	54	15		0-12-240-0-0 / 12

Soporte Cubiertos Triple
Cutlery Rest Triple
Support-Couverts Triple
Supporto Posate Triplo
Besteckhalter Mit Drei Fächern



REF.	W(mm)	L(mm)	H(mm)	€	UE / MOQ
11666	60	145	15		0-4-80-0-0 / 4



Diseño especialmente pensado para la degustación de aperitivos rápidos durante un catering.

Designed specially to tasting snacks during a catering.



Descubre más.



Cuchara arrastre
Drag spoon
Cuillère à glisser
Cucchiaio drag
Drag-probierlöffel

REF.	COLOR	L(mm)	€	UE / MOQ
7568	PERFORADA VINTAGE	75		0-12-120-3960-15840 / 12
7569	VINTAGE	75		0-12-120-3960-15840 / 12
7570	VINTAGE PVD INTENSE GOLD	75		0-12-120-3960-15840 / 12
7571	VINTAGE PVD PURE CARBON	75		0-12-120-3960-15840 / 12



Cuchara acompañamiento
Accompaniment spoon
Cuillère d'accompagnement
Cucchiaio per accompagnamento
Begleitung probierlöffel

REF.	COLOR	L(mm)	€	UE / MOQ
7564	PERFORADA VINTAGE	120		0-12-120-3960-15840 / 12
7565	VINTAGE	120		0-12-120-3960-15840 / 12
7566	VINTAGE PVD INTENSE GOLD	120		0-12-120-3960-15840 / 12
7567	VINTAGE PVD PURE CARBON	120		0-12-120-3960-15840 / 12



Cuchara aperitivos de montaje
Appetizer assembly spoon
Assemblage du cuillères apéritif
Assemblaggio cucchiaio antipasto
Probierlöffel-montage-vorspeise

REF.	COLOR	L(mm)	€	UE / MOQ
7572	PERFORADA VINTAGE	71		0-12-120-3960-15840 / 12
7573	VINTAGE	71		0-12-120-3960-15840 / 12
7574	VINTAGE PVD INTENSE GOLD	71		0-12-120-3960-15840 / 12
7575	VINTAGE PVD PURE CARBON	71		0-12-120-3960-15840 / 12



Cuchara aperitivos de montaje plana
Flat appetizer assembly spoon
Cuillère plate pour assablage
Cucchiaio piatto per antipasti da assemblato
Flacher snacklöffel

REF.	COLOR	L(mm)	€	UE / MOQ
7576	VINTAGE	85		0-12-120-3960-15840 / 12
7577	VINTAGE PVD INTENSE GOLD	85		0-12-120-3960-15840 / 12
7578	VINTAGE PVD PURE CARBON	85		0-12-120-3960-15840 / 12



Soporte conos
Cones support
Support cornets
Supporto per coni finger food
Auflage für kegel



REF.	COLOR	W(mm)	L(mm)	H(mm)	€	UE / MOQ
7586	●	120	240	40		1-4-16-192-336 / 4
7595	●	120	240	40		1-4-16-192-336 / 4



Soporte piruletas
Lollipops support
Support sucettes
Supporto spiedini finger food
Display für lollies

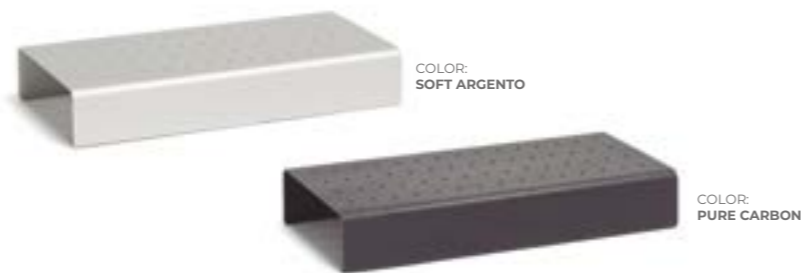

REF.	COLOR	W(mm)	L(mm)	H(mm)	€	UE / MOQ
7585	●	120	240	40		1-4-16-192-336 / 4
7594	●	120	240	40		1-4-16-192-336 / 4



Bandeja madera roble
Oak wood tray
Plateau en chêne
Vassoio legno quercia
Eichenholz tablett



Se vende por separado.
Sold separately.

REF.	W(mm)	L(mm)	H(mm)	€	UE / MOQ
7587	120	240	10		1-4-16-192-512 / 4

Conoce BAHIGÜELL en la página: 510
More about BAHIGÜELL in page: 510



PACKAGING
CUSTOM BOX



Soporte para tacos
Tacos support
Plat support à tacos
Supporto per tacos
Auflage für tacos



REF.	COLOR	W(mm)	L(mm)	H(mm)	€	UE / MOQ
7583	●	120	240	40		1-4-16-192-512 / 4
7592	●	120	240	40		1-4-16-192-512 / 4



Soporte para brochetas
Skewers support
Support brochette
Supporto per spiedini lunghi
Spießhalter



REF.	COLOR	W(mm)	L(mm)	H(mm)	€	UE / MOQ
7584	●	60	240	30		1-4-16-320-1280 / 4
7593	●	60	240	30		1-4-16-320-1280 / 4



PACKAGING
CUSTOM BOX

El término "finger food" se refiere a alimentos que se pueden consumir con las manos, sin la necesidad de cubiertos. Estos platillos suelen ser pequeños, fáciles de comer y están diseñados para ser saboreados en una o dos mordidas.

Siguiendo este concepto, Comas ha creado una colección de cubiertos de tamaño reducido, como una prolongación de nuestros dedos, que permiten disfrutar de estos platillos de manera práctica y original, ideales para caterings y eventos.

The term "finger food" refers to food that can be eaten with the hands, without the need for cutlery. These dishes are usually small, easy to eat and designed to be savoured in one or two bites.

Following this concept, Comas has created a collection of small-sized cutlery, like an extension of our fingers, which allows us to enjoy these dishes in a practical and original way.



Finger Food

INOX Nickel Free 18% / 2mm / Vintage



PACKAGING
CUSTOM BOX

MINI CUBIERTOS PARA EXPERIENCIAS DE GRAN SABOR BIG TASTE EXPERIENCES MINI CUTLERY



Cubertería de diseño propio creada para comidas de servicio rápido.
Own design cutlery created for fast-service meals.

INOX
STAINLESS
STEEL
430

- A **8784** CUCHILLO LUNCH
cake knife, couteau gâteau, coltello dolce, kuchenmesser
- B **8786** CUCHARA CAFÉ
tea spoon, cuillère café, cucchiaio caffè, kaffeelöffel
- C **8785** TENEDOR LUNCH
cake fork, fourchette gâteau, forchetta dolce, kuchengabel
- D **8787** PINCHO TAPAS
cocktail stick, stick à cocktail, spiedo, spieb
- 8795** PACK 4 PCS
pack 4 pieces, pack 4 pièces, pack 4 pz., 4 pack

UE	MOQ	✂ mm	✂ mm
0/12/120/2520/15120	24	140	6
0/12/120/2520/15120	24	130	2
0/12/120/2520/15120	24	130	2
0/12/120/2520/15120	24	137	2
1/24/96/576/2880	24		

INOX
STAINLESS
STEEL
430



1001 Black

INOX Nickel Free 18% / 1mm / PVD

- A **1746** TENEDOR MINI LUNCH
mini cake fork, fourchette minigâteau, forchetta mini dolce, kuchengabel klein
- B **1747** CUCHARA MOKA
coffee/moka spoon, cuillère moka, cucchiaio moka, mokkalöffel

UE	MOQ	✂ mm	✂ mm
0/12/600/25200/75600	120	110	1
0/12/600/25200/75600	120	110	1



LES ESSENCES
 CATERING LINE



lab
 SERIES



CALIU

Comas apuesta por crear un sistema eficiente de servicio y presentación tanto en sala, catering o buffet.

Los diseños modulares y complementarios entre sí de las colecciones Les Essences, Lab y Caliu elevan la experiencia del cliente mediante presentaciones más atractivas pudiendo combinar colores, materiales y composición, creando una coherencia visual.

Al personal de hostelería le permite mejorar la eficiencia operativa lo que se traduce en una reducción de tiempos de preparación, desmontaje y almacenaje.

Comas is committed to creating an efficient system of service and presentation in the dining room, catering or buffet.

The modular and complementary designs of the Les Essences, Lab and Caliu collections enhance the customer experience through more attractive presentations by combining colours, materials and composition, creating visual coherence.

It allows catering staff to improve operational efficiency, which translates into reduced preparation, dismantling and storage times.

BRASA

GRILL



466 CALIU

- 466 BBQ
- 468 ACCESORIOS
- 470 PARRILLAS
- 472 ROBATA YAKI
- 474 KITS

476 BRASA / EMBER

- 476 IGNIS
- 478 KASAI
- 480 LLAUNES
- 482 PLATO PIEDRA
- 484 PLATO HIERRO FUNDIDO
- 486 ACCESORIOS
- 488 CARBÓN



Descubre
el catálogo
de brasa.

BARBACOA CALIU

Las barbacoas de sobremesa Caliu destacan por su diseño único y minimalista pero también por su versatilidad para trabajar múltiples técnicas y cocciones. El embellecedor reversible te permite elegir dos alturas diferentes con las que cocinar.

CALIU BARBACUE

Caliu tabletop barbecues stand out for their unique and minimalist design and their versatility to multiple cooking methods and techniques. With the convertible outer house, you may choose between two different cooking heights.

Sin ensamblajes ni partes móviles, producida con pocas piezas para obtener un resultado robusto y duradero.

No assemblies or moving parts, produced with few parts for a robust and durable result.

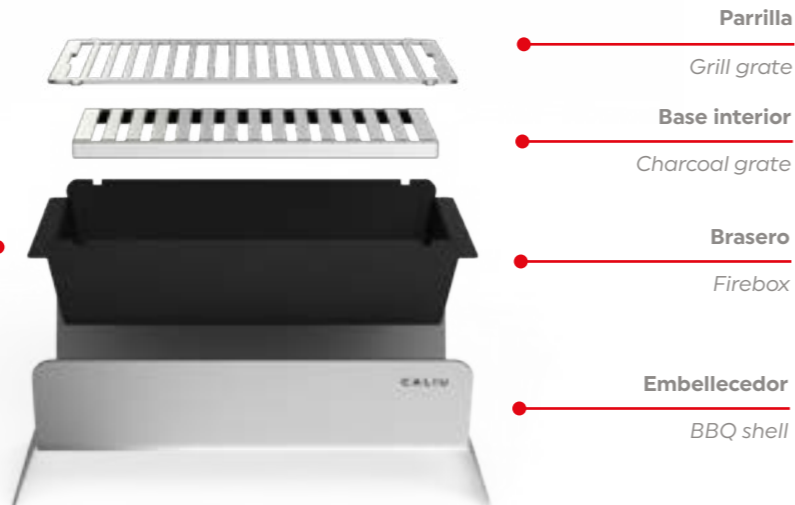

Versátil, modular, ligera, confeccionada íntegramente en acero inoxidable y provista de todos los accesorios necesarios, adaptándose sin problemas a cualquier entorno.

Versatile, modular, lightweight, crafted entirely from stainless steel, and equipped with all necessary accessories, it seamlessly adapts to any environment.



Discover Caliu's World



PARRILLA



ESTRUCTURA

Caliu
BBQ / BBQ



BBQ Caliu Horeca

REF.	W(mm)	L(mm)	H(mm)	€	UE / MOQ
8500	299	452	160		1-0-1-6-18 / 1



BBQ Caliu Catering

REF.	W(mm)	L(mm)	H(mm)	€	UE / MOQ
8684	299,5	859	160		1-0-1-6-18 / 1



CALIU ACCESORIOS

Mejora tus habilidades a la brasa con los accesorios adecuados, desde dispositivos experimentales hasta elementos esenciales clásicos. Con las herramientas adecuadas, como la tapa que transforma tu barbacoa en un horno, el mango multitarea, la chimenea para encender el carbón rápidamente...

INOX STAINLESS STEEL 430

Tapa BBQ
Bbq lid
Couvercle du bbq
Coperchio del bbq
Grilldeckel



Efecto horno, potencia los aromas.
Oven effect, enhances the aromas.



REF.	W(mm)	L(mm)	H(mm)	€	UE / MOQ
9969	260	366,2	140		1-0-4-24-72 / 1

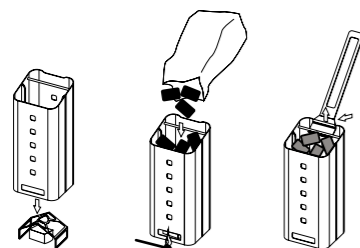

La chimenea Caliu es la mejor herramienta para encender el carbón de forma rápida, limpia y segura, en 20 minutos estará listo para empezar a cocinar.

In just 20 minutes, you'll be able to start cooking thanks to the Caliu Chimney's ability to ignite coal fast, cleanly, and safely.

INOX STAINLESS STEEL 430

Chimenea BBQ
Chimney BBQ
Cheminée BBQ
Grigliato camino BBQ
BBQ kamin



REF.	W(mm)	L(mm)	H(mm)	€	UE / MOQ
8686	80	125	300		1-0-4-68-128 / 1

SILICONE



Cubrebandeja silicona GN 1/1
Silicon tray cover GN 1/1
Couvercle plateau silicone GN 1/1
Coperchio vassoio in silicone GN 1/1
Tablett mit silikonbeschichtung GN 1/1



REF.	W(mm)	L(mm)	€	UE / MOQ
10785	325	530		1-4-64-0-0 / 4

INOX STAINLESS STEEL 430

Pinza BBQ
Bbq tong
Pince bbq
Molla bbq
Zange bbq



REF.	W(mm)	L(mm)	€	UE / MOQ
8687	55	260		1-0-48-5765-1728 / 1



INOX STAINLESS STEEL 304

PARRILLA ESTRUCTURA

INOX STAINLESS STEEL 430



Plato brasa
Bbq plate
Assiette bbq
Piatto bbq
Grillplate

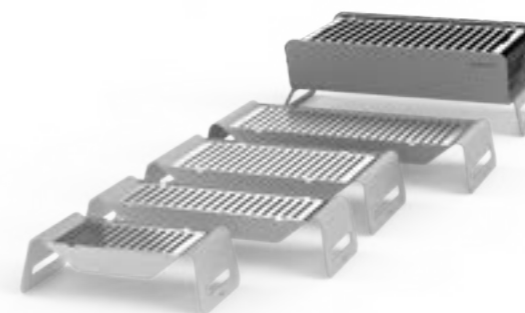

REF.	W(mm)	L(mm)	H(mm)	€	UE / MOQ
S 8181	137,5	253	82		1-0-4-56-224 / 1
M 8685	137,5	354	82		1-0-4-56-168 / 1
L 11484	212,5	354	82		1-0-4-0-0 / 1
XL 11485	442	212,5	82		1-0-4-0-0 / 1

S
Aperitivo / Side

M
Degustación / Tasting

L
Principal / Main

XL
Compartir / Sharing



Recambio parrilla
Inox grill bbq spare part
Pièce de rechange inox gril bbq
Ricambio inox griglia bbq
Inox grill grillplate ersatzteil

REF.	W(mm)	L(mm)	H(mm)	€	UE / MOQ
S 11489	121	171			1-0-0-0-0 / 1
M 11490	121	272			1-0-0-0-0 / 1
L 11491	196	272			1-0-0-0-0 / 1
XL 11492	198	360			1-0-0-0-0 / 1

Base interior plato brasa
Interior base for grilled plate
Base intérieure pour plaque grillée
Base interna per piastra grigliata
Innensockel für grillplatte

REF.	W(mm)	L(mm)	H(mm)	€	UE / MOQ
S 11578	95	85	10		1-0-0-0-0 / 1
M 11579	95	186	10		1-0-0-0-0 / 1
L 11580	170	186	10		1-0-0-0-0 / 1
XL 11581	170	274	10		1-0-0-0-0 / 1



PARRILLAS CALIU

Conviértete en un experto de la brasa con las parrillas Caliu, gracias a sus materiales de alta calidad. Estas parrillas proporcionan un rendimiento excepcional y una gran durabilidad, lo que las hace ideales para conseguir el sellado perfecto o añadir un sabor extra a tus alimentos.

CALIU GRATES

Caliu's grates will turn you into a grill master, delivering unbeatable flavor through various techniques and high-quality materials. These grates provide exceptional performance and durability, ideal for achieving the perfect sear or adding extra flavor to your food.

Parrilla de marcaje. Parrilla de hierro fundido. Ideal para lograr un marcado bien definido.
Marking Grate. Cast Iron Grate. Ideal for achieving sear marks.

Parrilla YAKI. Malla inoxidable. Perfecta para cocinar una amplia gama de alimentos.
YAKI Grate. Stainless steel mesh. Perfect for grilling a wide range of foods.

Parrilla CALIU (estándar). Alta calidad, resistente al óxido y a la corrosión, fácil de limpiar y mantener.
CALIU Grate (standard). High quality, rust and corrosion-resistant, easy to clean and maintain.

Plancha CALIU. Una superficie de cocción versátil, eficiente y duradera.
CALIU Griddle. A versatile, efficient and durable cooking surface.

* Todas las parrillas son compatibles con el mango CALIU. / All grates are compatible with the CALIU handle.



Discover Caliu's World

INOX STAINLESS STEEL 304

Recambio parrilla inox BBQ Caliu
Inox grill caliu bbq
Pièce de rechange inox grill caliu bbq
Ricambio inox griglia caliu bbq
Inox caliu grill grillplate ersatzteil

REF.	W(mm)	L(mm)	H(mm)	€	UE / MOQ
11495	268	363	3		1-0-0-0-0/1

CAST IRON

Parrilla hierro fundido
Cast iron grill
Fonte grill
Chisa griglia
Gusseisen grill

REF.	W(mm)	L(mm)	H(mm)	€	UE / MOQ
11487	268	363	10		1-0-0-0-0/1

CHROME **FOOD CONTACT**

Plancha inox cromada
Chrome grill
Chromée grill
Cromata griglia
Chromeplatte

REF.	W(mm)	L(mm)	H(mm)	€	UE / MOQ
11486	267	373	5		1-0-0-0-0/1

INOX STAINLESS STEEL 304

Parrilla varilla inox
Net inox grill
inox filet grill
inox griglia netta
inox netz grill

REF.	W(mm)	L(mm)	H(mm)	€	UE / MOQ
11488	267	373	3		1-0-0-0-0/1

INOX STAINLESS STEEL 304

Pack 6 brocheta inox
Inox skewer
Inox brochette
Inox spiedo
Inox spieß

PACK 6

REF.	L(mm)	€	UE / MOQ
11493	35		1-0-0-0-0/1
11494	20		1-0-0-0-0/1

INOX STAINLESS STEEL 430

Recambio rejilla base interior bbq caliu
Inner base caliu horeca bbq
base intérieure caliu horeca bbq
base interna caliu horeca bbq
innere basis caliu horeca bbq

REF.	W(mm)	L(mm)	H(mm)	€	UE / MOQ
5126	178	335	1,5		1-0-0-0-0/1

El accesorio perfecto para los chefs profesionales que permite convertir la barbacoa en una estación de brasa para catering, con la capacidad de trabajar por capas en distintas alturas y maximizar la producción.

The perfect accessory for professional chefs to convert the barbecue into a catering grill station, with the ability to work in layers at different heights and maximise production. It offers a more versatile and efficient cooking experience.



Discover
Caliu's
World



Caliu
ROBATAYAKI

Combina con recipientes 1/3, 1/6 y 1/9 GN.

Combines with 1/3, 1/6 and 1/9 GN.

Combina con Pinchos Touché, ver p. 495

Combines Touché Skewer, see p. 495

Combina con Llaunes COMAS, ver p. 510

Combines with Llaunes COMAS, see p. 510

Combina con todas las parrillas CALIU, ver p. 495

Combines with all CALIU grates, see p. 495

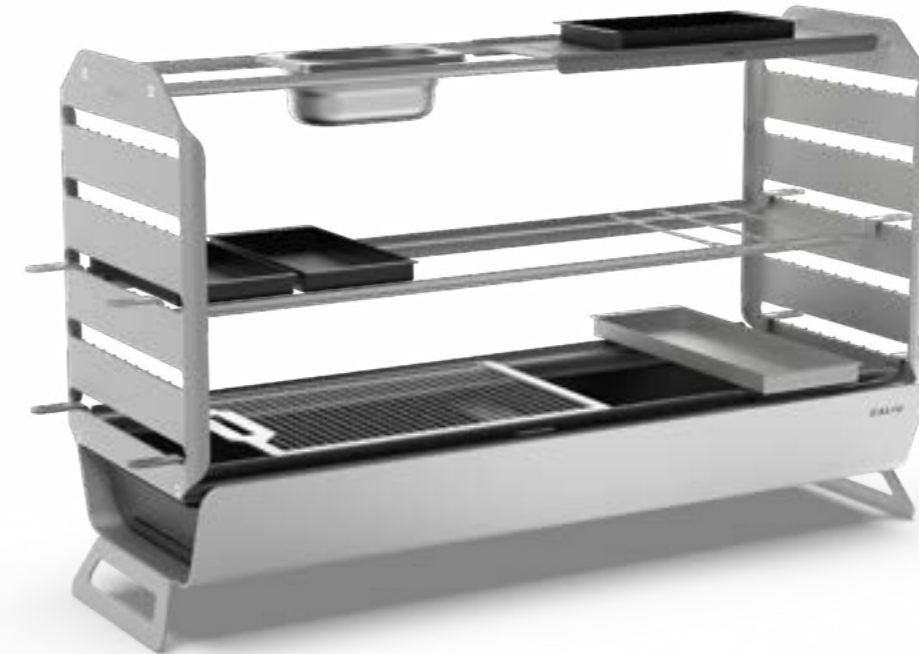

NO INCLUYE: BBQ Caliu catering
NOT INCLUDED: BBQ Caliu catering



Robata grill YAKI

REF.	W(mm)	L(mm)	H(mm)	KG	€	UE / MOQ
10957	295	812	430	14		1-0-0-0-0 / 1

Con el Yaki, tendrás la libertad de cocinar de diversas maneras gracias a su diseño innovador y versátil.

Se compone de barras móviles que se colocan en las ranuras laterales de la barbacoa, lo que permite ajustar fácilmente la altura de la parrilla. Son ideales para Cubetes GN de 1/4 y 1/6, lo que te permite mantener salsas o guarniciones calientes y emplatar directamente.

Recambio barras móviles Robata Yaki

Spare Robata Yaki mobile bars
Pièce de rechange barre amovible
Ricambio barra estraibile
Abnehmbares ersatzteil für die stange

REF.	PCS	€	UE / MOQ
11066	2		1-0-0-0-0 / 1

Recambio bandeja superior Robata Yaki

Replacement top tray Robata Yaki
Pièce de rechange étagère
Ricambio mensola
Regal ersatzteil

REF.	PCS	€	UE / MOQ
11482	1		1-0-0-0-0 / 1

With the Yaki, you have the freedom to cook in a variety of ways thanks to its innovative and versatile design.

It consists of movable bars that are placed in the side slots of the barbecue, allowing you to easily adjust the height of the grill. They are ideal for 1/4 and 1/6 GN tubs, allowing you to keep sauces or side dishes hot and plate them directly.



PACKAGING
CUSTOM BOX

Caliu es la marca de conceptos gastronómicos creada hace 10 años por bahígüell, una agencia de diseño de producto de Girona. 'Creemos que los detalles importan, por eso cuidamos cada fase del diseño y funcionalidad, desde el primer boceto de la fase conceptual hasta el acabado final del producto'. -bahígüell.

The gastronomic concepts brand Caliu was created 10 years ago by the product design agency bahígüell, based in Girona. 'We believe that details matter, that's why we take care of every phase of design and functionality, from the first sketch in the conceptual phase to the final product finish'. -bahígüell.



KIT CALIU 1. ESSENTIAL

BBQ Caliu + Pinza + Chimenea
BBQ Caliu + Tong + Chimney

REF.	€	UE / MOQ
8182		1-0-1-0-0 / 1



KIT CALIU 2. PREMIUM

BBQ Caliu + Tapa + Pinza + Chimenea
BBQ Caliu + Lid + Tong + Chimney

REF.	€	UE / MOQ
8183		1-0-1-0-0 / 1

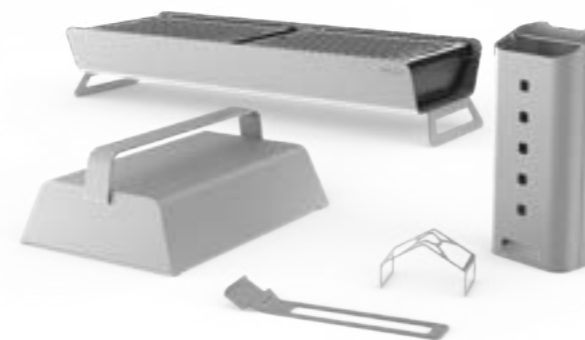

KIT CALIU 3. CATERING PREMIUM

BBQ Caliu Catering + Tapa + Pinza + Chimenea
BBQ Caliu Catering + Lid + Tong + Chimney

REF.	€	UE / MOQ
11626		1-0-1-0-0 / 1



KIT CALIU 4. ROBATA YAKI

BBQ Caliu Catering + Robata Yaki + Pinza + Chimenea
BBQ Caliu Catering + Robata Yaki + Tong + Chimney

REF.	€	UE / MOQ
11627		1-0-1-0-0 / 1



PACKAGING
CUSTOM BOX

NEW



APTA PARA
LEÑA Y CARBÓN

Ignis

Bbq hierro fundido Cast iron bbq

La grasa no se acumula en la plancha, lo que garantiza un punto de cocción perfecto.

Fat does not accumulate on the griddle, which guarantees a perfect cooking point.

Diseño de parrilla circular, fundida en una sola pieza, con mucha superficie operativa.

Circular grill design, cast in one piece, with a large operating surface.

Estructura de hierro fundido de alta calidad.

High quality cast iron structure.

Parrilla con salidas de aire ajustables que permiten el control preciso del calor para adaptarse a las diferentes necesidades del cocinado.

Grill with adjustable air vents that allow precise heat control to suit different cooking needs.

Recubierto con aceite vegetal, le proporciona antiadherencia a la superficie.

Coated with vegetable oil, it provides non-stick surface.

Excelente retención y distribución del calor.

Excellent heat retention and heat distribution.

Espacio para almacenar leña o carbón.

Space for storing firewood or charcoal.

4 ruedas pivotantes, 2 de ellas con freno.

4 swivel castors, 2 of them with brakes.

**Disco de HIERRO FUNDIDO
CAST IRON Disc**

720 mm

900 mm



INCLUYE ARO ELEVADOR
ELEVATOR RING INCLUDED



INCLUYE PRENSA PARA CARNE
MEAT PRESS INCLUDED

Bbq Disco Hierro Colado C/Cajon Cenizas
Bbq Cast Iron Disc With Ash Draw
Bbq Disque En Fonte Avec Tiroir À Cendres
Bbq Disco In Ghisa/ Cassetto Ceneri
Bbq Drehscheibe Gusseisen M. Aschekiste

REF.	PESO(kg)	€	UE / MOQ
11978	10		0-0-1-0-0 / 1

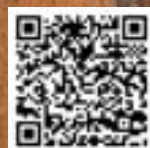

Conoce
Ignis.

Una barbacoa de ladrillo refractario es una excelente opción para quienes deseen una estructura duradera y resistente para cocinar a la parrilla al aire libre. La capacidad aislante del material refractario permite una mayor eficiencia calorífica.

A refractory brick barbecue is an excellent choice for those who want a durable and resistant structure for outdoor grilling. The insulating capacity of the refractory material allows for greater heat efficiency.

MATERIAL DURADERO: Resistente al calor y a las altas temperaturas. Soporta cocciones sin agrietarse ni deformarse con facilidad.



DURABLE MATERIAL: Resistant to heat and high temperatures. Withstands cooking without cracking or deforming easily.

BUENA RETENCIÓN DEL CALOR: El ladrillo refractario tiene la capacidad de retener el calor de manera eficiente, lo que te permite cocinar de forma uniforme y mantener la temperatura deseada durante más tiempo.



GOOD HEAT RETENTION: The refractory brick has the ability to retain heat efficiently, allowing you to cook evenly and maintain the desired temperature for longer.

OPCIÓN SEGURA: El ladrillo refractario no emite sustancias tóxicas ni partículas dañinas cuando se calienta, lo que lo convierte en una opción segura para cocinar alimentos.



SAFE CHOICE: The refractory brick doesn't emit toxic substances or harmful particles when heated, making it a safe choice for cooking food.

Parrilla de cocción.
Cooking mesh.

Asas de acero inoxidable.
Stainless steel handles.

Vermiculita.
Vermiculite.

Ranuras de ventilación deslizantes.
Sliding air vents.



Ladrillo refractario.
Fire brick.

Acero inoxidable cepillado.
Brushed stainless steel.



Conoce Kasai.

Kasai
BBQ

INOX STAINLESS STEEL
430

Barbacoa KASAI
KASAI BBQ



REF.	W(mm)	L(mm)	H(mm)	MODELO	€	UE / MOQ
11121	230	310	165	NANO		1-0-1-4-16 / 1
11122	265	405	210	SMALL		1-0-1-4-16 / 1
11123	355	465	210	MEDIUM		1-0-1-4-16 / 1
11124	260	700	210	LARGE		1-0-1-4-16 / 1

INOX STAINLESS STEEL
430

Plancha BBQ
BBQ grill



REF.	W(mm)	L(mm)	MODELO	€	UE / MOQ
11125	350	240	NANO		1-0-1-4-16 / 1
11126	400	240	SMALL		1-0-1-4-16 / 1
11127	470	300	MEDIUM		1-0-1-4-16 / 1

VERMICULITE

Tapete térmico
Thermic mat

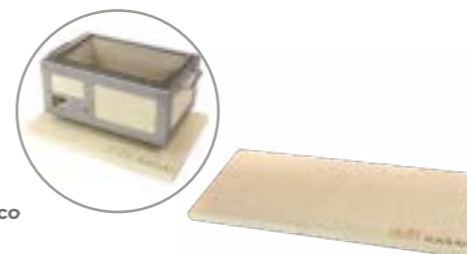

REF.	W(mm)	L(mm)	MODELO	€	UE / MOQ
11135	300	400	NANO		1-0-1-4-16 / 1
11136	350	500	SMALL		1-0-1-4-16 / 1
11137	400	600	MEDIUM		1-0-1-4-16 / 1
11138	350	800	LARGE		1-0-1-4-16 / 1

INOX STAINLESS STEEL
430

Malla repuesto BBQ
BBQ spare mesh



REF.	W(mm)	L(mm)	MODELO	€	UE / MOQ
11131	350	240	NANO		1-0-1-4-16 / 1
11132	400	240	SMALL		1-0-1-4-16 / 1
11133	470	300	MEDIUM		1-0-1-4-16 / 1
11134	700	260	LARGE		1-0-1-4-16 / 1

INOX STAINLESS STEEL
430

50:50 plancha BBQ
50:50 BBQ grill

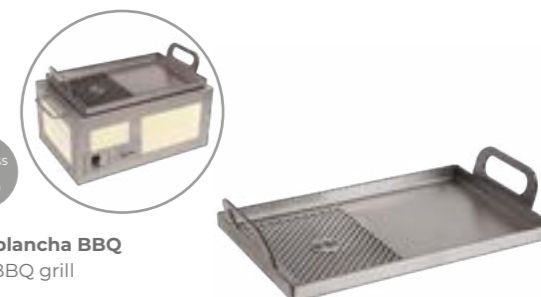

REF.	W(mm)	L(mm)	MODELO	€	UE / MOQ
11128	350	250	NANO		1-0-1-4-16 / 1
11129	400	360	SMALL		1-0-1-4-16 / 1
11130	470	354	MEDIUM		1-0-1-4-16 / 1

INOX STAINLESS STEEL
430

Soporte 6 brochetas
6 skewer support



REF.	W(mm)	L(mm)	MODELO	€	UE / MOQ
11139	310	230	NANO		1-0-1-4-16 / 1
11140	370	240	SMALL		1-0-1-4-16 / 1
11141	430	320	MEDIUM		1-0-1-4-16 / 1
11142	680	250	LARGE		1-0-1-4-16 / 1

6 BROCHETAS INCLUIDAS
6 SKEWERS INCLUDED

NEW



* Se vende por separado
Sold separately



Llauna inox
St/st llauna
Llauna acier
Llauna acciaio
Llauna stahl



REF.	RACIONES	W(mm)	L(mm)	H(mm)	€	UE / MOQ
10689	TAPA	115	226	20		1-0-24-0-0 / 1
10690	1	115	331	20		1-0-24-0-0 / 1
10691	2	230	331	20		1-0-12-0-0 / 1

* Se vende por separado
Sold separately



Llauna CARBON STEEL
St/st llauna
Llauna acier
Llauna acciaio
Llauna stahl



REF.	RACIONES	W(mm)	L(mm)	H(mm)	€	UE / MOQ
10692	TAPA	115	226	20		1-0-24-0-0 / 1
10693	1	115	331	20		1-0-24-0-0 / 1
10694	2	230	331	20		1-0-12-0-0 / 1



Base corcho
Cork base
Support en liège
Table di sughero
Korkbasis



REF.	W(mm)	L(mm)	H(mm)	€	UE / MOQ
10698	129	238	20		1-0-24-0-0 / 1
10699	129	343	20		1-0-24-0-0 / 1
10700	244	343	20		1-0-24-0-0 / 1

Llauna de acero inoxidable de alta calidad, apta para el uso en horno y barbacoas. Soporta temperaturas de hasta 400°C

High-quality stainless steel plate, suitable for use in ovens and barbecues. Withstands temperatures up to 400°C



Llauna fabricada en acero de carbono que le proporciona una gran dureza y resistencia. Es apto para horno, inducción y barbacoa y soporta temperaturas de hasta 220°C

The carbon steel plate is made of carbon steel, which makes it very hard and resistant. It is suitable for oven, induction and barbecue and withstands temperatures up to 220°C.



Corcho 100 % natural reciclable y reutilizable. Resistente a altas temperaturas y a la humedad. No es apto para lavavajillas.

100% natural cork, recyclable and reusable. It is resistant to high temperatures and humidity. It is not dishwasher safe.



PACKAGING
CUSTOM BOX



PLATO PIEDRA / STONE PLATE

Esta colección combina la elegancia de la cerámica con la fuerza del basalto volcánico, ofreciendo 3 formatos adaptables para presentaciones individuales o para compartir. Pensada para cocinar y mantener los alimentos calientes en mesa, es una solución práctica y visualmente atractiva.

La piedra de 10mm es perfecta para la presentación de alimentos a una temperatura óptima, mientras que la de 20mm funciona como plancha para verduras, carnes y marisco.

El diseño modular incluye una base elevada que aísla el calor y bordes inclinados para recoger grasas y líquidos con eficacia.

This collection combines the elegance of ceramic with the strength of volcanic basalt, offering three adaptable formats for individual presentations or for sharing. Designed for cooking and keeping food warm at the table, it is a practical and visually appealing solution.

The 10mm stone is perfect for presenting food at an optimal temperature, while the 20mm stone functions as a griddle for vegetables, meat or seafood.

The modular design includes a raised base to insulate heat and sloped edges to collect fats and liquids effectively. You can use one, two or no stones, as the plate alone is also ideal for presentation.

Piedra de 20mm de espesor que mantiene perfectamente el calor para presentación en mesa y acabado de punto de cocción.

20mm thickness stone maintains perfectly the heat for table presentation and finishing cooking point.



Canales para recogida de líquidos y potenciar la circulación de aire.

Liquid collecting channels enhances air circulation.

Punto de sujeción y elevación para aislamiento térmico.

Subjection point and elevation for thermal insulation.

Sus bordes inclinados facilitan la recogida de grasas y líquidos.

Sloping edges ease the fat and liquid collection.

PIEDRA BASALTO / BASALT STONE:

- De origen volcánico
- Ideal para acabar o presentar elaboraciones en mesa.
- Calentar en horno a un máximo de 260°C
- Volcanic origin
- Ideal for finishing or presenting dishes at the table
- Heat in the oven to a maximum of 260°C.

3 FORMATOS / 3 FORMATS:



Piedra Basalto
Basalt Stone
Pierre De Basalte
Pietra In Basalto
Basaltstein



240 x 240 mm
H: 20 mm



Ø 320 mm
H: 20 mm



328 x 228 mm
H: 10 mm

* Compatible sólo con base de corcho. REF.: 10700

REF.	W(mm)	L(mm)	H(mm)	€	UE / MOQ
11825	240	240	20		1-0-39-0-0 / 1
11826	320	320	20		1-0-25-0-0 / 1
11768	328	228	10		1-0-50-0-0 / 1



PACKAGING CUSTOM BOX

PLATO CERÁMICA (FALME CERAMIC):

- Cerámica muy resistente a los cambios bruscos de temperatura.
- Rápida transferencia de calor.
- Conserva el calor durante horas.
- En caso de calentar se recomienda colocar sobre una base para evitar quemaduras.
- Se recomienda lavar a mano cuando vuelva a estar a temperatura ambiente
- Ceramic highly resistant to sudden temperature changes
- Rapid heat transfer
- Retains heat for hours
- In case of heating it is recommended to place on a base to avoid burns
- It is recommended to wash by hand when it returns to room temperature.

3 FORMATOS / 3 FORMATS:



Plato Ceramica
Ceramic Dish
Assiette Porcelaine
Piatto In Porcellana
Porzellanteller



SIMPLE
240 x 240 mm
H: 20 mm



DOBLE
Ø 320 mm
H: 20 mm



REDONDO
328 x 228 mm
H: 10 mm

REF.	W(mm)	L(mm)	H(mm)	€	UE / MOQ
11820	240	240	20		0-1-12-0-0 / 1
11821	240	480	20		0-1-6-0-0 / 1
11822	320	320	20		0-1-8-0-0 / 1



PACKAGING CUSTOM BOX



Plato de hierro fundido adecuado tanto para mantener como para terminar la cocción en mesa. El plato viene acompañado de una base de madera para poder servir en mesa.

Cast iron plate suitable both for holding and for finishing cooking at the table. The plate comes with a wooden base for serving at the table.



APTO PARA BRASA
SUITABLE FOR BBQ



APTO PARA HORN
SUITABLE FOR OVEN



350°C



HIDRATAR CON ACEITE
HYDRATE WITH OIL



PLATO HIERRO FUNDIDO
CAST IRON PLATE

Aguanta hasta 350C°. Después de usar, dejar enfriar y lavar a mano con agua y jabón. Secar con un paño suave y poner una capa de aceite para mejor conservación.

It can withstand up to 350C°. After use, leave to cool and wash by hand with soap and water. Dry with a soft cloth and coat with oil for better preservation.



BASE DE ACACIA
ACACIA WOOD BASE

Base de madera acacia que sirve como soporte del plato de hierro fundido. Lavar con un paño suave.

Acacia wood base that serves as a support for the cast iron plate. Wash with a soft cloth.



Plato hierro fundido + Base madera acacia
Cast iron plate + Acacia wood base
Plaque en fonte + socle en bois d'acacia
Piastra in ghisa + base in legno d'acacia
Platte aus Gusseisen + Unterteller eichenholz



REF.	Ø (mm)	€	UE / MOQ
11973	320		1-0-4-0-0 / 1
12007	350		1-0-3-0-0 / 1



Fabricados en cuero de alta calidad y forrados en el interior.

Manufactured in high-quality leather and lined.



Sus puños largos proporcionan una protección extra para los antebrazos.

The long cuffs provide extra protection for your forearms.

Guantes piel para horno

Leather oven gloves
Gants de four en cuir
Guanti da forno in pelle
Lederhandschuhe

* Estos guantes cumplen con la normativa Europea 2016/425 y EN 407:2004 nivel 3 relativo a los equipos de protección individual (EPI).

These gloves are compliant with EU Regulation 2016/425 concerning personal protective equipment (PPE) and meet EN 407:2004 Level 3, for work gloves.

REF.	L(mm)	€	UE / MOQ
10715	460		1-0-50-100-400 / 1

INOX STAINLESS STEEL 304

Escurre fritos y carnes

Fry colander
Passoire à frites
Cesta per friggere
Frittensieb



Esprai aceite

Oil spray
Pulvérisateur d'huile
Spray d'olio
Ölspray



REF.	L(mm)	€	UE / MOQ
9997	100		1-0-24-288-1440 / 1

REF.	W(mm)	L(mm)	€	UE / MOQ
8381	290	400		1-0-6-24-24 / 1
8382	390	500		1-0-4-12-24 / 1
8383	390	600		1-0-3-9-27 / 1

Base de esparto

Placemat
Sets de table
Tovaglietta
Platzmatten



REF.	Ø(mm)	€	UE / MOQ
10716	380		1-4-48-144-576 / 1

NEW

Cepillo limpia barbacoa

Placemat
Sets de table
Tovaglietta
Platzmatten



REF.	Ø(mm)	€	UE / MOQ
9995	380		1-0-12-0-0 / 1

Punta plana para girar o coger alimentos con precisión.

Flat tip for precise turning or picking up food.



Pinza BBQ

BBQ tong
Pince BBQ
Pinze BBQ
BBQ zange

REF.	L(mm)	W(mm)	H(mm)	€	UE / MOQ
10682	405	100	27		1-0-24-0-0 / 1

Gancho central para facilitar el manejo de las parrillas.

Central hook for easy handling of the grills.

Mango recubierto de PVC para mayor comodidad.

PVC coated handle for comfort.



Pinza BBQ plana

BBQ tong flat
Pince BBQ plain
Pinze BBQ piano
BBQ zange boden

REF.	L(mm)	W(mm)	H(mm)	€	UE / MOQ
10683	405	100	55		1-0-24-0-0 / 1

INOX STAINLESS STEEL 430

Pack 6 pinchos inox

Pack 6 ss skewers inox
Pack 6 piques acier
Pack 6 spiedo acciaio
Pack 6 spießchen stahl



REF.	L(mm)	€	UE / MOQ
9993	250		1-24-96-0-0 / 1
9994	300		1-24-96-0-0 / 1

INOX STAINLESS STEEL 304

Pack 6 brocheta inox

Inox skewer
Inox brochette
Inox spiedo
Inox spieß



REF.	L(mm)	€	UE / MOQ
11493	35		1-0-0-0-0 / 1
11494	20		1-0-0-0-0 / 1

PACK 6

Besuguera

Fish grill
Grill à poisson
Griglie per pesce
Fischgrillkorb aus edelstahl



REF.	SIZE	W(mm)	H(mm)	€	UE / MOQ
10679	S	165	80		1-0-6-24-144 / 1
10680	M	200	100		1-0-6-18-108 / 1
10681	L	290	120		1-0-4-8-48 / 1



Discover
Caliu's
World

Carbón

Carbón de COCO / COCONUT Charcoal



Hecho con cáscaras de coco naturales de plantaciones certificadas y presentado en forma de briquetas cúbicas. Perfecto por su poder calorífico estable, de larga duración, sin llama, sin chispas y poco humo.

It is supplied as cubic briquettes and is created from natural coconut shells from verified plantations. Perfect for its stable, long-lasting, flame-free, non-sparking and low-smoke heating power.

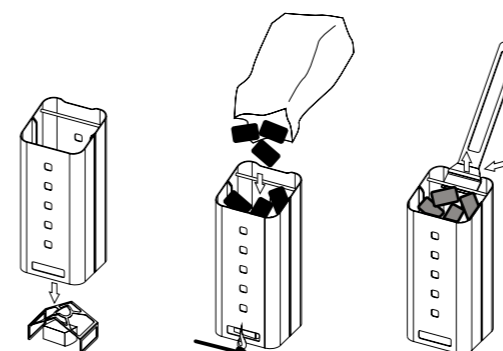

La chimenea Caliu es la mejor herramienta para encender el carbón de forma rápida, limpia y segura, en 20 minutos estará listo para empezar a cocinar.

In just 20 minutes, you'll be able to start cooking thanks to the Caliu Chimney's ability to ignite coal fast, cleanly, and safely.

INOX
STAINLESS
STEEL
430

Chimenea BBQ
Chimney BBQ
Cheminée BBQ
Grigliato camino BBQ
BBQ kamin



REF.	W(mm)	L(mm)	H(mm)	€	UE / MOQ
8686	80	125	300		1-0-4-64-128 / 1



Garantiza la sostenibilidad de este producto.

It guarantees the sustainability of this product.



Tiempo de combustión: 15 minutos

Burning time: 15 minutes



Pastillas naturales y ecológicas, procedentes de residuos naturales.

Natural and environmentally friendly tablets from natural waste.



No producen olores y no son tóxicas.

They are odourless and non-toxic.



Lanas de encendido

Firelighters
Laine De Bois Pour Allumage
Lana Di Legno Accendi
Bbq Anzündler



X32

REF.	PESO	€	UE / MOQ
11974	400gr. (aprox.)		1-0-0-0-0 / 1



Briquetas de carbón elaboradas **exclusivamente a partir de cáscara de coco carbonizada y compactada**.

Por su composición y su densidad, las briquetas tienen un **poder calorífico muy superior** a la de cualquier otra briqueta o carbón, y mantienen la combustión a plena temperatura durante casi tres horas.

No levanta polvo ni cenizas durante la combustión ni una vez finalizada, por lo que no es imprescindible la limpieza inmediata.

Charcoal briquettes are made **exclusively from carbonised and compacted coconut shells**.

Due to their composition and density, the briquettes have a **calorific value far superior** to that of any other briquette or charcoal, and maintain combustion at full temperature for almost three hours.

It **does not raise dust or ashes** during combustion or once it is finished, so it is not essential to clean it immediately.

CASCARA DE COCO CARBONIZADA Y COMPACTADA

CARBONISED AND COMPACTED COCONUT SHELLS.



Briqueta de COCO
COCONUT Briquette
Briquette de COCO
Bricchetto di COCCO
Kokosnussbrikett

REF.	PESO(kg)	€	UE / MOQ
10803	5KG		1-0-0-24-72 / 1
10804	10KG		1-0-1-8-40 / 1



SERRÍN DE COCO COMPACTADO

COMPACTED COCONUT SHELLS



Carbón de coco sawdust
Coconut charcoal sawdust
Charbon de coco sawdust
Carbone di cocco sawdust
Kokosnusskohle sawdust

REF.	PESO(kg)	€	UE / MOQ
11641	10		1-0-1-0-0 / 1



+2,5 HORAS DE COMBUSTIÓN Y MÁXIMA EFICIENCIA CALORÍFICA.

+2,5 HOURS OF COMBUSTION AND MAXIMUM HEAT EFFICIENCY.

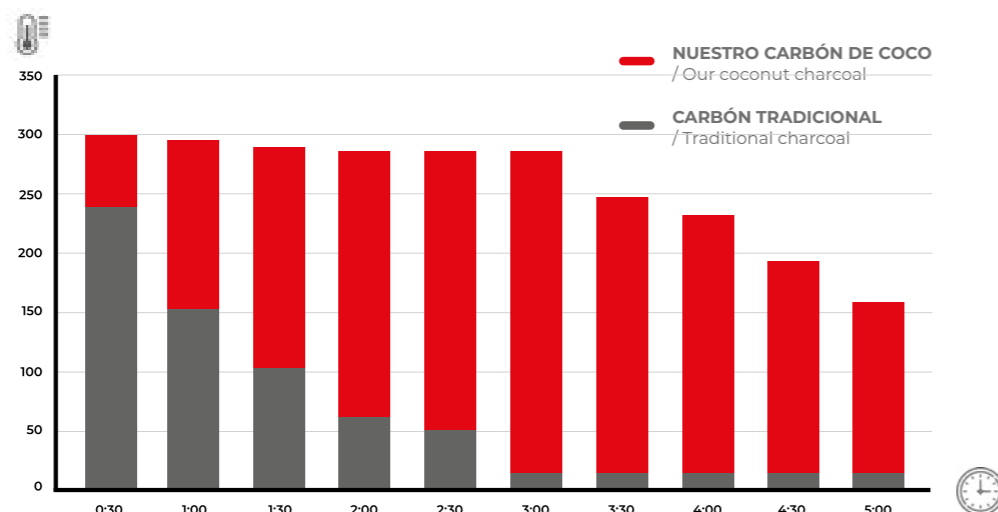

VENTAJAS CARBÓN DE COCO SAWDUST / ADVANTAGES OF SAWDUST COCONUT CHARCOAL



SIN LLAMA
Más control sobre la cocción de alimentos.

FLAMELESS
More control over the cooking of food.



SIN CHISPAS
Apto para uso en interiores.

SPARKLESS
Suitable for indoor use.



SIN HUMO
No altera el sabor de los alimentos.

NO SMOKE
It does not alter the taste of food.

- Limpio / Clean
- Eficiente / Efficient
- Económico / Economic
- Útil / Useful
- Ecológico / Ecologic
- Seguro / Safe
- Cómodo / Convenient
- Sin gases sulfúricos tóxicos / No toxic sulphuric fumes

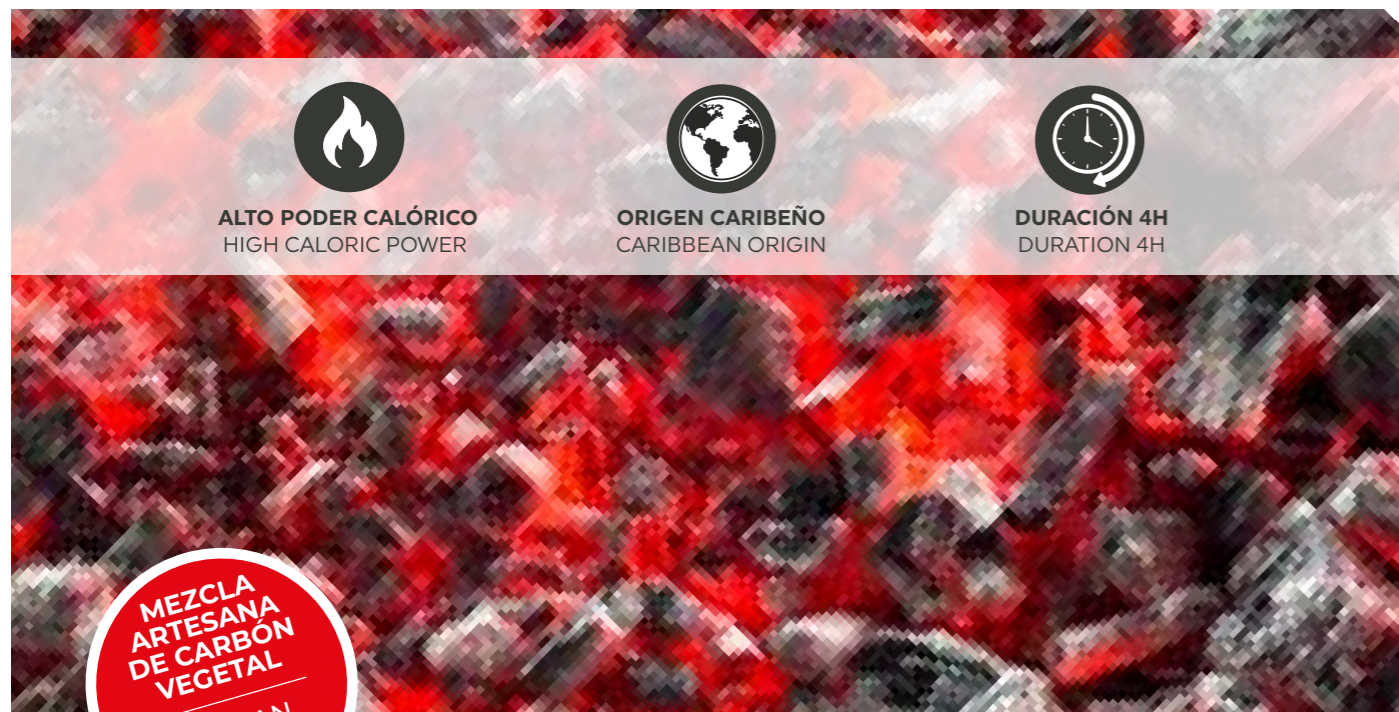

ALTO PODER CALÓRICO
HIGH CALORIC POWER



ORIGEN CARIBEÑO
CARIBBEAN ORIGIN



DURACIÓN 4H
DURATION 4H

**MEZCLA
ARTESANA
DE CARBÓN
VEGETAL**
**ARTISAN
CHARCOAL
BLEND**



MARABÚ

Alta densidad y poder calórico. Aromas nobles y baja producción de humo y ceniza.

High-density and high performance, noble aromas and low smoke and ash production.



CASUARINA

De muy alto poder calórico, proporcionando potencia y un mayor rendimiento.

Higher efficiency, providing power and increased performance.



JÚCARO

Aporta estabilidad y control a la mezcla aportando una mayor eficiencia y durabilidad.

It provides stability and control to the blend giving more efficiency and durability.

NEW

Saco de carbón vegetal marabú, casuarina y jucaro
Vegetable charcoal marabú, casuarina and jucaro
Charbon végétal marabú, casuarina et jucaro
Carbone vegetale marabú, casuarina e jucaro
Pflanzliche kohle marabú, casuarina und jucaro



El cumplimiento de la normativa REACH garantiza el control de calidad del producto, descartando la deforestación de bosques y la mano de obra infantil.

REACH compliance guarantees product quality control, ruling out deforestation of forests and child labour.

REF.	PESO(kg)	€	UE / MOQ
11058	10		1-0-1-0-0 / 1

Leña de vid procedente de viñedos de 100 años de antigüedad. Cortados en trozos pequeños y manejables que mantienen un excelente aroma.

Vine wood from 100 year old vineyards. Cut into small, manageable pieces that maintain an excellent aroma.

NEW

Madera de Vid
Vine Vid
Bois de vigne
Legno di vite
Rebenholz



REF.	PESO(kg)	€	UE / MOQ
12014	7 APROX		1-0-0-0-0 / 1

**FRESCO
FRESH**

Envasado según pedido para garantizar la máxima frescura y preservar todos los beneficios del producto.

We pack to order to guarantee maximum freshness and preserve all the benefits of the product.



REF: 11975

**SHUNKS
DE RAÍZ DE VID**

- Granulometría gruesa hasta 100mm.
Coarse granulometry 100mm.

- Apto para smokers, kamados y técnicas de ahumados de larga duración.
Suitable for smokers kamados and long-lasting smoked.

- No necesita hidratación.
No hidratation needed.

NEW

Bbq Aroma, Bbq Flavour, Bbq arôme, Aroma bbq, Bbq geruch.

REF.	PESO(kg)	€	UE / MOQ
11975	2		1-0-0-0-0 / 1
11976	2		1-0-0-0-0 / 1
11977	0,150		1-0-0-0-0 / 1



REF: 11976

**CHIPS CASCARA
ALMENDRA**

- Granulometría media hasta 50mm.
Coarse granulometry 50mm.

- Apto para hornos de brasa, bbq abiertas para aromatización rápida.
Suitable for ember oven, open bbq for quick aromatisation.

- No necesita hidratación.
No hidratation needed.



REF: 11977

**SERRÍN DE RAÍZ
OLIVO / ALMENDRO**

- Granulometría fina.
Fine granulometry.

- Apto para aromatizadores, para aportar aromas a las elaboraciones gastronómicas y del mundo del cocktail.
Suitable for aromatisers to provide flavoring to gastronomical elaborations and cocktail world.



**ENVASADO
SEGÚN
PEDIDO**
**PACKED
TO ORDER**



UTSET + comas

Utset y Comas se unen para poner al alcance de todos, una selección de productos minuciosamente diseñados y fabricados siguiendo los estándares de calidad de una empresa familiar con 130 de experiencia dedicados con pasión al mundo del cuchillo y su cuidado.

Este compromiso asegura la máxima calidad de nuestros productos al precio más competitivo del mercado con una orientación eficiente y personalizada.

Utset and Comas join forces to make available to everyone a selection of products meticulously designed and manufactured following the quality standards of a family company with 130 years of experience passionately dedicated to the knives world and their care.

This commitment ensures the highest quality of our products at the most competitive price in the market with efficient and personalised guidance.





CUCHILLOS DE MESA



El cuchillo de mesa UTSET, es el resultado de la demanda de restaurantes gastronómicos que deseaban poner en mesa un cuchillo de líneas muy elegantes pero a la vez discreto y sencillo, y sobre todo que cumpliera con los altos requisitos de este tipo de restaurante.

El diseño de este cuchillo en acabados de madera de olivo, de ébano y todo el surtido de colores en madera de haya estabilizada, cumple con nuestras exigencias en cuanto a ergonomía para sus medidas y unas líneas fluidas para obtener un resultado final muy elegante.

La dureza del acero dota de resistencia al filo en contacto con el plato además de permitir una fácil recuperación al afilarlo con piedra o diamante.

Gracias a la colaboración UTSET + COMAS, hemos conseguido reproducir estos cuchillos con los mismos estándares de calidad y diseño con un menor coste, logrando que sean asequibles para un mayor número de profesionales y particulares que desean calidad y exclusividad en su mesa.

Hoy en día este cuchillo ya está presente en grandes restaurantes de todo el mundo.

The UTSET table knife is the result of the demand of gastronomic restaurants that wanted to put on the table a knife with very elegant lines, but at the same time discreet and simple and above all that meets the high requirements of this type of restaurant.

The design of this knife in ebony olive wood finish and the whole range of stabilised beech wood colours meets our requirements in terms of ergonomics for its dimensions and fluid lines to obtain a very elegant result.

The hardness of the steel makes the cutting edge resistant when in contact with the plate and allows for easy recovery when sharpened with a stone or diamond.

Thanks to the UTSET+ COMAS collaboration we have managed to reproduce these knives with the same quality and design standards at a lower cost, making them affordable for a greater number of professionals and individuals who want quality and exclusivity at their table.

Nowadays this knife is already present in great restaurants all over the world.





**MESTRE MAURICI
COLLECTION**

CARBON STEEL:
JAPANESE STEEL 52100
HARDENESS 62 ± 2 HRC
BLACKEN BLADE



De la colaboración entre Utset y Comas surge una nueva línea de cuchillos de inspiración japonesa que combina tradición y tecnología de vanguardia. Un cuchillo de alta gama que cumple todas las exigencias de expertos cocineros.

La colección Mestre Maurici, denominada así en memoria del fundador de Utset, combina el profundo conocimiento acumulado a lo largo de los 130 años de experiencia con las técnicas artesanales niponas, famosas por su precisión y excelencia.

Su forma ergonómica, pensada para ofrecer una sensación de ligereza y equilibrio en el peso, busca reducir la fatiga y mejorar la precisión en el corte.

The collaboration between Utset and Comas has given rise to a new line of Japanese-inspired knives that combines tradition and cutting-edge technology.

The Mestre Maurici collection, named in memory of Utset's founder, combines the profound knowledge accumulated over 130 years of experience with Japanese craftsmanship techniques, renowned for their precision and excellence.

Its ergonomic shape, designed to offer a sensation of lightness and balance in weight, aims to reduce fatigue and improve cutting precision.





Desde que se empezó a forjar la unión entre UTSET y Comas, nuestro reto ha sido siempre poder ofrecer lo que para nosotros son algunos de los mejores cuchillos del mercado mundial.

Después de casi dos años buscando la excelencia, y ayudados por algunos de los más experimentados chefs del país, tenemos el placer de presentaros nuestra colección 130.

Su diseño ha sido modificado varias veces, para que un mismo cuchillo se comporte a la perfección en distintas técnicas de corte.

El anillo del mango simboliza el compromiso entre UTSET y COMAS y al mismo tiempo, nuestro compromiso con cada uno de nuestros clientes.

Since the union between UTSET and Comas began to be forged, our challenge has always been to offer what we consider to be some of the best knives on the world market.

After almost two years of searching for excellence, and with the help of some of the most experienced chefs in the country, we are pleased to present our 130 collection.

Its design has been modified several times, so that the same knife performs perfectly in different cutting techniques.

The ring on the handle symbolises the commitment between UTSET and COMAS and, at the same time, our commitment to each of our customers.



El cuchillo es un instrumento personal e intransferible. Por eso, **afilarlo y guardarlo en un lugar correcto es una parte importantísima del proceso de mantenimiento y uso**, al igual que saber elegir el cuchillo adecuado para cada tipo de corte. Porque un alimento bien cortado libera mejor su sabor y eso se transmite en el plato.

The knife is a personal and non-transferable instrument. Sharpening it and keep it therefore a very important maintenance and usage process, as it knowing how to choose the right knife for each type of cut. Because a well-cut food releases its flavour and this is transmitted to the plate.



PUENTE BAMBÚ
BAMBOO BRIDGE



#400 #1000 #3000 #5000

PIEDRAS DE AFILADO NANIWA



PLACA DIAMANTADA D8X - DMT
DIAMOND PLATE

PIEL DE NOBUCK VIRGEN:
para el pulido y acabado final del afilado.

VIRGIN NOBUCK LEADER:
For polishing and final finishing of sharpening.



ASENTADOR DOBLE CARA
DOUBLE-FACED SETTLER

ÓXIDO DE CROMO:
para el asentado del cuchillo.

CHROME OXIDE:
For knife seating.



MALETÍN PORTACUCHILLOS
KNIFE-HOLDER CASE

L U E S M A  V E G A +  comas



Luesma & Vega es un estudio dedicado al diseño y producción de objetos artísticos en vidrio con técnicas contemporáneas que ha colaborado con diseñadores, decoradores y empresas, resolviendo sus necesidades.

En todos nuestros proyectos desde el inicio hay la voluntad de producir objetos bellos y duraderos, que nos acompañen y aumenten de valor con el tiempo, por eso son reparables, transformables y al final de su vida totalmente reciclables.

No queremos llenar el mundo de objetos inútiles e indiferentes, nuestras producciones son muy cuidadosas y respetuosas con el medio ambiente. Producimos a mano, una a una y en series muy limitadas con procesos no industriales

Este compromiso garantiza la máxima calidad de nuestros productos al precio más competitivo del mercado, con un asesoramiento eficaz y personalizado.

LUESMA & VEGA is a studio dedicated to the design and production of artistic glass objects using contemporary techniques that has collaborated with designers, decorators and companies to meet their needs.

In all our projects from the beginning there is the desire to produce beautiful and durable objects that accompany and increase their value over time, that is why they are repairable, transformable, and at the end of their life totally recyclable.

We do not want to fill the world with useless and indifferent objects. Our productions are truly environmentally friendly. We produce by hand one by one and in very limited series with non-industrial processes.

This commitment ensures the highest quality of our products at the most competitive price in the market with efficient and personalised guidance.





En colaboración con Luesma y Vega, Comas amplía su catálogo ofreciendo una familia compuesta de platos y soportes para snacks .

In collaboration with Luesma and Vega, Comas expands its catalogue by offering a family of plates and snack stands.

Una línea de elementos que puede cubrir fácilmente una presentación en mesa, un catering o buffet gracias a la diversidad de sus formas y tamaños que facilitará cualquier emplatado.

A line of elements that can easily cover a table presentation, a catering or buffet thanks to the diversity of its shapes and sizes that will facilitate any plating.

Con estética vintage, su color ambar que da nombre a la colección y un grabado moresco muy elegante, estas piezas son el aliado perfecto para cualquier servicio.

With vintage aesthetics, the amber colour that gives the collection its name and a very elegant moresque engraving, these pieces are the perfect ally for any service.



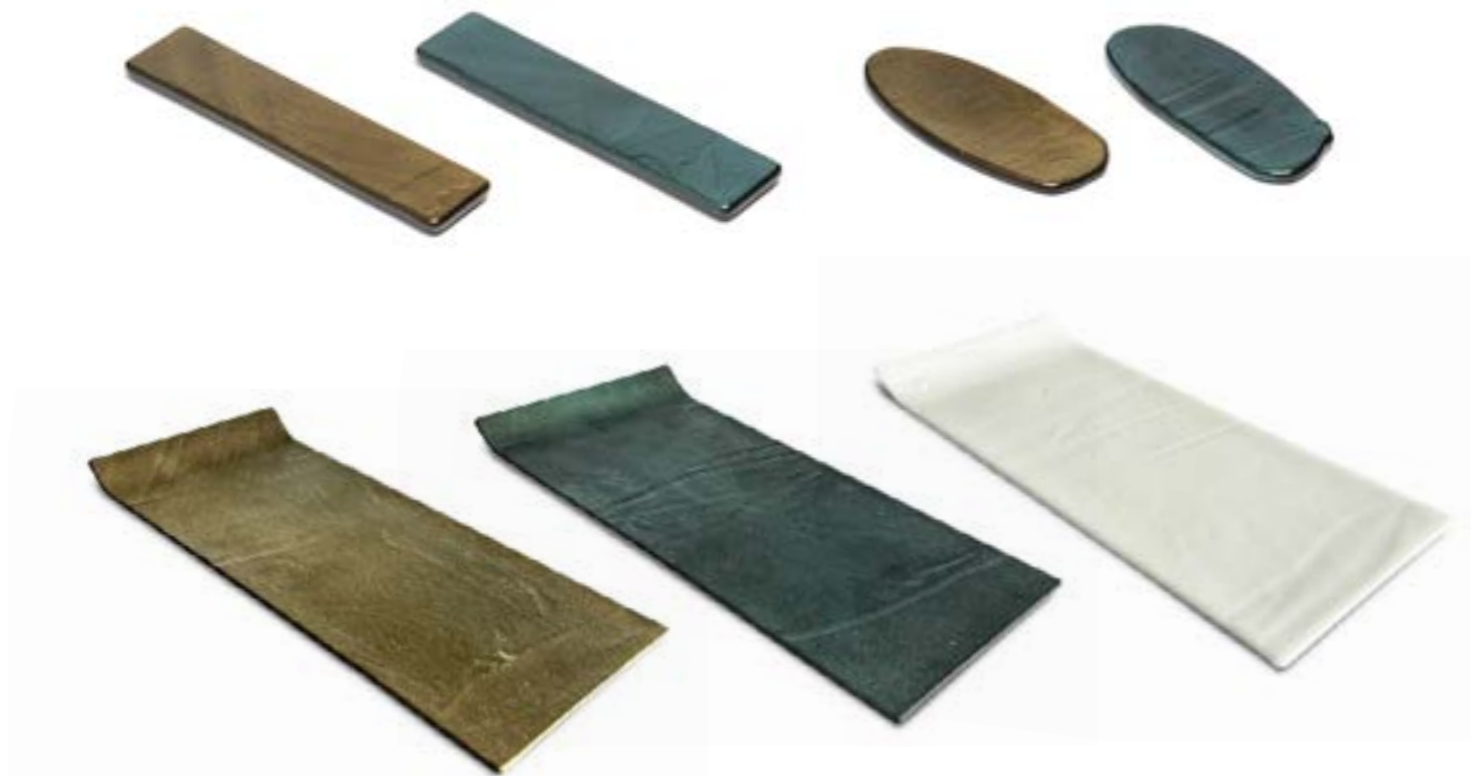

Muna Velvet es una exquisita colección de reposacubiertos, reposacucharillas y cucharillas de degustación elaborados en vidrio texturizado con un elegante acabado irisado.

Cada pieza refleja un brillo único que evoca sofisticación y delicadeza, convirtiéndola en el complemento perfecto para embellecer cualquier mesa o experiencia gastronómica.

La combinación de diseño funcional y estética deslumbrante hacen de Muna Velvet una elección ideal para quienes buscan estilo y distinción en cada detalle.

Muna Velvet is an exquisite collection of cutlery holders, spoon rests and tasting spoons crafted from textured glass with an elegant iridescent finish.

Each piece reflects a unique sheen that evokes sophistication and delicacy, making it the perfect complement to embellish any table or dining experience.

The combination of functional design and dazzling aesthetics make Muna Velvet an ideal choice for those seeking style and distinction in every detail.

bahigüell + comas

Hemos unido fuerzas con bahigüell, agencia de diseño de producto, que cuenta con una amplia experiencia en el sector gastronómico.

Aportando nuestra experiencia como fabricantes para trabajar juntos en la creación de nuevos productos gastronómicos modernos, atemporales y funcionales.

Creemos firmemente que una colaboración como esta crea una sinergia entre ambas compañías, brindando a los clientes productos innovadores que harán que su uso sea más fácil y placentero.

We have joined forces with a product design agency that has extensive experience in the gastronomic sector.

Bringing our experience as manufacturers to work together in the creation of new modern timeless and functional gastronomic products.

We strongly believe that a collaboration like this creates a synergy between the two companies providing customers with innovative products that make their daily use easier and more enjoyable.





Comas presenta LES ESSENCES, una colección pensada para vivir la experiencia de un catering exclusivo, con piezas de diseño, de líneas actuales, que se complementan entre ellas para crear una colección única.

Cada pieza es una y múltiple de la siguiente con lo que se consigue una perfecta disposición en sala, donde el equilibrio y la elegancia llenan el espacio, así como un fácil almacenaje tras cada pase.

Piezas fabricadas en materiales ligeros con formas polivalentes que optimizan las posibilidades de uso de cada una de ellas. El estudio previo de las necesidades en el servicio de catering, han dado como resultado esta gama de productos versátil capaz de satisfacer tanto a los más tradicionales como a los más transgresores.

Comas presents LES ESSENCES, a collection designed to live the experience of an exclusive catering, with designer pieces, with modern lines, which complement each other to create a unique collection.

Each piece is one and a multiple of the next, thus achieving a perfect arrangement in the room, where balance and elegance fill the space, as well as easy storage after each pass.

Pieces made of light materials with multi-purpose shapes that optimise the possibilities of use of each one of them. The previous study of the needs of the catering service has resulted in this versatile range of products capable of satisfying both the most traditional and the most transgressive.

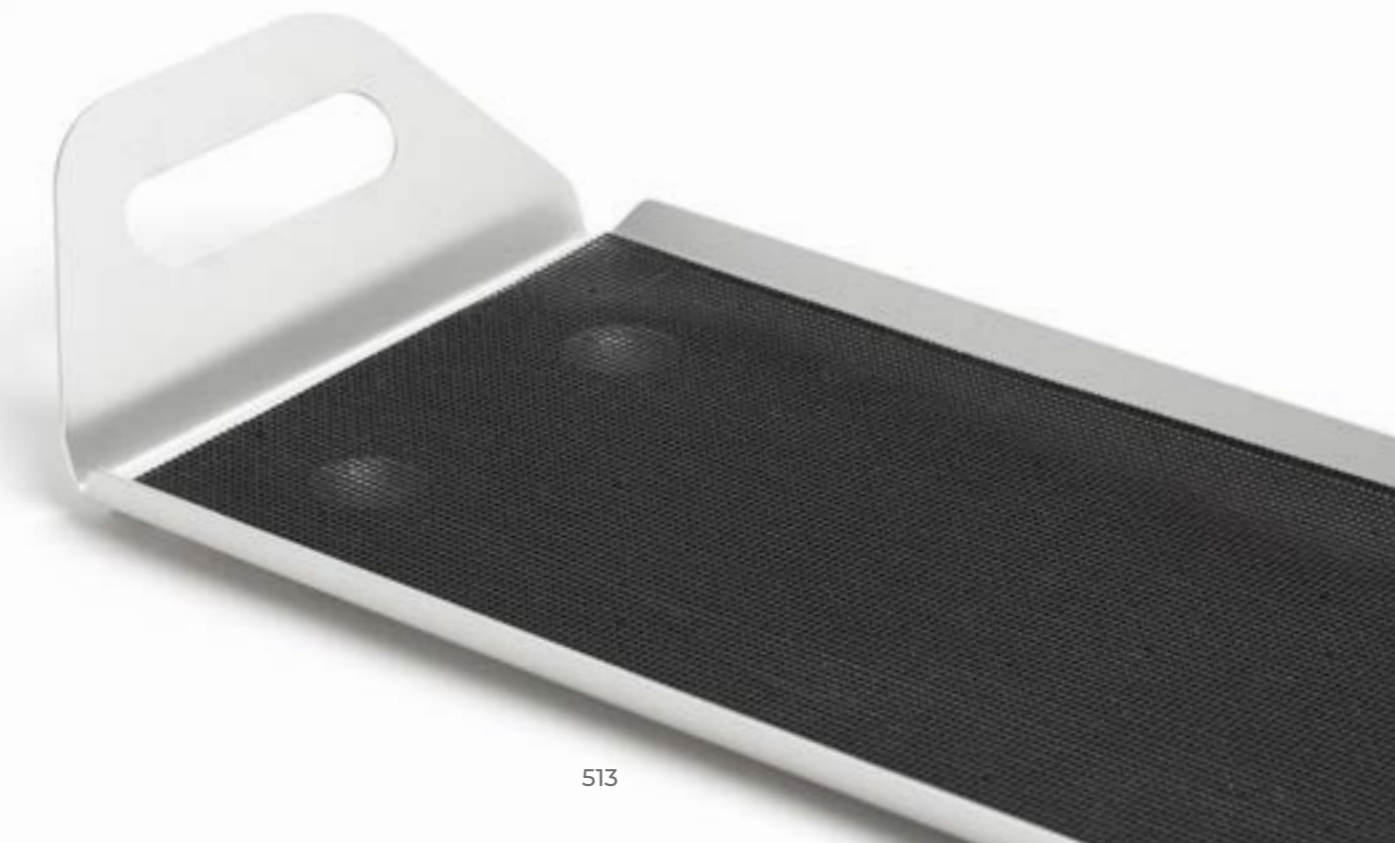



PREMIOS DELTA



PREMIOS CACTUS



PREMIOS INNOFÒRUM

CALIU & comas

Hemos unido fuerzas con bahígüell, agencia de diseño de producto, que cuenta con una amplia experiencia en el sector gastronómico. Aportando nuestra experiencia como fabricantes para trabajar juntos en la creación de nuevos productos gastronómicos modernos, atemporales y funcionales.

Creemos firmemente que una colaboración como esta crea una sinergia entre ambas compañías, brindando a los clientes productos innovadores que harán que su uso regular sea más fácil y placentero.

We have joined forces with bahígüell, a product design agency with extensive experience in the gastronomic sector. We bring our experience as manufacturers to work together in the creation of new modern, timeless and functional gastronomic products.

We firmly believe that a collaboration like this creates a synergy between both companies, providing customers with innovative products that will make their regular use easier and more enjoyable.

CALIU COLLECTION

Cobranding

Caliu es una marca de conceptos gastronómicos diseñados para crear experiencias únicas.

Caliu es un conjunto de artículos pensado para el entorno profesional actual. Fácil de usar, versátil y robusta, con un equilibrio perfecto entre estética, funcionalidad y practicidad.

Caliu is a fine dining brand designed to create unique experiences.

Caliu is a set of devices designed for today's professional environment. Easy to use, versatile and robust, with a perfect balance between aesthetics, functionality and practicality.



Discover
 Caliu's
 World

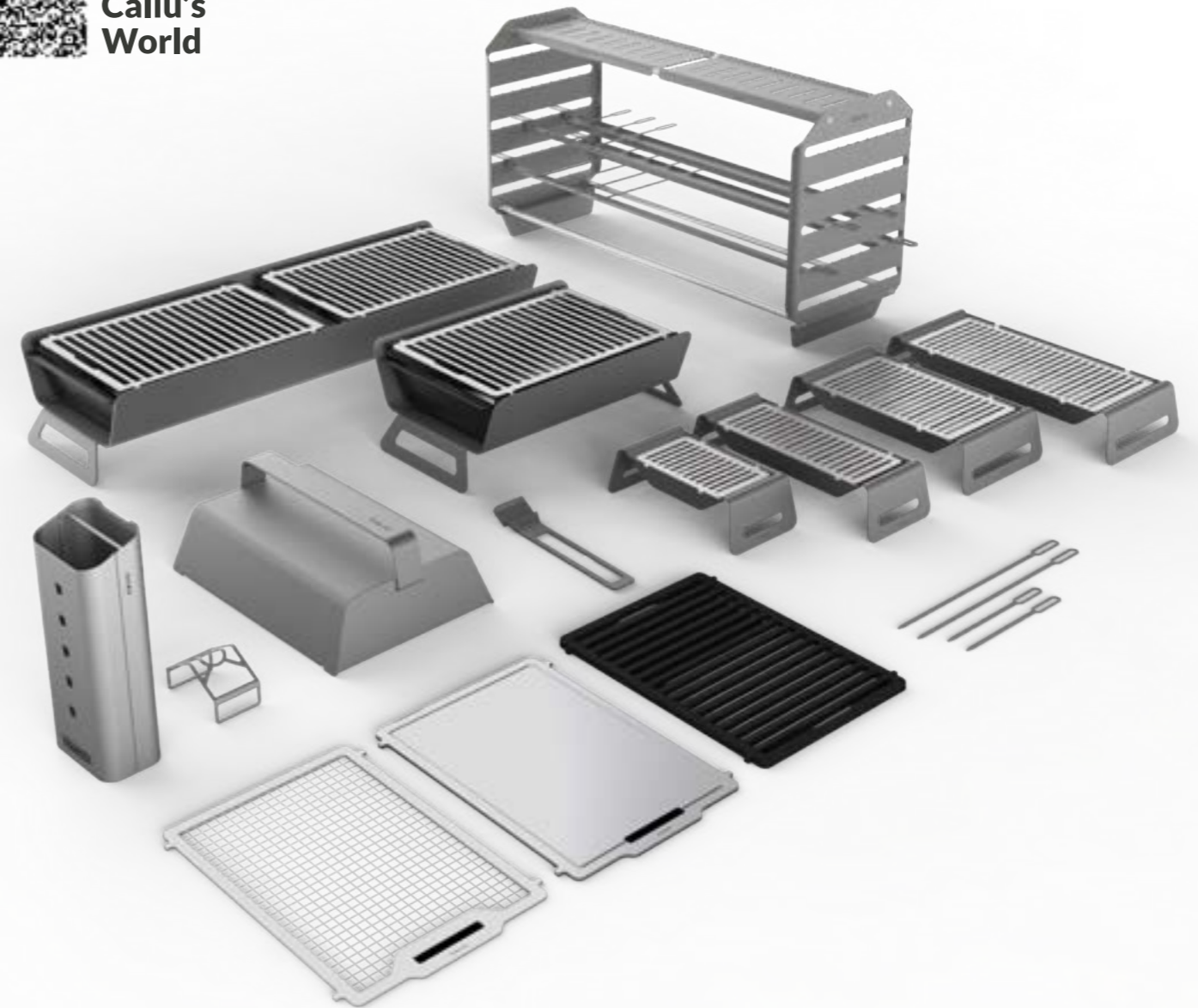

Los mejores restaurantes y Chefs han confiado en CALIU / The best restaurants and Chefs have trusted in CALIU

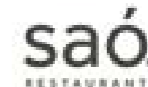
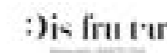
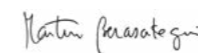



Isidre Buxó Caelles con 35 años de experiencia en el sector de las brasas de leña, carbón y ahumados, ha consolidado su posición en el mercado gracias a su experiencia y dedicación, convirtiéndose en un referente en el sector.

Cocinero autodidacta y especializado en los orígenes de la cocina a la brasa, es profesor del CIB (Culinary Institute of Barcelona).

Gerente y fundador desde sus inicios en el 1994, su empresa, Llenyes i Carbons del Vallès, se dedica a la selección y manipulación de carbones artesanales y leñas selectas para profesionales de la restauración. Su propósito es ayudar a los profesionales del sector a valorar el oficio del arte ancestral de la cocina a la brasa.

Su Know How y bagaje en el mundo de los carbones, son el motivo por el que Comas se une a Isidre, con el objetivo de ofrecer el combustible de mayor calidad a nuestros clientes.

“Isidre Buxó Caelles, with 35 years of experience in the wood, charcoal and smoked meats sector, has consolidated his position in the market thanks to his experience and dedication, becoming a benchmark in the sector.

A self-taught chef specialising in the origins of charcoal-grilled cuisine, he is a professor at the CIB (Culinary Institute of Barcelona).

Manager and founder since its beginnings in 1994, his company, Llenyes i Carbons del Vallès, is dedicated to the selection and manipulation of artisan coals and selected firewood for professionals in the restaurant industry. Its aim is to help professionals in the sector to value the craft of the ancestral art of charcoal-grilled cooking.

His know-how and experience in the world of coals are the reason why Comas joins Isidre, with the aim of offering the highest quality fossil fuel to our customers.





Con el objetivo de ofrecer productos de máxima calidad, Comas confía en Carbons Vallès quien garantiza que su carbón cumple la normativa de control de calidad REACH.

Nuestro carbón proviene de talas controladas de Cuba evitando así la deforestación y la mano de obra infantil.

With the aim of offering products of the highest quality, Comas trusts Carbons Vallès, which guarantees that its charcoal complies with regulations quality control-REACH.

Our charcoal comes from controlled logging in Cuba, thus avoiding deforestation and child labour.

Carbón estrella en cuanto a calibrado, aroma y rendimiento. Se caracteriza por su larga duración, alta temperatura y ausencia de chispas.

Star charcoal in terms of calibration, aroma and performance, characterised by its long life, high temperature and absence of sparks.



La experiencia de Isidre nos ayuda a ofrecer los mejores productos para que nuestros chefs puedan trabajar al detalle sus elaboraciones.

Añadimos una selección exclusiva de aromatizadores para brasa, de diferentes materias primas y en diferentes texturas. Todos ellos seleccionados meticulosamente para potenciar los ahumados.

Isidre's experience helps us to offer the best products so that our chefs can work in detail on their preparations.

Adding an exclusive selection of flavourings for embers, from different raw materials and in different textures. All of them meticulously selected to enhance the smoked products.



AMT proporciona productos que destacan en el mercado, satisfaciendo las demandas más exigentes de los chefs en su trabajo diario. Cada producto AMT está pensado y diseñado con la innovación en mente, de lo que surgen productos de cocina más duraderos y eficientes

Por eso en COMAS confiamos en la calidad de los productos AMT para completar nuestro catálogo y ofrecer a nuestro cliente una gama de productos de cocina de la más alta calidad.

* Plazo de entrega 1 mes / Delivery time 1 month.

AMT provides products that stand out in the market, meeting the highest demands of chefs in their daily work. Every AMT product is conceived and designed with innovation in mind, resulting in more durable and efficient kitchen products.

That is why at COMAS we rely on the quality of AMT products to complete our catalogue and offer our customer a range of kitchen products of the highest quality.



RISOLÍ

IL PRESSOFUSO IN CUCINA



Risolì ofrece una selección de sartenes, planchas, cacerolas y cazuelas que está estudiada, diseñada y cuidada hasta el más mínimo detalle, con el objetivo de garantizar el máximo rendimiento en la cocina, realzando el sabor y el gusto de los platos. Una variedad de líneas para satisfacer cualquier tipo de cocina y dar rienda suelta a su creatividad con la calidad MADE IN ITALY.

Risolì offers a selection of frying pans, griddles, saucepans and casseroles that are studied, designed and cared for down to the smallest detail, with the aim of guaranteeing maximum performance in the kitchen, enhancing the flavour and taste of the dishes. A variety of lines to satisfy any type of kitchen and give free rein to your creativity with MADE IN ITALY quality.



**THERMO
FUTURE
BOX**

Empresa alemana fundada en 2001. Líder del mercado europeo con más de 100 cajas de EPP diferentes para el transporte de productos frescos, calientes o fríos. La marca THERMO FUTURE BOX trabaja constantemente en nuevos conceptos para productos optimizados que se caracterizan por su funcionalidad, diseño, manejo, versatilidad y seguridad.

German company founded in 2001. European market leader with more than 100 different EPP boxes for the transport of fresh, hot or cold products. The THERMO FUTURE BOX brand is constantly working on new concepts for optimised products that are characterised by functionality, design, handling, versatility and safety.

Nuestro Know How en la fabricación de cubiertos se refleja en cada detalle, desde el proceso de diseño hasta el producto final, Comas despliega su experiencia para transformar la materia prima en piezas de la más alta calidad.

Our know-how in the manufacture of cutlery is reflected in every detail, from the design process to the final product, Comas deploys its experience to transform raw materials into pieces of the highest quality.

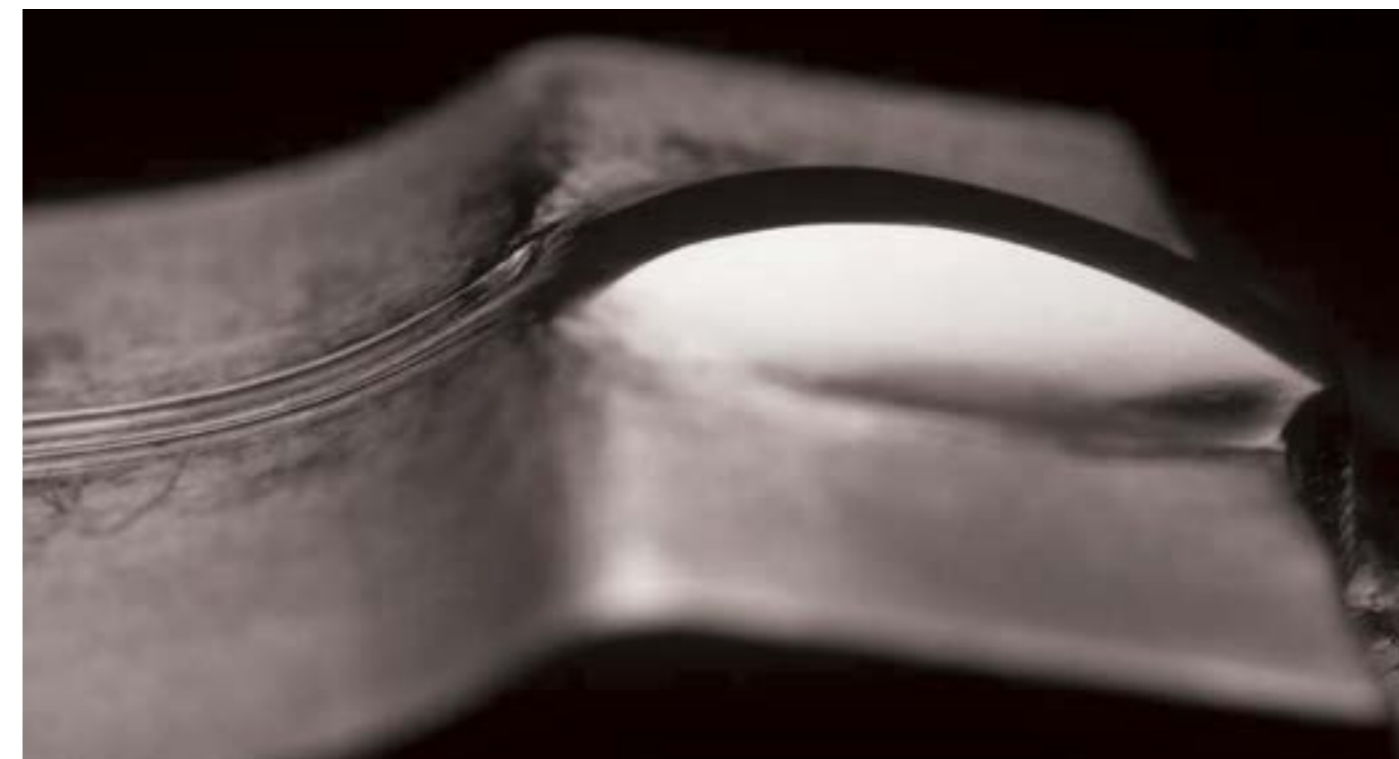

Bobina
ACERO INOXIDABLE
Stainless steel coil

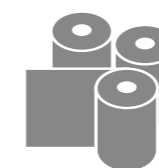

1

Material con el que se inicia la fabricación de los cubiertos.
Material with which the manufacture of cutlery begins.

Corte
Blanking



2

Se crea una forma geométrica plana (o "pieza en blanco") al introducir la bobina en una prensa y un troquel.
A geometric shape (or "blank") is created by feeding a coil of sheet metal into a press and die.

Laminación
Rolling



3

Proceso de rebaje hasta conseguir el grosor y forma correcta al pasar entre rodillos que giran en dirección opuesta.
The process of trimming to the correct thickness and shape by passing between rollers rotating in the opposite direction.

Recorte
Cutting



4

Proceso de corte donde se separa la pieza de chapa aplicando una fuerza grande para provocar la rotura del material.
Cutting process where the piece of sheet metal is separated by applying a large force to cause the material to break.

Embutición
Embossing



5

Proceso de estampado para producir diseños en relieve o hundidos o relieves en chapa.
Stamping process to produce embossed or sunken designs or reliefs on sheet metal.

Pulido
Polished



6

Proceso de afinado de forma para alisar superficies, eliminar rayones y muescas y escalar la superficie.
Shape refining process to smooth surfaces, remove scratches and indentations, and scale the surface.

Mantenimiento de cubiertos Cutlery care



Prelavado Prewash

Después de su uso, eliminar los restos de comida que podamos con la ayuda de una esponja suave.

After use, remove any food residue with a soft sponge.

Sumergirlos en agua.

Submerge them in water.



Lavado en lavavajillas Dishwasher wash

Al introducir los cubiertos en el cesto del lavavajillas, recomendamos ponerlos verticalmente con las hojas hacia arriba.

When placing cutlery in the dishwasher basket, we recommend placing them vertically with the blades facing upwards.

No utilizar detergentes excesivamente abrasivos.

Don't use excessively abrasive detergents.

Utilizar un detergente de calidad.

Use a quality detergent.

Usar un programa de lavado a temperatura inferior a 80°C y detergente con fosfatos en cantidad inferior al 10%.

Use a wash programme below 80°C and detergent with phosphate content below 10%.



Secado Drying

Nada más terminado el lavado, secar los cubiertos para evitar manchas de gotas de agua y conseguir un brillo duradero.

As soon as you have finished washing, dry the cutlery to avoid water spots and to achieve a long-lasting shine.

Secar con un paño suave.

Dry with a soft cloth.



PVD

Las piezas PVD pueden lavarse a máquina.

PVD pieces could be washed in the dishwasher.

Usar un programa de lavavajillas inferior a 80°C

Use a wash programme below 80°C

La limpieza en lavavajillas se debe realizar en posición vertical.

Stand the cutlery upright in the dishwasher

El recubrimiento PVD garantiza una resistencia de hasta 500 ciclos de lavado.

The PVD coating guarantees a resistance of up to 500 washing cycles.

Mantenimiento de cuchillos Knives care



Prelavado Prewash

Después de su uso, eliminar los restos de comida que podamos con la ayuda de una esponja suave.

After use, remove any food residue with a soft sponge.



Lavado a mano Hand wash

No utilizar estropajos metálicos o sintéticos para evitar el rayado.

Don't use metallic or synthetic scouring pads to avoid scratching.

Evita los productos de limpieza abrasivos ni agua con exceso de cloro.

Avoid abrasive cleaning products or excessively chlorinated water.



Secado Drying

Secar con paño suave desde el lomo de la hoja hacia el filo y desde el mango hasta la punta.

Dry with a soft cloth from the back of the blade to the cutting edge and from the handle to the tip.



Almacenamiento y transporte Storage and transport

Una vez seco, guardar en un estuche, funda o imán para cuchillos. De esta manera preservaremos el filo en buen estado por más tiempo.

Once dry, store in a case or sheath or in a knife magnet. This will preserve the sharpness for a longer period of time.



Afilado Sharpening

Es conveniente repasar el afilado de los cuchillos periódicamente para mantener la calidad del filo y la seguridad y precisión del corte.

It is advisable to sharpen knives regularly to maintain the quality of the cutting edge and the safety and precision of the cut.

Custom Packs

- MAZOS
- GRANADA / BAGUETTE
 - CUBA / LUNA
 - MADRID / BARCELONA / MUNICH
 - VIENA / LONDON
 - BILBAO / INGLES / MALVARROSA
 - MIA / ONLINE / CHEESE
 - IBIZA / OSLO / HIDRAULIC / NICE
 - HOTEL / ALIDA / CANADA
 - SEVILLA / CHEF / NORTH



1



8



9



10



2

????



3



4



11



12



5



6



7



13

1. MAZOS Para cuchillos, cucharas y tenedores 2. CAJA 12 UNIDADES PVC Box 12 units PVC 3. BLISTER CHULETEROS Blister knives 4. BLISTER 4 PIEZAS FINGER FOOD Blister 4 units Finger Food 5. BLISTER CARTÓN COMAS Blister Comas 6. CAJA 12 UNIDADES VENTANA Box 12 units window 7. CAJA 12 UNIDADES VENTANA KRAFT Box 12 units windows kraft 8. CAJA 6 CHULETEROS MADERA Wood box 6 steak knife 9. CAJA 6 CHULETEROS KRAFT Kraft box 6 steak knife 10. CAJA 12 UNIDADES Box 12 units 11. CAJA 16 , 24 Y 30 UNIDADES COMAS Comas Box 16, 24 and 30 units 12. CAJA 16 , 24 Y 30 UNIDADES COMAS AUTOR Comas Autor Box 16, 24 and 30 units 13. ESTUCHE 24 PIEZAS MADERA 24 pieces wooden pack.

NEW

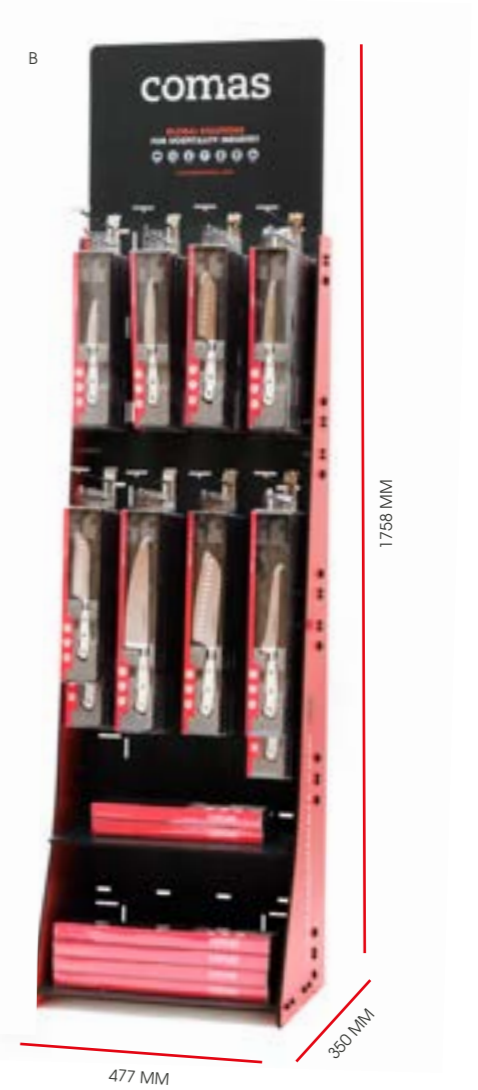
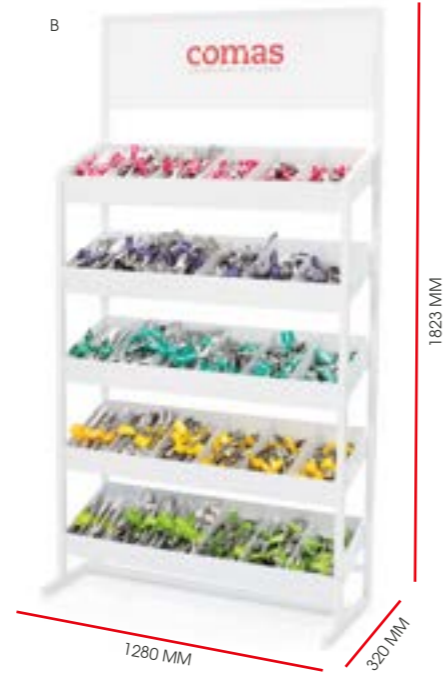

	€	✕ mm	✕ mm	🔪	🔪
A 7531 MUEBLE EXPOSITOR DOCENAS COMAS hospitality dozen comas display stand	763,38 €	1200	1850	4 COLEC. 1 MASTER POR REF	2880 PIEZAS
B 5565 MUEBLE EXPOSITOR HOSTELERÍA horeca stand	817,56 €	1280	1823	5 COLEC. 1 MASTER POR REF	1440 PIEZAS
C 5564 MUEBLE EXPOSITOR BLISTER LACASA blister Lacasa stand white	257,67 €	480	2100	3 COLEC. + 27 REFERENCIAS	764 PACKS
D 6792 MUEBLE EXPOSITOR MENAJE kitchenware stand	261,51 €	675	2136	4 COLEC. 1 MASTER POR REF	2880 PIEZAS
E 5650 MUEBLE EXPOSITOR MADERA wood stand	808,82 €	542	1700	3 COLEC. 4 INNER POR REF	576 PIEZAS
F 6791 MUEBLE EXPOSITOR BLISTER / MAZO comas stand LACASA	510,97 €	480	2100	3 COLEC. + 27 REFERENCIAS	764 PACKS

	€	✕ mm	✕ mm
A 1881 MUEBLE EXPOSITOR MADERA MENAJE wooden exhibitor furniture kitchenware, exposant en bois meubles cuisine, esposito- re in legno mobile articoli da cucina, ausstellermöbel aus holz küchengeräte	517,66 €	801	2137
B 1884 MUEBLE EXPOSITOR MADERA CUCHILLOS wooden knives display furniture, mobilier de présentation de couteaux en bois, mo- bile espositore coltelli in legno, holzmesser ausstellungsmöbel	474,52 €	477	1758



G



H



I

G	5570	EXPOSITOR SOBREMESA COMAS counter display, présentoir 4 pièces, espositore da tavola, besteck-präsentations-ständer klein	30,53 €	235	320	1 COLEC.	4 PIEZAS
H	5571	EXPOSITOR SOBREMESA CUCHILLOS totem display stand, présentoir totem mobile, espositore totem, besteck-präsentations-ständer groß	53,42 €	400	330	1 COLEC.	7 PIEZAS
I	5648	EXPOSITOR BANDEROLA COMAS comas flag display stop rayon, comas espositore a bandiera, comas fahnen-besteck-display	53,42 €	440	270	1 COLEC.	4 PIEZAS
J	5646	MUEBLE EXPOSITOR TOTEM COMAS totem display stand, présentoir totem, mobile espositore, totem besteck-präsentations-ständer groß	325,17 €	301	1869	8-16 COLEC.	32-64 PIEZAS



J



A

1600 MM

440 MM

720 MM



B



C



D



E

A	7824	BASE MUEBLE EXPOSITOR NEGRO COMAS AUTOR comas autor display stand	693,98 €	720	1600	1 COLEC.	1 MASTER POR REF
A	7597	TABLERO EXPOSITOR MUEBLE MADERA COMAS black wooden display stand comas autor	25,02 €				
B	7780	AUTOR black wooden display stand lab	25,02 €				
C	7781	TABLERO EXPOSITOR MUEBLE MADERA LAB black wooden display stand comas kodai	25,02 €				
D	7782	TABLERO EXPOSITOR MUEBLE MADERA KODAI black wooden display stand sakura	25,02 €				
E	7888	TABLERO EXPOSITOR MUEBLE MADERA SAKURA black wooden display stand steak knives	25,02 €				
		TABLERO EXPOSITOR MADERA CHULETERO HQ					

€ \llcorner mm Σ mm

Sostenibilidad Sustainability



Trabajamos para desarrollar un proceso industrial sostenible con combustibles que contribuyen a reducir las emisiones de CO2.

We are working to develop a sustainable industrial process using fuel that helps to reduce CO2 emissions.



Diseñamos embalajes con materiales reciclables para crear el menor impacto medioambiental posible.

We are designing packaging with recyclable materials to reduce the environmental impact as far as possible.



Controlamos el vertido de residuos para proteger la sostenibilidad del planeta.

We monitor our waste disposal to protect the planet's sustainability.

Renovamos el compromiso ISO We renew our ISO commitment.

Acredita que en Comas aplicamos medidas de gestión medioambiental, con el fin de reducir el impacto de nuestra empresa en el medio ambiente.

Shows that Comas implements an environmental management system in order to reduce the impact of our business on the environment.



En los últimos años Comas ha trabajado para crear una compañía sostenible, social y medioambiental.

Trabajamos la sostenibilidad desde fases iniciales de diseño, desarrollando ideas y acciones que contribuyan a reducir daños en nuestro planeta y eviten el agotamiento de recursos. Desarrollamos valores sostenibles en todos los ámbitos de la compañía para una correcta gestión ambiental.

Certifica tanto la calidad en nuestro sistema productivo como en los procesos logísticos, administrativos y de dirección de Comas.

Shows the quality of Comas' system of production and logistical, administrative and management processes.



In recent years, Comas has been working to build a business that is sustainable both socially and environment.

We work to achieve sustainability from the early phases of design, concept development and take action to reduce harm to the planet and avoid over-use of resources. We follow values of sustainability in all areas of the business to ensure rigorous environmental management.

Índice referencia / Reference index

REF.	PAG.	REF.	PAG.	REF.	PAG.	REF.	PAG.	REF.	PAG.	REF.	PAG.	REF.	PAG.	REF.	PAG.	REF.	PAG.
7069	51	7153	164	7454	397	7514	386	7582	449	7793	387	7979	71	8348	281	8434	413
7070	51	7154	164	7455	397	7515	385	7583	459	7794	387	7980	57	8349	281	8435	413
7071	51	7155	164	7456	397	7516	385	7584	459	7795	387	7981	57	8350	281	8436	413
7072	51	7156	164	7457	397	7517	385	7585	458	7824	531	7982	57	8351	282	8437	423
7073	51	7157	164	7458	399	7518	385	7586	458	7826	387	7983	57	8352	282	8438	423
7074	51	7158	164	7459	399	7519	385	7587	458	7827	387	7984	57	8353	282	8439	269
7075	51	7159	164	7461	262	7520	385	7588	448	7828	387	7985	57	8354	282	8440	269
7076	51	7160	164	7462	262	7521	386	7589	449	7829	387	7986	57	8355	282	8441	269
7077	51	7207	141	7463	262	7522	386	7590	448	7830	390	7987	57	8356	282	8442	269
7078	51	7208	141	7464	262	7523	387	7591	449	7831	390	7988	57	8357	282	8443	269
7079	51	7209	141	7465	262	7524	387	7592	459	7832	390	7989	57	8358	282	8444	269
7080	51	7210	141	7466	262	7525	386	7593	459	7833	416	8000	41	8359	282	8445	269
7081	49	7211	141	7467	262	7526	386	7594	458	7834	416	8001	42	8370	42	8446	269
7082	49	7271	66	7468	262	7527	386	7595	458	7835	416	8002	41	8371	42	8447	269
7083	49	7272	66	7469	262	7528	386	7597	531	7836	416	8003	41	8373	171	8448	269
7084	49	7273	66	7470	262	7529	386	7598	398	7837	417	8004	41	8378	115	8449	269
7085	49	7274	66	7471	262	7530	386	7599	398	7838	417	8005	41	8381	486	8450	269
7086	49	7275	66	7472	262	7531	528	7621	55	7839	417	8006	41	8382	486	8451	275
7087	49	7276	47	7473	263	7532	192	7624	55	7840	402	8007	57	8383	486	8452	275
7088	49	7277	51	7474	263	7533	392	7625	55	7841	111	8008	57	8384	270	8453	275
7089	49	7278	49	7475	263	7534	392	7626	55	7842	111	8009	168	8385	270	8470	248
7090	49	7279	47	7476	263	7535	223	7627	55	7843	111	8010	168	8386	270	8471	248
7091	49	7280	51	7477	263	7536	223	7628	55	7844	111	8083	156	8387	400	8472	248
7092	49	7281	49	7478	263	7537	223	7629	55	7845	451	8084	156	8388	400	8473	422
7093	402	7285	47	7479	263	7538	223	7630	55	7846	451	8085	156	8389	400	8474	259
7094	402	7286	51	7480	380	7539	389	7665	37	7847	451	8086	156	8390	402	8476	261
7095	402	7287	49	7481	380	7540	389	7670	452	7848	451	8087	156	8391	402	8479	409
7096	402	7288	79	7482	380	7541	416	7671	453	7869	45	8088	156	8392	400	8480	274
7097	402	7418	66	7483	380	7542	389	7672	453	7888	531	8108	234	8393	400	8481	274
7098	402	7419	66	7484	380	7543	389	7673	453	7889	428	8109	234	8394	402	8482	274
7099	402	7420	66	7485	380	7544	389	7674	381	7890	33	8110	234	8395	423	8483	274
7100	402	7421	138	7486	380	7545	389	7675	381	7891	33	8111	234	8396	423	8484	274
7101	402	7422	138	7487	380	7546	389	7676	381	7899	118	8112	235	8398	267	8485	274
7102	379	7423	138	7488	380	7548	389	7677	381	7900	118	8113	235	8399	267	8486	274
7103	379	7424	138	7489	380	7549	417	7678	381	7901	118	8114	235	8400	267	8487	274
7104	379	7425	153	7490	377	7550	417	7679	452	7902	116	8115	235	8401	267	8488	274
7105	379	7426	153	7491	376	7551	116	7680	453	7903	116	8116	234	8402	267	8489	274
7106	379	7427	153	7492	377	7552	119	7681	453	7917	153	8117	234	8403	267	8500	467
7107	379	7428	153	7493	376	7553	117	7737	67	7930	450	8118	235	8404	267	8505	291
7112	393	7429	153	7494	377	7554	138	7765	74	7931	451	8119	235	8405	267	8507	259
7113	409	7430	153	7495	376	7555	138	7766	74	7957	66	8181	469	8406	267	8508	192
7116	428	7431	196	7496	377	7564	457	7767	74	7958	429	8182	475	8407	267	8509	283
7119	94	7432	196	7497	376	7565	457	7770	74	7959	429	8183	475	8413	407	8510	283
7120	96	7433	196	7498	379	7566	457	7771	74	7960	428	8184	170	8414	407	8511	283
7121	100	7438	451	7499	379	7567	457	7772	74	7963	119	8301	223	8415	407	8512	283
7122	97	7439	451	7500	379	7568	457	7773	74	7964	119	8302	223	8416	407	8513	283
7123	104	7440	451	7501	382	7569	457	7774	74	7965	117	8303	223	8417	407	8514	283
7124	105	7441	451	7502	382	7570	457	7775	74	7966	117	8304	223	8418	407	8515	283
7142	164	7442	200	7503	382	7571	457	7776	74	7968	71	8334	170	8419	407	8516	283
7143	164	7443	200	7504	383	7572	457	7778	398	7969	71	8335	170	8420	407	8517	283
7144	164	7445	199	7505	383	7573	457	7779	398	7970	71	8336	170	8421	407	8518	283
7145	164	7446	199	7506	382	7574	457	7780	531	7971	71	8337	170	8426	410	8519	283
7146	164	7447	199	7507	382	7575	457	7781	531	7972	71	8338	170	8427	410	8520	283
7147	164	7448	258	7508	382	7576	457	7782	531	7973	71	8342	281	8428	410	8523	219
7148	164	7449	262	7509	382	7577	457	7784	81	7974	71	8343	281	8429	413	8525	219
7149	164	7450	262	7510	382	7578	457	7789	383	7975	71	8344	281	8430	422	8526	219
7150	164	7451	397	7511	386	7579	448	7790	383	7976	71	8345	281	8431	413	8527	219
7151	164	7452	397	7512	386	7580	449	7791	383	7977	71	8346	281	8432	410	8529	220
7152	164	7453	397	7513	386	7581	448	7792	387	7978	71	8347	281	8433	410	8532	220

Índice referencia / Reference index

REF.	PAG.	REF.	PAG.	REF.	PAG.	REF.	PAG.	REF.	PAG.	REF.	PAG.	REF.	PAG.	REF.	PAG.	REF.	PAG.
8640	37	8955	281	9714	265	9976	281	10049	317	10108	229	10192	322	10263	325	10596	329
8641	37	8956	281	9715	265	9984	42	10050	317	10109	228	10194	322	10264	307	10612	330
8642	37	8957	281	9716	265	9985	371	10051	317	10110	228	10195	322	10265	325	10614	330
8643	37	8958	282	9717	265	9986	371	10052	317	10111	228	10196	322	10266	325	10615	330
8644	37	8959	282	9718	265	9987	371	10053	317	10112	228	10197	323	10267	325	10617	329
8645	37	8960	282	9719	265	9988	371	10054	318	10113	228	10199	323	10268	325	10618	329
8646	37	8961	282	9720	265	9989	371	10055	318	10114	227	10200	323	10269	325	10619	329
8647	37	8962	413	9721	265	9990	371	10056	318	10115	227	10201	323	10270	325	10620	329
8648	37	8963	413	9722	265	9993	487	10057	307	10116	227	10203	323	10271	325	10621	329
8649	37	8964	290	9723	265	9994	487	10058	318	10117	227	10205	323	10272	325	10622	329
8650	37	8965	290	9724	265	9995	486	10059	318	10118	229	10206	323	10273	325	10630	330
8651	37	8966	290	9725	265	9997	486	10060	315	10119	228	10207	323	10409	347	10632	330
8652	37	8967	290	9726	265	10000	304	10061	315	10120	228	10209	323	10410	347	10633	330
8653	37	8968	290	9727	265	10001	304	10062	314	10121	228	10210	323	10411	347	10634	330
8654	37	8969	290	9728	265	10002	304	10063	314	10122	228	10211	323	10412	347	10635	330
8655	30	8970	290	9729	265	10003	304	10064	313	10123	228	10212	323	10413	347	10636	330
8656	29	8971	290	9730	265	10004	304	10065	313	10124	229	10213	323	10414	347	10637	330
8680	263	8972	290	9731	265	10005	304	10066	313	10125	229	10214	324	10415	347	10638	330
8681	263	8973	290	9732	265	10006	304	10067	313	10126	229	10215	324	10416	345	10639	330
8682	263	8974	290	9733	265	10007	304	10068	313	10127	229	10216	324	10417	346	10640	330
8684	467	8975	290	9734	265	10008	305	10069	313	10128	227	10217	324	10418	349	10641	330
8685	469	8976	290	9735	265	10009	305	10070	313	10129	227	10218	324	10419	349	10642	134
8686	468	8977	290	9736	265	10010	305	10071	310	10130	227	10219	324	10420	349	10643	134
8687	468	8978	290	9737	265	10011	305	10072	310	10131	227	10220	324	10421	349	10644	134
8784	133	8979	290	9738	265	10012	305	10073	307	10141	323	10221	324	10422	349	10645	134
8785	133	8980	290	9739	265	10013	305	10074	227	10142	323	10222	324	10423	348	10646	134
8786	133	8981	290	9740	274	10014	305	10075	227	10143	323	10223	324	10424	348	10647	134
8787	133	8982	290	9741	274	10015	305	10076	227	10144	323	10224	324	10431	111	10648	371
8794	268	8983	290	9742	274	10016	206	10077	227	10145	323	10225	324	10432	322	10649	371
8795	133	8984	291	9743	274	10017	206	10078	229	10146	323	10226	324	10566	327	10650	273
8796	115	8985	291	9744	274	10018	206	10079	228	10147	322	10227	324	10567	327	10651	273
8797	116	8986	291	9745	274	10019	206	10080	228	10148	322	10228	324	10568	327	10652	273
8798	119	8987	291	9748	275	10020	206	10081	228	10149	322	10230	324	10569	327	10653	273
8799	117	8988	255	9749	275	10021	206	10082	228	10150	322	10231	324	10570	327	10654	273
8800	76	8989	255	9750	275	10022	308	10083	228	10151	322	10232	324	10571	327	10655	273
8803	77	9000		9751	275	10023	308	10084	229	10153	322	10233	324	10572	327	10656	273
8806	75	9626	136	9752	275	10024	308	10085	229	10154	322	10234	324	10573	327	10657	273
8809	381	9627	136	9753	275	10025	308	10086	229	10155	323	10235	324	10574	327	10658	273
8932	275	9628	136	9754	275	10027	308	10087	229	10157	323	10236	324	10575	327	10659	273
8933	275	9629	137	9760	268	10028	308	10088	231	10159	323	10237	324	10576	327	10668	357
8934	275	9630	137	9764	271	10029	308	10089	231	10160	323	10238	324	10577	327	10669	357
8935	260	9631	137	9765	271	10030	308	10090	231	10161	323	10239	324	10578	327	10670	357
8936	261	9632	275	9766	271	10031	308	10091	231	10162	323	10240	324	10579	327	10671	357
8937	260	9633	275	9767	271	10032	308	10092	228	10164	322	10241	324	10580	327	10672	358
8938	260	9653	142	9768	271	10033	308	10093	227	10166	322	10242	324	10581	327	10673	358
8939	261	9654	142	9769	271	10034	308	10094	227	10168	322	10243	325	10582	327	10674	359
8940	261	9655	142	9772	30	10035	309	10095	227	10170	322	10245	325	10583	327	10675	359
8941	260	9657	150	9773	29	10036	309	10096	227	10172	322	10247	325	10584	327	10676	359
8942	261	9658	150	9789	45	10037	309	10097	229	10173	322	10249	325	10585	327	10677	432
8943	261	9659	150	9791	47	10038	310	10098	228	10175	323	10251	325	10586	327	10678	432
8946	257	9660	150	9793	49	10039	311	10099	228	10176	323	10253	325	10587	327	10679	487
8947	257	9662	150	9795	51	10040	310	10100	228	10177	323	10255	325	10588	327	10680	487
8948	257	9663	150	9817	106	10041	310	10101	228	10179	322	10256	325	10589	327	10681	487
8949	257	9664	150	9969	468	10042	310	10102	228	10181	322	10257	325	10590	327	10682	487
8950	257	9665	150	9971	281	10044	307	10103	229	10183	322	10258	325	10591	329	10683	487
8951	257	9666	150	9972	281	10045	316	10104	227	10185	322	10259	325	10592	329	10684	432
8952	257	9709	409	9973	281	10046	317	10105	227	10187	322	10260	325	10593	329	10685	432
8953	257	9712	265	9974	281	10047	317	10106	227	10188	322	10261	325	10594	329	10686	432
8954	281	9713	265	9975	281	10048	317	10107	227	10190	322	10262	325	10595	329	10687	432

Índice referencia / Reference index

REF.	PAG.	REF.	PAG.	REF.	PAG.	REF.	PAG.	REF.	PAG.	REF.	PAG.	REF.	PAG.	REF.	PAG.	REF.	PAG.		
10839	327	10985	31	11061	339	11157	339	11517	441	11648	128	11799	365	11860	297	11965	389	M2161	146
10879	357	10986	31	11062	339	11158	339	11518	441	11649	128	11800	366	11861	297	11966	390	M2274	144
10880	357	10988	31	11063	339	11159	339	11519	441	11650	128	11801	366	11862	297	11967	390	M2275	144
10881	357	10989	31	11064	339	11160	339	11520	441	11651	128	11802	366	11863	297	11968	390	M2283	144
10882	357	10990	210	11065	339	11161	339	11521	441	11652	128	11803	366	11905	322	11969	390	M2297	146
10883	358	10991	210	11066	473	11162	339	11522	441	11653	128	11804	366	11906	116	11970	390	M2397	158
10884	358	10992	210	11067	206	11163	339	11523	441	11654	128	11805	366	11907	116	11971	390	M2710	146
10885	359	10993	210	11068	206	11164	339	11524	441	11657	244	11806	366	11908	117	11972	452	M2711	146
10886	359	10994	187	11069	206	11165	339	11525	441	11658	244	11807	366	11909	117	11973	485	M2712	146
10887	359	10997	181	11070	206	11166	339	11526	441	11659	245	11808	42	11910	119	11974	489	M2713	146
10897	286	10998	374	11071	206	11167	339	11527	441	11660	245	11809	266	11911	119	11975	493	M2714	146
10898	286	10999	374	11072	206	11168	339	11572	375	11661	245	11810	266	11912	325	11976	493	M2715	146
10899	286	11000	374	11076	340	11169	339	11573	375	11662	455	11811	266	11913	108	11977	493	M2716	146
10908	385	11001	374	11077	340	11170	373	11574	374	11663	455	11812	266	11914	108	11978	477	M2759	144
10909	385	11002	375	11078	340	11171	373	11575	374	11664	455	11813	266	11915	88	11987	203	M2760	144
10910	385	11003	375	11079	340	11172	373	11576	374	11665	455	11814	266	11916	88	11988	203	M2761	144
10928	134	11004	375	11083	245	11173	373	11577	374	11666	455	11815	266	11917	102	11989	295	M2762	144
10929	134	11005	375	11084	245	11174	373	11578	469	11667	455	11816	266	11918	102	11990	295	M2763	144
10930	134	11006	375	11085	245	11175	373	11579	469	11734	253	11817	266	11919	102	11991	390	M3036	166
10931	134	11007	375	11086	245	11176	373	11580	469	11735	253	11818	258	11920	102	11992	390	M3037	166
10932	134	11013	111	11087	245	11177	373	11581	469	11736	253	11819	263	11921	102	11996	281	M3038	166
10933	134	11014	331	11088	245	11178	373	11582	29	11737	253	11820	483	11922	102	11998	221	M3435	160
10934	387	11015	331	11089	322	11179	373	11583	29	11738	253	11821	483	11923	94	12000	181	M3950	152
10935	387	11016	374	11121	479	11180	373	11584	134	11748	256	11822	483	11924	94	12001	181	M3970	160
10936	387	11017	374	11122	479	11181	373	11585	223	11756	219	11825	483	11925	94	12002	485	M4306	152
10937	290	11018	206	11123	479	11482	473	11586	223	11758	219	11826	483	11926	94	12005	206	M4307	152
10938	290	11019	206	11124	479	11484	469	11587	223	11759	219	11827	255	11927	98	12006	165	M4540	160
10939	290	11022	240	11125	479	11485	469	11588	360	11760	219	11828	295	11928	158	12007	485	M4541	160
10940	290	11023	240	11126	479	11486	471	11590	360	11761	221	11829	295	11929	158	12008	113	M4542	160
10941	290	11024	240	11127	479	11487	471	11591	363	11762	345	11830	295	11930	150	12009	113	M4564	154
10942	290	11029	251	11128	479	11488	471	11592	363	11763	346	11831	301	11931	150	12010	113	M4591	158
10943	290	11030	251	11129	479	11489	469	11593	363	11764	347	11832	301	11932	153	12011	113	M4755	152
10944	291	11031	251	11130	479	11490	469	11599	286	11765	347	11833	301	11933	154	12012	113	M4756	152
10957	473	11032	251	11131	479	11491	469	11601	286	11766	350	11834	301	11934	154	12013	113	M4757	152
10958	358	11033	251	11132	479	11492	469	11602	330	11767	350	11835	301	11935	91	12014	493	M5084	144
10959	358	11034	251	11133	479	11493	471	11603	316	11768	483	11836	301	11936	91	12015	199	M5202	166
10960	358	11035	252	11134	479	11494	471	11604	311	11769	333	11837	301	11937	91	12016	199	M5203	166
10961	358	11037	251	11135	479	11495	471	11605	240	11770	333	11838	301	11938	91	12017	183	M5206	166
10964	239	11038	247	11136	479	11496	439	11606	240	11771	333	11839	295	11939	250	12018	183	M9332	162
10965	239	11039	337	11137	479	11497	441	11607	240	11773	331	11840	295	11941	221	12019	183		
10966	239	11040	337	11138	479	11498	439	11608	244	11774	331	11841	295	11942	181	12020	241		
10967	239	11041	337	11139	479	11499	438	11609	244	11775	331	11842	295	11943	366	12021	241		
10968	239	11042	337	11140	479	11500	438	11610	244	11776	268	11843	295	11946	259	12022	253		
10969	239	11043	337	11141	479	11501	438	11611	286	11777	271	11844	295	11947	259	12023	253		
10970	239	11044	337	11142	479	11502	438	11612	286	11778	281	11845	299	11949	271	12024	61		
10971	194	11045	340	11143	445	11503	438	11613	286	11780	287	11846	299	11950	271	12025	61		
10972	192	11046	340	11144	445	11504	438	11615	286	11781	287	11847	299	11951	287	12026	61		
10973	194	11047	340	11145	339	11505	438	11616	341	11782	287	11848	299	11952	287	12027	61		
10974	194	11048	337	11146	339	11506	438	11617	341	11787	287	11849	299	11953	287	12028	61		
10975	447	11049	337	11147	339	11507	441	11626	475	11788	287	11850	299	11954	287	12029	102		
10976	447	11050	337	11148	339	11508	438	11627	475	11789	287	11851	297	11955	287	12030	94		
10977	447	11051	337	11149	339	11509	438	11628	441	11790	287	11852	297	11956	333	12031	199		
10978	447	11052	337	11150	339	11510	439	11636	247	11791	287	11853	297	11957	112	12032	199		
10979	31	11053	337	11151	339	11511	441	11637	247	11792	287	11854	297	11958	112	12033	199		
10980	31	11054	340	11152	339	11512	441	11640	221	11794	287	11855	297	11959	113	12034	249		
10981	31	11055	340	11153	339	11513	440	11641	491	11795	287	11856	297	11960	113	M0010	160		
10982	31	11058	492	11154	339	11514	440	11645	128	11796	287	11857	297	11961	113	ABC			
10983	31	11059	339	11155	339	11515	440	11646	128	11797	365	11858	297	11962	112	M1462	154		
10984	31	11060	339	11156	339	11516	441	11647	128	11798	365	11859	297	11963	112	M1538	208		

Iconos / Icons



INOX STAINLESS STEEL 304
Inox AISI 304

INOX STAINLESS STEEL 430
Inox AISI 430

INOX STAINLESS STEEL 201
Inox AISI 201

CARBON STEEL
Acero de carbono
Carbon Steel

CORK
Corcho
Cork

ACRYLIC
Acrílico
Acrylic

ABS PLASTIC
ABS Plástico
ABS Plastic

PC POLYCARBONATE
Policarbonato
Polycarbonate

PP POLYPROPYLENE
Polipropileno
Polypropylene

EPP EXPANDED POLYPROPYLENE
Polipropileno expandido
Expanded polypropylene

HD PE 500
Poliétileno de alta densidad
High density polyethylene

NYLON
Nylon

SILICONE
Silicona
Silicone

RUBBER
Caucho
Rubber

THERMO PLASTIC RUBBER
Caucho termoplástico
Thermoplastic Rubber

STABILISED WOOD
Madera estabilizada
Stabilised wood

OAK WOOD
Madera de roble
Oak Wood

ZEBRA WOOD
Madera de zebrano
Zebra wood

ROSEWOOD WOOD
Madera de palisandro
Rosewood wood

PAKKA WOOD
Madera de pakka
Pakka wood

MIKARTA WOOD
Madera de mikarta
Mikarta wood

OLIVE WOOD
Madera de olivo
Olive wood

ACACIA WOOD
Madera de acacia
Acacia wood

BEECH WOOD
Madera de haya
Beech wood

BAMBOO WOOD
Madera de bambú
Bamboo wood

TRIPLE NON-STICK COATING
Triple capa antiadherente
Triple non-stick coating

SANDWICH BOTTOM SYSTEM
Fondo sistema sandwich
Sandwich bottom system

SLATE
Pizarra
Slate

COTTON
Algodón
Cotton

KRAFT
Kraft

PORCELAIN
Porcelana
Porcelain

ALUMINIUM
Aluminio
Aluminium

COPPER
Cobre
Copper

CAST IRON
Hierro fundido
Cast iron

ENAMELLED IRON
Hierro esmaltado
Enamelled iron

ZINC
Zinc

GLASS
Glass
Cristal

BOROSILICATE
Borosilicato
Borosilicate

FIBERGLASS
Fiberglass

PVD COLOR
Color PVD
PVD color

DESIGNED IN-HOUSE
Diseño propio
Designed in-house

MODULAR
Modular

SUITABLE FOR ELECTRIC COOKER
Apto para fogón eléctrico
Suitable for Electric Cooker

SUITABLE FOR OVEN
Apto para horno
Suitable for Oven

HAND WASH
Lavar a mano
Hand Wash

NO DIRECT FIRE
No fuego directo
No direct fire

SUITABLE FOR FREEZING
Apto para congelador
Suitable for Freezing

MAX. TEMPERATURE
Temperatura máxima
Max. temperature

MIRROR FINISH
Acabado brillo
Mirror finish

FOOD CONTACT NOT SAFE
No apto para contacto alimentario
Food contact not safe

NON-STICK COATING QUANTANIUM
Recubrimiento antiadherente
Quantanium
Non-stick coating Quantanium

STACKABLE
Apilable
Stackable

SUSTAINABLE
Sostenible
Sustainable

SUITABLE FOR CONVENTIONAL GAS COOKER
Apto para gas
Suitable for conventional Gas Cooker

SUITABLE FOR MICROWAVE
Apto para microondas
Suitable for Microwave

NOT SUITABLE FOR OVEN
No apto para horno
Not Suitable for Oven

MACHINE WASHABLE
Apto para lavadora
Machine Washable

HYDRATE WITH OLIVE OIL
Hidratar con aceite de oliva
Hydrate with Olive Oil

FOOD CONTACT SAFE
Apto para contacto alimentario
Food contact Safe

SATIN FINISH
Acabado satin
Satin finish

NON-TICK COATING
Recubrimiento non-stick
Non-tick coating

TRIPLE NON-STICK COATING
Triple capa antiadherente
Triple non-stick coating

LIGHTWEIGHT
Ligero
Lightweight

SUITABLE FOR VITROCERAMIC
Apto para vitrocerámica
Suitable for Vitroceramic

SUITABLE FOR INDUCTION COOKER
Apto para inducción
Suitable for Induction Cooker

DISHWASHER SAFE
Apto para lavavajillas
Dishwasher safe

NOT SUITABLE FOR MICROWAVE
No apto para microondas
Not Suitable for Microwave

UNTIL 80°C SUPPORT
Soporta hasta 80°C
Until 80°C suport

COMBINABLE WITH OTHER PRODUCTS IN THE CATALOG
Combinable con otros productos del catálogo
Combinable with other products in the catalog.

ANTI-SLIP
Antideslizante
Anti-slip

THICKNESS
Espesor material
Thickness

BBQ
BBQ

SANDWICH BOTTOM SYSTEM
Fondo sistema sandwich
Sandwich bottom system

**Si tienes alguna sugerencia o simplemente quieres saludarnos,
¡No dudes en contactarnos!**

For any suggestion or just to greet us, please do not hesitate to contact us!

comaspartners@comaspartners.com

**Y si lo que quieres es estar al corriente de nuestras noticias y novedades,
únete a nuestra comunidad online o suscríbete a nuestro newsletter:**

And if you want to be aware of our news and novelties, join our online
community or subscribe to our newsletter.

newsletter@comaspartners.com



@comasandpartners



@comasandpartners



@comas-and-partners

**El contenido del catálogo está sujeto a modificaciones.
Los datos técnicos y los precios son válidos salvo error tipográfico.**

Texts and images published on this catalogue may contain technical inconsistencies or
typographical errors. The information is subject to periodic changes.

